

# 109





# 109

Catalogue for household and commercial flat,  
dimple, cruciform, mail box and  
other special keys

Catalogo chiavi piatte per serrature a cilindro,  
chiavi punzionate, a croce, per ascensori  
e casellari postali

Flach-, Kreuzbart- und Bormuldenschlüssel,  
Lift- und Fachkastenschlüssel Katalog

Catalogue clés plates pour cylindres,  
clés à points, clés cruciformes, clés pour  
ascenseurs et casiers

Catálogo llaves planas para cilindro,  
llaves de seguridad, llaves en cruz, llaves  
para ascensores y casilleros postales

Catálogo das chaves planas para fechaduras  
de cilindro, chaves de ponto, chaves tetra,  
chaves para elevadores e caixas de correio





<b>IV</b>	Silca Website	<b>IV</b>	Sito internet Silca	<b>IV</b>	Silca Webseite
<b>V</b>	The Online Catalogue and MySica App	<b>V</b>	Catalogo Online e MySilca App	<b>V</b>	Online-Katalog und MySilca App
<b>VI</b>	Silky	<b>VI</b>	Silky	<b>VI</b>	Silky
<b>VII</b>	Art Keys	<b>VII</b>	Art Keys	<b>VII</b>	Art Keys
<b>VIII</b>	Ultralite	<b>VIII</b>	Ultralite	<b>VIII</b>	Ultralite
<b>IX</b>	Slim Color	<b>IX</b>	Slim Color	<b>IX</b>	Slim Color
<b>X</b>	Terminology	<b>X</b>	Terminologia	<b>X</b>	Terminologie
<b>XII</b>	Key Identification	<b>XII</b>	Identificazione Chiave	<b>XII</b>	Schlüsselidentifikation
<b>XIV</b>	Technical Information	<b>XIV</b>	Informazioni Tecniche	<b>XIV</b>	Technische Auskünfte
<b>XVIII</b>	Uses	<b>XVIII</b>	Utilizzi	<b>XVIII</b>	Verwendungen
<b>XX</b>	'Serie Distinzione' Heads	<b>XX</b>	Teste 'Serie Distinzione'	<b>XX</b>	Schlüsselköpfe der 'Serie Distinzione'
<b>XXVIII</b>	'Serie Distinzione' Slim Color	<b>XXVIII</b>	'Serie Distinzione' Slim Color	<b>XXVIII</b>	'Serie Distinzione' Slim Color
<b>XXX</b>	'Serie Distinzione' Color	<b>XXX</b>	'Serie Distinzione' Color	<b>XXX</b>	'Serie Distinzione' Color
<b>3</b>	Household Keys	<b>3</b>	Chiavi Piatte	<b>3</b>	Flachschlüssel
<b>225</b>	Dimple Keys	<b>225</b>	Chiavi Punzonate	<b>225</b>	Bohrmuldenschlüssel
<b>253</b>	Cruciform keys	<b>253</b>	Chiavi a Croce	<b>253</b>	Kreuzbartschlüssel
<b>269</b>	Mail Box and Lift Keys	<b>269</b>	Chiavi per Casellari e Ascensori	<b>269</b>	Fachkästen- und Liftschlüssel
<b>276</b>	General Index	<b>276</b>	Indice Generale	<b>276</b>	Generalverzeichnis



<b>IV</b>	Site Internet Silca	<b>IV</b>	Sitio Internet Silca	<b>IV</b>	Site Internet Silca
<b>V</b>	Catalogue Online et MySilca App	<b>V</b>	Catálogo Online y MySilca App	<b>V</b>	Catálogo Online e MySilca App
<b>VI</b>	Silky	<b>VI</b>	Silky	<b>VI</b>	Silky
<b>VII</b>	Art Keys	<b>VII</b>	Art Keys	<b>VII</b>	Art Keys
<b>VIII</b>	Ultralite	<b>VIII</b>	Ultralite	<b>VIII</b>	Ultralite
<b>IX</b>	Slim Color	<b>IX</b>	Slim Color	<b>IX</b>	Slim Color
<b>X</b>	Terminologie	<b>X</b>	Terminología	<b>X</b>	Terminologia
<b>XII</b>	Identification Clé	<b>XII</b>	Identificación de la Llave	<b>XII</b>	Identificação de uma Chave
<b>XIV</b>	Informations Techniques	<b>XIV</b>	Informaciones Técnicas	<b>XIV</b>	Informações Técnicas
<b>XVIII</b>	Utilisations	<b>XVIII</b>	Utilizaciones	<b>XVIII</b>	Utilizações
<b>XX</b>	Têtes 'Serie Distinzione'	<b>XX</b>	Cabezas 'Serie Distinzione'	<b>XX</b>	Cabeças 'Serie Distinzione'
<b>XXVIII</b>	'Serie Distinzione' Slim Color	<b>XXVIII</b>	'Serie Distinzione' Slim Color	<b>XXVIII</b>	'Serie Distinzione' Slim Color
<b>XXX</b>	'Serie Distinzione' Color	<b>XXX</b>	'Serie Distinzione' Color	<b>XXX</b>	'Serie Distinzione' Color
<b>3</b>	Clés Plates	<b>3</b>	Llaves Planas	<b>3</b>	Chaves Planas
<b>225</b>	Clés à Points	<b>225</b>	Llaves de Seguridad	<b>225</b>	Chaves de Pontos
<b>253</b>	Clés Cruciformes	<b>253</b>	Llaves en Cruz	<b>253</b>	Chaves Tetra
<b>269</b>	Clés pour Casiers et Ascenseurs	<b>269</b>	Llaves para Casillas y Ascensores	<b>269</b>	Chaves para Caixas de Correio e Elevadores
<b>276</b>	Index Général	<b>276</b>	Indice General	<b>276</b>	Índice Geral



## Silca Website

**EN** - Contains complete information on all Silca products including keys, key cutting machines, automotive solutions and complementary products. Find out the latest news on support tools and accessories; download brochures and keep your 109 catalogue updated with the Silca New Key Collection; all at [www.silca.biz](http://www.silca.biz).

**IT** - Tutte le informazioni sui prodotti Silca - chiavi e macchine duplicatrici, soluzioni automotive e prodotti complementari - sono facilmente consultabili all'interno del sito [www.silca.biz](http://www.silca.biz). Potrai inoltre scaricare mensilmente i Bollettini Silca News e la Raccolta Nuove Chiavi Silca da allegare al catalogo 109 e tenerlo sempre aggiornato.

**DE** - Alle Informationen zu den Silca-Produkten - Schlüssel und Schlüsselfräsmaschinen, Lösungen für Fahrzeugschlüssel - sind einfach über die Internetseite [www.silca.biz](http://www.silca.biz) abzurufen. Außerdem haben Sie die Möglichkeit, monatlich die Silca News und die Sammlung der neuen Silca-Schlüssel herunterzuladen, mit dem Sie den Katalog 109 ergänzen und aktualisieren können.

**FR** - Toutes les informations sur les produits Silca - clés et machines à reproduire les clés, solutions automotive et produits complémentaires - sont facilement consultables sur notre site [www.silca.biz](http://www.silca.biz). Vous pourrez en outre télécharger tous les mois nos Bulletins Silca News et la Collection Nouvelles Clés Silca à annexer au catalogue 109 pour qu'il soit ainsi toujours à jour.

**ES** - Toda la información sobre los productos Silca - llaves y duplicadoras, soluciones automotive y productos complementarios - se puede consultar fácilmente entrando en el sitio [www.silca.biz](http://www.silca.biz). Asimismo, podrás bajarte mensualmente los Boletines Silca News y la Colección Nuevas Llaves Silca, que adjuntar al catálogo 109, para mantenerlo siempre al día.

**PT** - Todas as informações sobre os produtos Silca - chaves e máquinas duplicadoras, soluções automotive e produtos complementares - podem ser consultadas facilmente no site [www.silca.biz](http://www.silca.biz). Também poderá descarregar mensalmente os Boletins Silca News e a Coleção Novas Chaves Silca a anexar ao catálogo 109 para o manter sempre atualizado.

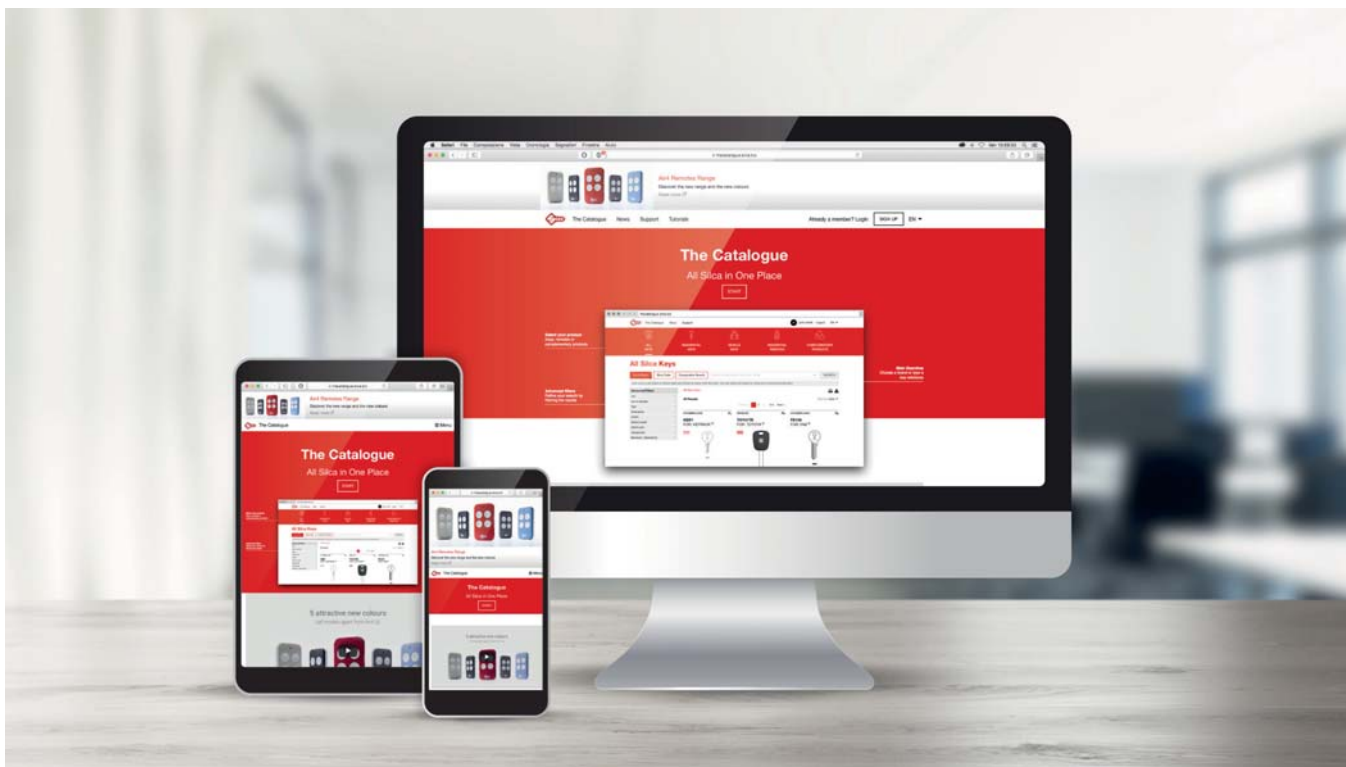

# The Online Catalogue and MySilca App

**EN** - The world's most complete database for all types of keys whether residential, commercial or automotive. The breadth and quality of the information available make this the essential tool to find the key you need. Register at [thecatalogue.silca.biz](http://thecatalogue.silca.biz).

Install the free MySilca App on your mobile and have all the essential Silca information at your fingertips, whenever and wherever you need it.

**FR** - The Catalogue est le data base le plus complet de clés résidentielles et automotive au monde. La quantité et la qualité des informations qu'il contient en font un instrument essentiel pour repérer facilement n'importe quel type de clé. Enregistrez-vous sur [thecatalogue.silca.biz](http://thecatalogue.silca.biz).

Installez l'app gratuite MySilca et vous aurez toutes les informations nécessaires indispensables à votre travail toujours et partout.

**IT** - The Catalogue è il più completo database di chiavi ad uso residenziale e automotive al mondo. La quantità e la qualità delle informazioni in esso contenute lo rendono lo strumento essenziale per individuare facilmente qualsiasi tipologia di chiave. Registrati su [thecatalogue.silca.biz](http://thecatalogue.silca.biz).

Installa l'app gratuita MySilca e avrai tutte le informazioni necessarie a svolgere il tuo lavoro a portata di mano, in qualsiasi momento, ovunque tu sia.

**ES** - The Catalogue es la base de datos más completa de llaves para el uso residencial y el sector automovilístico del mundo entero. Por la cantidad y la calidad de la información contenida en ésta, es una herramienta esencial para identificar fácilmente una tipología de llave. Regístrate en [thecatalogue.silca.biz](http://thecatalogue.silca.biz).

Instala la app gratis MySilca para tener al alcance toda la información necesaria para desarrollar tu trabajo en todo momento y en todos lados.

**DE** - The Catalogue ist die weltweit umfassendste Datenbank für Wohn- und Fahrzeugschlüssel. Die Menge und die Qualität der in der Datenbank enthaltenen Informationen machen sie zu einem wesentlichen Instrument, um jede Art von Schlüssel einfach zu erkennen. Melden Sie sich auf [thecatalogue.silca.biz](http://thecatalogue.silca.biz) an.

Installieren Sie die kostenlose App MySilca, damit Sie jederzeit und überall alle für Ihre Arbeit erforderlichen Informationen bei der Hand haben.

**PT** - The Catalogue é o banco de dados mais completo no mundo para chaves de utilização residencial e automotive. A quantidade e a qualidade das informações nele contidas tornam-no no instrumento essencial para individualizar facilmente qualquer tipo de chave. Registe-se em [thecatalogue.silca.biz](http://thecatalogue.silca.biz).

Instale a app gratuita MySilca e terá ao alcance da mão todas as informações para realizar o seu trabalho, em qualquer momento, em qualquer lugar se encontrar.



AVAILABLE COLOURS:



## Silky

**EN** - Combining design and quality, Silky keys are available for a wide range of popular references, including both flat and dimple key types. Choose from five different colours; green, blue, pink, red and orange. Silky keys can be customized on request. Check the 109 Index on page 276 to see which key references are available with the Silky head.

**IT** - Le chiavi Silky coniugano design e qualità e sono disponibili per un'ampia gamma di referenze chiavi fra le più comuni, sia piatte che punzonate. È possibile scegliere fra cinque colori standard: verde, blu, rosa, rosso e arancione. La chiavi Silky possono essere personalizzate su richiesta. Consulta l'Indice a pagina 276 per conoscere tutti gli articoli disponibili nella finitura Silky.

**DE** - Die Silky-Schlüssel verbinden Design und Qualität und sind in einer breiten Palette für die am häufigsten verwendeten Referenzschlüssel erhältlich, sowohl für Flach- als auch für Bohrmuldenschlüssel. Zur Auswahl stehen fünf Standardfarben: grün, blau, rosa, rot und orange. Die Silky-Schlüssel können auf Anfrage personalisiert werden. Sehen Sie im Verzeichnis auf Seite 276 nach, welche Artikel in der Silky-Version erhältlich sind.

**FR** - Les clés Silky allient design et qualité et sont proposées dans une vaste gamme, à savoir les clés les plus communes plates et à points. Disponible en cinq couleurs standard : vert, bleu, rose, rouge et orange. Les clés Silky sont personnalisables sur demande. Voir la Table des Matières page 276 pour découvrir tous les articles proposés en finition Silky.

**ES** - Las llaves Silky conjugan diseño y calidad y están disponibles en una gama amplia de referencias de llaves entre las más comunes, ya sean planas o punzonadas. Se puede elegir entre cinco colores estándares: verde, azul, rosa, rojo y naranja. Las llaves Silky se pueden personalizar bajo pedido. Consulta el índice de la página 276 para ver todos los artículos disponibles con el acabado Silky.

**PT** - As chaves Silky conjugam design e qualidade e estão disponíveis numa ampla gama de referências chave entre as mais comuns, planas e de pontos. É possível escolher entre cinco cores: verde, azul, cor-de-rosa, vermelho e laranja. As chaves Silky também podem ser personalizadas por encomenda. Consulte o Índice na página 276 para conhecer todos os artigos disponíveis no acabamento Silky.





# Art Keys

**EN** - Creative and colourful the Silca Art Keys range includes fresh patterns like fruit, flowers, flamingos and cakes and themes that stretch from the wild west to the street art world. Silca Art Keys are made to the highest quality standards guaranteed by Silca and have a finish that stays looking new.

**IT** - Divertenti e variopinte le chiavi Silca Art Keys renderanno unico e inconfondibile il mazzo di chiavi dei tuoi clienti. Ispirate alle fantasie dei fumetti e dei graffiti, al mondo degli animali e ai soggetti di tendenza del momento, le chiavi Art sono realizzate secondo gli elevati standard di produzione Silca, garantendo nel tempo la qualità della finitura.

**DE** - Die witzigen und bunten Silca Schlüssel Art Keys sorgen für einen einzigartigen und unverwechselbaren Schlüsselbund Ihrer Kunden. Die Art Keys, die von den Motiven der Comics und der Graffiti, der Tierwelt und im Trend liegenden Motiven inspiriert sind, werden gemäß den hohen Produktionsstandards von Silca gefertigt, wodurch eine langanhaltende Qualität der Endbearbeitung garantiert wird.

**FR** - Amusantes et bariolées, les clés Silca Art Keys rendront unique et incomparable le trousseau de clés de vos clients. S'inspirant à l'imagination des BD et des graffitis, au monde animal et aux sujets tendance du moment, les clés Art sont fabriquées selon les hauts standards de production Silca, donc la qualité des finitions est garantie dans le temps.

**ES** - Con las llaves Silca Art Keys, divertidas y variopintas, los llaveros de llaves de tus clientes serán únicos e inconfundibles. Las llaves Art, inspiradas en las fantasías de los dibujos animados y de los grafitos, en el mundo de los animales y en los personajes y temas de moda, están realizadas en cumplimiento de estándares elevados de producción Silca, para garantizar la calidad del acabado a largo plazo.

**PT** - Divertidas e coloridas, as chaves Silca Art Keys tornarão único e inconfundível o molho de chaves dos seus clientes. Inspiradas nas fantasias das bandas desenhadas e dos graffiti, no mundo dos animais e nos padrões na moda, as chaves Art são realizadas de acordo com os elevados níveis de produção Silca, garantindo a qualidade do acabamento ao longo do tempo.



AVAILABLE COLOURS:



## Ultralite

**EN** - Silca Ultralite Keys are made of a special aluminium alloy, chosen because of its combination of lightness and strength; in fact, so strong and light that it's widely used in the aerospace industry. Seven colours are available: red, green, blue, yellow, black, sky blue, violet. In the 109 catalogue Ultralite keys are identified on page 276.

**IT** - Le chiavi Silca Ultralite sono realizzate con una speciale lega di alluminio che unisce leggerezza e resistenza. Il materiale con cui sono prodotte è infatti largamente impiegato nell'industria automobilistica, aeronautica e ferroviaria. Le chiavi Ultralite sono disponibili in sette colori (rosso, verde, blu, giallo, nero, azzurro, viola) nelle referenze indicate a pagina 276.

**DE** - Die Silca Ultralite-Schlüssel werden aus einer speziellen Aluminiumlegierung gefertigt, die sich durch Widerstandsfähigkeit und Leichtigkeit auszeichnet. Das Material, aus dem sie produziert werden, kommt viel in der Automobil-, Luftfahrt und Eisenbahnindustrie zum Einsatz. Die Ultralite-Schlüssel sind in sieben verschiedenen Farben (rot, grün, blau, gelb, schwarz, hellblau, violett) in den auf Seite 276 angegebenen Referenzen lieferbar.

**FR** - Les clés Silca Ultralite sont fabriquées dans un alliage d'aluminium spécial qui unit légèreté et résistance. Ce matériau est d'ailleurs largement utilisé dans l'industrie automobile, aéronautique et ferroviaire. Les clés Ultralite sont proposées en 7 couleurs (rouge, vert, bleu, jaune noir, bleu-ciel, violet) dans les articles indiqués page 276.

**ES** - Las llaves Silca Ultralite están realizadas con una aleación especial de aluminio, que conjuga ligereza y resistencia. De hecho, el material de producción se emplea ampliamente en la industria automovilística, aeronáutica y ferroviaria. Las llaves Ultralite están disponibles en siete colores ) en las referencias indicadas en la página 276.

**PT** - As chaves Silca Ultralite são realizadas com uma liga de alumínio especial que une ligeireza e resistência. O material com que são produzidas, de facto, é muito utilizado na indústria automobilística, aeronáutica e ferroviária. As chaves Ultralite estão disponíveis em sete cores (vermelho, verde, azul, amarelo, preto, azul, violeta) nas referências indicadas na página 276.



AVAILABLE COLOURS:



## Slim color

**EN** - The range of 5 colours help your customers easily identify their key without having the inconvenience of a bulkier product. Silca Slim Color keys are made in the most common flat and dimple key references and can be ordered in different head shapes, as indicated on page XXVIII. See which key references are available in Slim Color in the Index on page 276.

**IT** - Questa serie, disponibile in cinque colori, aiuterà i tuoi clienti ad identificare agevolmente chiavi con utilizzi diversi. Le chiavi Silca Slim Color sono disponibili per un'ampia gamma di chiavi piatte e punzonate. Possono avere forme diverse della testa, come indicato a pagina XXVIII. Scopri per quali chiavi è disponibile questa finitura nell'Indice a pagina 276.

**DE** - Diese Serie, die in fünf Farben lieferbar ist, hilft Ihren Kunden, verschiedene Schlüssel untereinander einfach zu unterscheiden. Die Slim-Color-Schlüssel sind für eine breite Palette an Flach- und Bohrmuldenschlüssel erhältlich. Es sind auch verschiedene Kopfformen möglich, siehe hierzu Angaben auf Seite XXVIII. Sehen Sie auf Seite 276 nach, für welche Schlüssel diese Endbearbeitung erhältlich ist.

**FR** - Série proposée en cinq couleurs qui aidera vos clients à identifier sans problème les clés selon l'usage. Les clés Silca Slim Color sont disponibles dans une vaste gamme de clés plates et à points. La forme de leurs têtes peut différer comme indiqué page XXVIII. Découvrez les clés disponibles dans cette finition dans la Table des Matières page 276.

**ES** - Esta serie, disponible en cinco colores, ayudará a tus clientes a identificar fácilmente llaves con usos distintos. Las llaves Slim Color están disponibles para una gama amplia de llaves planas y de seguridad. La cabeza puede presentar formas distintas como se indica en la página XXVIII. Descubre en el índice de la página 276 para qué llaves está disponible este acabado.

**PT** - Esta série, disponível em cinco cores, auxiliará os seus clientes a identificar facilmente chaves com utilizações diferentes. As chaves Silca Slim Color estão disponíveis para uma ampla gama de chaves planas e de pontos. Podem ter formas da cabeça diferentes, como indicado na página XXVIII. Descubra para quais chaves está disponível este acabamento no Índice da página 276.

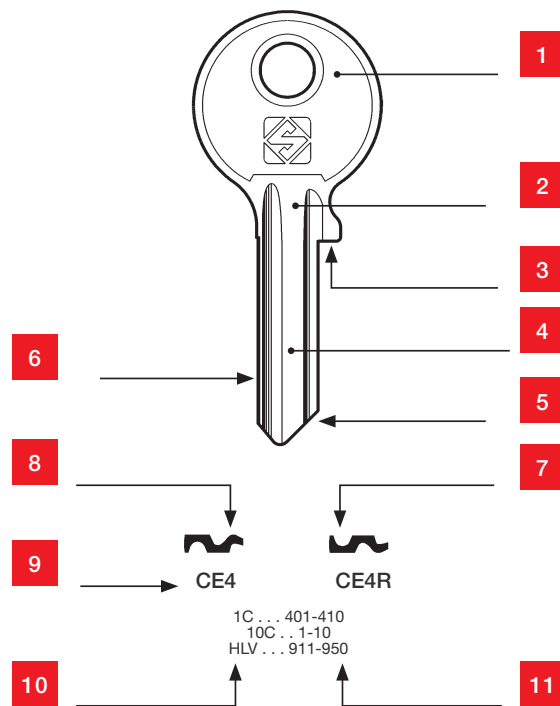

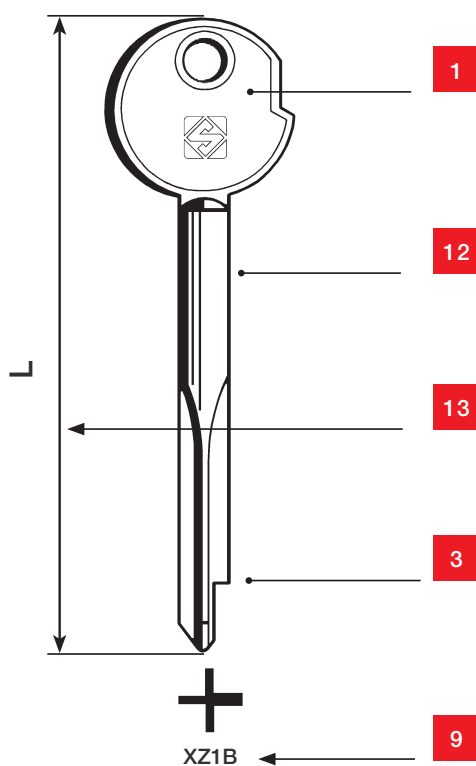

1	Head	Testa	Kopf
2	Neck	Collo	Hals
3	Shoulder	Fermo	Anschlag
4	Blade (stem)	Canna	Stange
5	Tip	Punta	Spitze
6	Back	Dorso	Rücken
7	Left hand profile	Profilo sinistro	Linkes Profil
8	Right hand profile	Profilo destro	Rechtes Profil
9	Silca item	Art. Silca	Silca-Artikel
10	Original profile	Profilo originale	Originalprofil
11	Code	Serie	Serie
12	Stem	Gambo	Halm
13	Length	Lunghezza	Nötige Länge



Tête	Cabeza	Cabeça	1
Cou	Cuello	Colo	2
Arrêt	Tope	Encosto	3
Canon	Caña	Cana	4
Pointe	Punta	Ponta	5
Dos	Dorso	Dorso	6
Profil gauche	Perfil izquierdo	Perfil esquerdo	7
Profil droit	Perfil derecho	Perfil direito	8
Article silca	Artículo silca	Artigo silca	9
Profil original	Perfil original	Perfil original	10
Code	Serie	Códigos	11
Canon	Pala	Haste	12
Longueur	Longitud	Comprimento	13

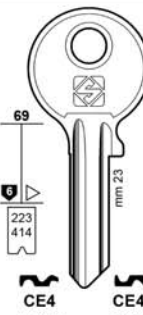
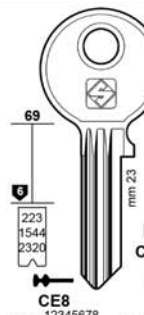
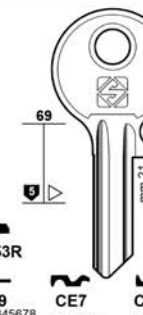
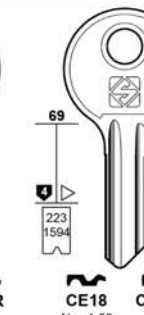

**PER: FOR:** **CES**

 255 mm 27,5 <b>CE147</b>	 69 mm 23 <b>CE4</b>	 69 mm 23 <b>CE8</b>	 69 mm 21 <b>CE9</b>	 69 mm 18 <b>CE18</b>
CE6 ELZETT FRECOV HÄFELE HANNO JOSTA KARDEX KIND KNAPP MAUSER NEMEF OJMAR VOKO WASO WECO	CE6R BODA ELZETT FRECOV KNAPP	CE4R BODA ELZETT FRECOV KNAPP	CE153R CE9 FRECOV HÄFELE HANNO JOSTA KARDEX KIND KNAPP MAUSER NEMEF OJMAR VOKO WASO WECO	CE7R BODA FRECOV KNAPP OJMAR



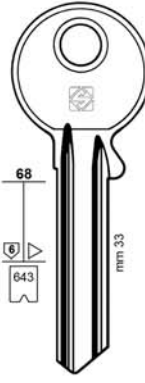
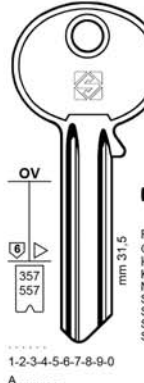
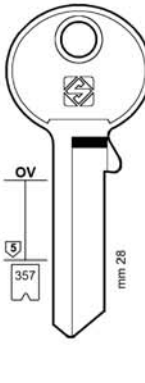

47

**PER: FOR:** **CES**

 68 mm 33 <b>CE3</b>	 OV mm 31,5 <b>CE1</b>	 OV mm 28 <b>CE5</b>	 OV mm 28 <b>CE2X</b>
1-2-3-4-5-6-7-8-9-0 BODA	CE1R FUHR GIESCHE HÖHRMANN KIMA NEMEF SIEBAU SOLID SS STUV	CE2R SOLID TORE	CE2 BERRY COMBA FEFI HÄFELE HÖHRMANN MBB NEMEF OTIS SANTIS SOLID STUV TORE TRITON

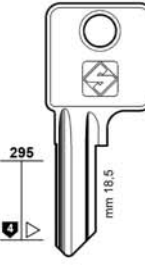
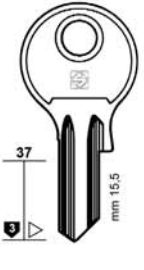

**PER: FOR:** **CES**

 295 mm 18,5 <b>CE33</b>	 37 mm 15,5 <b>CE13</b>	 2 mm 15 <b>CE11</b>	 385 mm 15 <b>CE19</b>	 215 mm 15 <b>CE30</b>
CE13R ELZETT FRECOV HÄFELE HANNO JOSTA KARDEX KIND KNAPP MAUSER NEMEF OJMAR VOKO WASO	CE11R BOTT	CE19R	CE30R	



Copyright by Silca S.p.A. 2018 - All Rights Reserved

XII

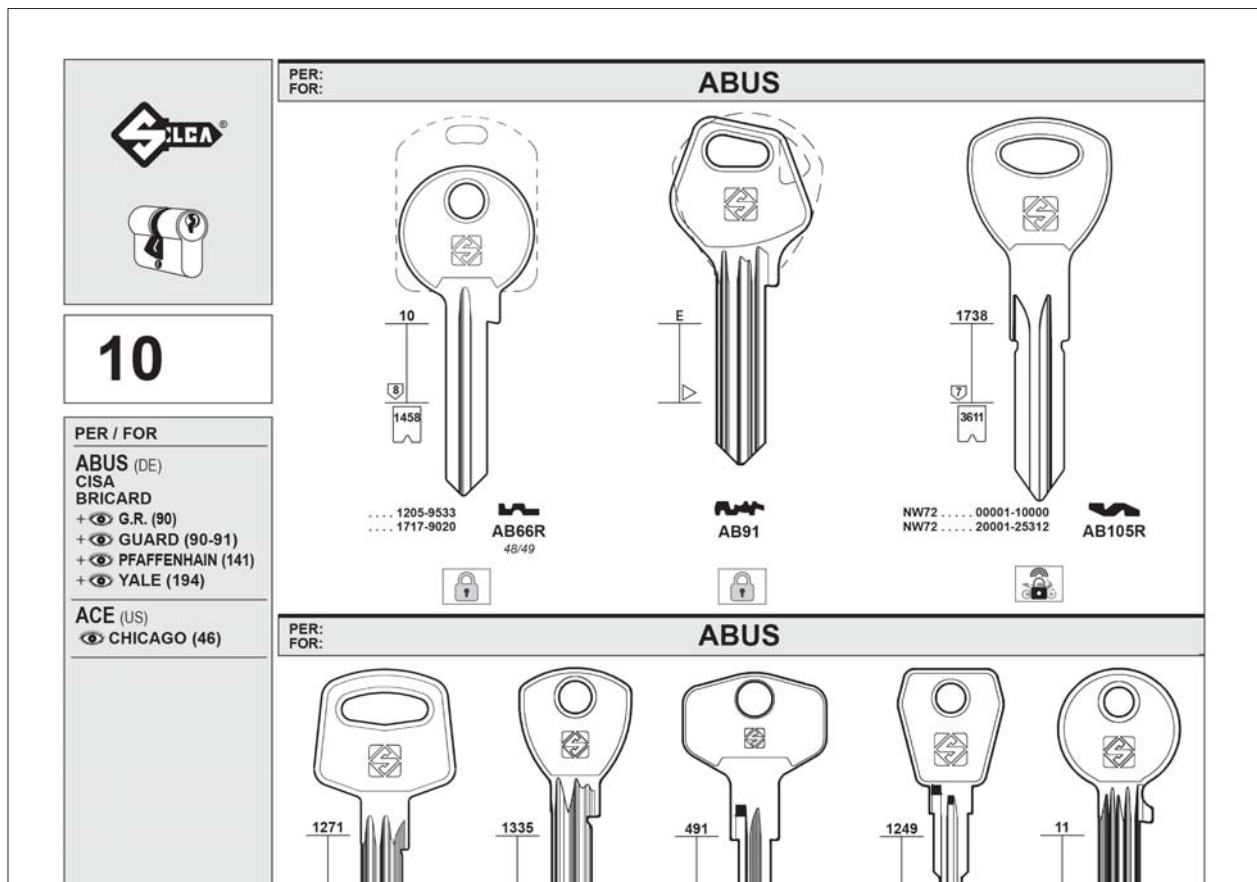

### Keys are drawn to a 1:1 scale

EN - Identification of a key may be made by laying the sample on the drawing, paying particular attention to the blade and to the profile.

Alternative head shapes are indicated by the dashed outlines around the standard head.

### I disegni delle chiavi sono in scala 1:1

IT - I profili (sezione della canna) sono visti dalla testa.

Per la ricerca basta sovrapporre la chiave campione al disegno esaminando particolarmente la canna (gambo) e la sezione (profilo).

Teste originali diverse sono rappresentate con linea tratteggiata.

### Die Zeichnungen der Schlüssel sind in Skala 1:1

DE - Die Profile (Schnitt der Stange) werden vom Kopf ab gesehen. Für die Suche genügt es den Musterschlüssel mit der angegebenen Zeichnung zu vergleichen, aber wir empfehlen, besonders die Stange und das Profil zu überprüfen.

Verschiedene Originalköpfe sind durch gestrichelte Linien dargestellt.

### Les dessins des clés sont à échelle 1:1

FR - Les profils (section du canon) sont vus de la tête.

Pour la recherche il suffira de superposer la clé échantillon au dessin en examinant tout particulièrement le canon (tige) et la section (profil).

Têtes originales différentes sont représentées par des lignes en tirets.

### Los dibujos de las llaves son en escala 1:1

ES - Los perfiles (sección de la caña) son vistos de la cabeza. Para la búsqueda basta sobreponer la llave de muestra al dibujo, examinando con particular atención la caña y la sección (perfil).

Las cabezas originales diferentes están representadas con una línea punteada.

### Os desenhos das chaves estão em escala 1:1

PT - Os perfis (secção da cana) são vistos da cabeça.

Para uma pesquisa eficiente, basta sobrepor a chave original por cima do desenho e examinar atentamente a cana da chave e o perfil.

Cabeças originais diferentes estão representadas com uma linha tracejada.

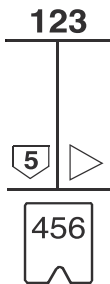

### Technical Information

EN - Technical characteristics including the key head reference, number of pins and the cutting card code are indicated alongside each key. Standard materials and special finishes available for each reference are indicated in the Index on page 276.

### Informazioni Tecniche

IT - Le caratteristiche tecniche, come la testa chiave, il numero di spine o la scheda di taglio, sono indicate a lato di ciascuna chiave. I materiali di produzione standard e le finiture in cui è possibile ordinare ciascuna referenza sono riassunti nell'Indice a pagina 276.

### Technische Informationen

DE - Die technischen Merkmale, wie der Schlüsselkopf, die Anzahl der Plättchen oder die Schnittkarte, sind seitlich von jedem Schlüssel angegeben. Die Standardproduktionsmaterialien und Endbearbeitungen, die für jede Referenz bestellt werden können, sind zusammenfassend in dem Verzeichnis auf Seite 276 angegeben.

	TECHNICAL FEATURES	CARATTERISTICHE TECNICHE	TECHNISCHE MERKMALE
<b>123</b>	Head-shape code adjacent to each key for easy identification of customized coining dies	Codice testa per facilitare la scelta di conii personalizzati	Kopf-Code, um die Auswahl der Prägungen zu erleichtern
<b>5</b>	Number of big pins	Nr. spine grandi	Nr. grosse Dornen
<b>5</b>	Number of small pins	Nr. spine piccole	Nr. kleinen Dornen
<b>▶</b>	Back milled profile	Profilo dorsato	Rückengefrästes Profil
<b>456</b>	Card number for cutting by code on Silca electronic machines for flat keys	Numero scheda per riproduzione a codice con macchine elettroniche Silca per chiavi piatte	Kartennummer für die Kopierung nach Code auf Silca elektronische Schlüsselkopiermaschine für Flachschlüssel
<b>S56</b>	Silca serial number for cutting by code on Silca electronic machines for dimple and laser keys	Silca serial number per riproduzione a codice su duplicatrici elettroniche Silca per chiavi punzonate e laser	Silca Serial Number für die Kopierung nach Code auf Silca elektronische Schlüsselkopiermaschine für Bohrmulden- und Bahnschlüssel





### Informations Techniques

FR - Les caractéristiques techniques, comme la tête de la clé, le nombre de goupilles ou la fiche de taillage sont indiquée à côté de chaque clé. Les matériaux de production standard et les finitions pour chaque article clé sont indiqués dans la Table des Matières page 276.

### Información Técnica

ES - Las características técnicas, tales como cabeza llave, número de agujas o ficha de corte, se indican junto a cada llave. Los materiales de producción estándar y los acabados disponibles para cada referencia aparecen sintetizados en el índice de la página 276.



### Informações Técnicas

PT - As características técnicas, como a cabeça da chave, o número de pivos ou a ficha de corte, estão indicadas ao lado de cada chave. Os materiais standard de produção e os acabamentos em que é possível encomendar cada referência estão resumidos no Índice da página 276.

123



CARACTÉRISTIQUES TECHNIQUES	CARACTERÍSTICAS TÉCNICAS	CARACTERÍSTICAS TÉCNICAS	
Code de la tête pour faciliter le choix des frappes personnalisées	Código de la cabeza para facilitar la elección de acuñaciones personalizados	Código da cabeça para facilitar a escolha dos cunhos personalizados	<b>123</b>
Nr. grands pistons	Nr. de agujas grandes	Nr. de pivos grandes	<b>5</b>
Nr. petits pistons	Nr. de agujas pequenas	Nr. de pivos pequenos	<b>5</b>
Profil à chiffrage dorsal	Perfil lomeado	Perfil boleado no dorso	
Numéro de fiche pour la reproduction à code sur machines électroniques Silca pour clés plates	Número de la ficha para la reproducción a código con duplicadoras electrónicas Silca para llaves planas	Número de ficha técnica para a duplicação pelo código nas máquinas electrónicas Silca (chaves planas)	<b>456</b>
Silca serial number pour la reproduction à code sur machines électroniques Silca pour clés a points et laser	Silca serial number para la reproducción a código con duplicadoras electrónicas silca para llaves de seguridad y de regata	Silca serial number para a duplicação pelo código nas máquinas eletrónicas Silca para chaves de pontos e laser	<b>S56</b>



















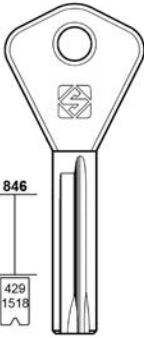

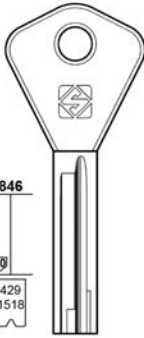

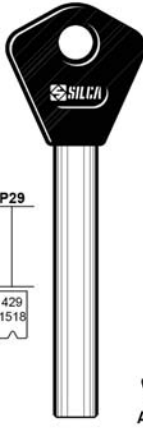



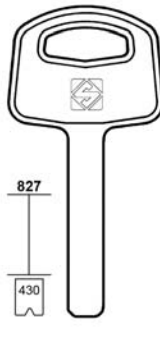

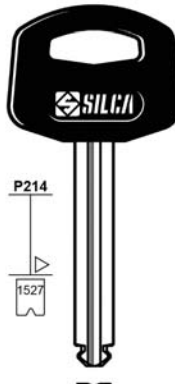

6

**PER / FOR**

**ABLOY (FI)**

**ABT (IT)**  
 VIRO (206)

**ABUS (DE)**  
 CISA  
 JPM  
 OTHMER  
 TOP  
 +  CISA (55-56-57)  
 +  G.R. (90)  
 +  GUARD (90-91)  
 +  PFAFFENHAIN (141)  
 +  YALE (194)

ABLOY		
 846 429 1518 <b>AY28</b> RAB 	 846 429 1518 <b>AY29</b> RAG 	 P29 429 1518 <b>AY10P</b> 
	..... DX ..... (DX) ..... (SX) 0-1-2-3-4-5-6-7-8-9	
ABUS		
 827 430 <b>AB32</b> 1-2-3-4-5-6 <b>GRANIT</b> 	 P214 584 716 1519 <b>AB38P</b> 1-2-3-4-5-6 <b>ABUS PLUS</b> 	 P214 1527 <b>AB60P</b> 1-2-3-4-5-6
		
ABUS		
 <b>A31R</b> 1-2-3-4-5-6	 <b>AB10R</b> F3 BCISS ..... 1-6032 F20 ..... 1,6032	 <b>AB8</b>
	 <b>AB8R</b>	 <b>A136</b>
	 <b>AB36R</b>	 <b>JM1</b> <small>CS</small>
	 <b>JM1R</b> <small>CS</small>	

**EN** - The main uses of each key are indicated by an intuitive icon below the profile of the key

**FR** - Les utilisations principales de chaque clé sont illustrées par des icônes faciles à interpréter sous le profil de la clé

**IT** - Gli utilizzi principali di ciascuna chiave sono indicati tramite icone di facile lettura sotto il profilo della chiave stessa

**ES** - Los usos principales de cada llave se indican con iconos de fácil lectura bajo el perfil de dicha llave

**DE** - Die Hauptverwendungen für jeden Schlüssel sind mit leicht verständlichen Symbolen unter dem Profil des Schlüssels angegeben

**PT** - As utilizações principais de cada chave estão indicadas por meio de ícones fáceis de ler por baixo do perfil da própria chave

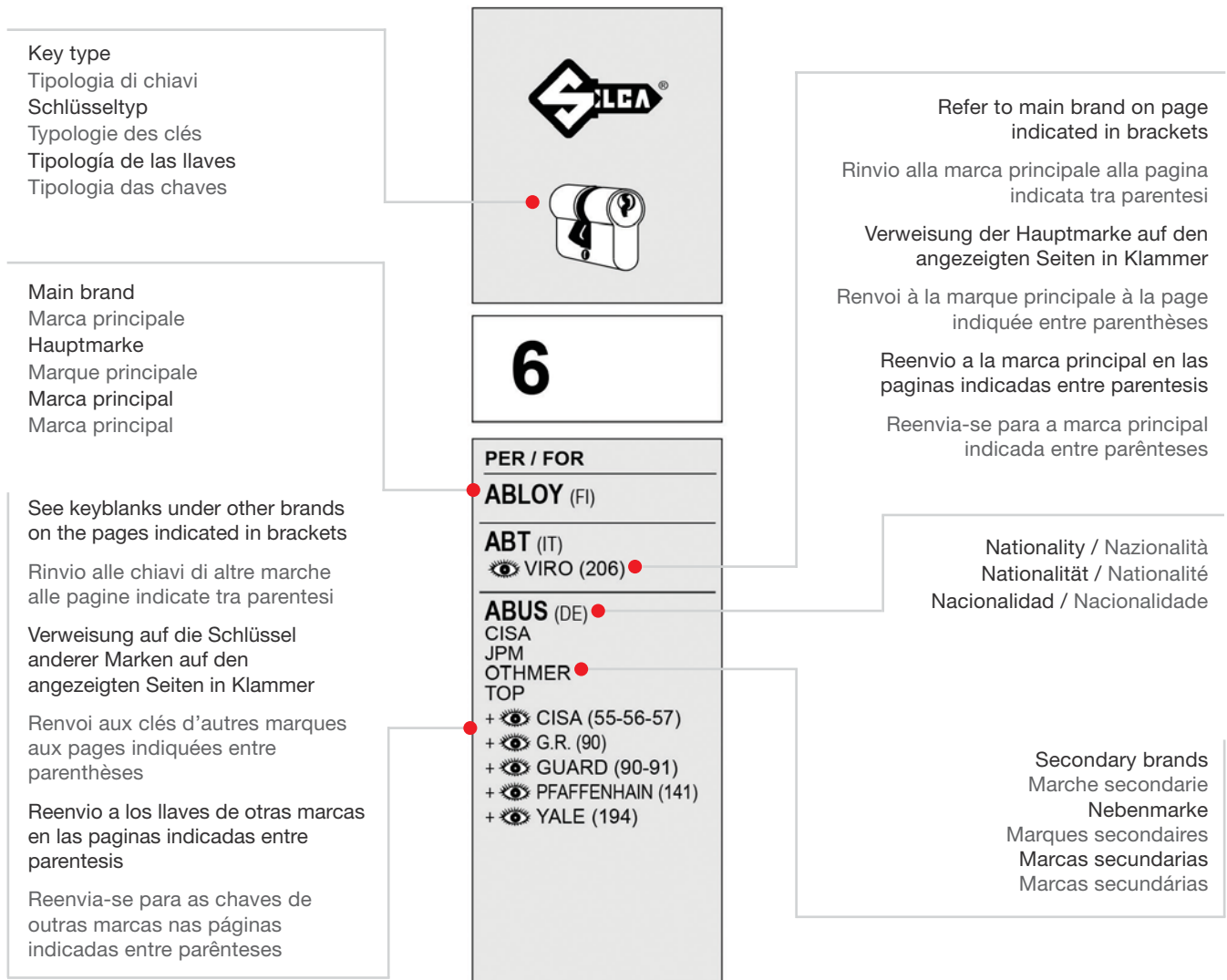

















**Nationality / Nazionalità / Nationalität / Nationalité / Nacionalidad / Nacionalidade**

AR	Argentina	DZ	Algeria	IE	Ireland	RO	Romania
AT	Austria	DE	Germany	IL	Israel	RS	Serbia
AU	Australia	DK	Denmark	IN	India	RU	Russia
AZ	Azerbaijan	DZ	Algeria	IT	Italy	SA	Saudi Arabia
BE	Belgium	EE	Estonia	JP	Japan	SE	Sweden
BG	Bulgaria	EG	Egypt	LT	Lithuania	SI	Slovenia
BR	Brazil	ES	Spain	LV	Latvia	TN	Tunisia
BY	Belarus	FI	Finland	MD	Republic of Moldova	TR	Turkey
CA	Canada	FR	France	ME	Montenegro	TW	Taiwan
CH	Switzerland	GB	Great Britain	NG	Federal Rep.of Nigeria	UA	Ukraine
CL	Chile	GR	Greece	NL	The Netherlands	US	United States of America
CN	China	HK	Hong-Kong	NO	Norway	VE	Venezuela
CO	Colombia	HR	Croatia	PL	Poland	ZA	Republic of South Africa
CZ	Czech. Repub.	HU	Hungary	PT	Portugal	ZM	Zambia

EN - The wide range of Silca articles allows you to copy keys for various uses, such as padlocks, furniture locks, safes, electric boards, shutter locks and many more. At the end of the catalogue there are specific sections dedicated to dimple, cruciform and mail box keys.

IT - La gamma di articoli Silca consente di duplicare chiavi per i più disparati utilizzi come lucchetti, cilindri per mobili, cassette di sicurezza, quadri elettrici, serrature per serranda e molti altri. Alla fine del catalogo sono presenti inoltre delle sezioni specifiche dedicate alle chiavi punzionate, alle chiavi a croce e alle chiavi per casellari postali.











DE - Das Sortiment der Silca-Artikel ermöglicht das Fräsen von Schlüsseln für die unterschiedlichsten Verwendungen wie Schlösser, Zylinder für Möbel, Safes, Schaltschränke, Rollläden und viele andere mehr. Am Ende des Katalogs befinden sich spezifische Abschnitte für Bohrmulden-, Kreuzbart-, und Fachkastenschlösser.

	USES	UTILIZZI	VERWENDUNGEN
	Padlocks	Lucchetti	Vorhangschlösser
	Security cylinders	Cilindri di sicurezza	Sicherheitszylinder
	Electric boards	Quadri elettrici	Schalttafel
	Mail boxes	Casellari postali / Cassette per lettere	Fachkasten
	Cash register locks	Registratori di cassa	Registriermaschine
	Furniture locks	Cilindri per mobili	Möbelzylinder
	Steering column locks	Bloccasterzo	Lenkschlösser
	Shutter locks	Serrature per serranda	Fallturschlösser
	Phone locks	Blocca telefono	Telefonschlösser
	Glass door locks	Blocca cristalli	Glasschiebetürschlösser
	Locomotives	Locomotive	Lokomotive
	Briefcases	Valigette	Köfferchen
	Safes	Cassette di sicurezza	Sicherheitsfach
	Lifts	Ascensori	Aufzüge
	Juke box / Flipper	Juke box / Flipper	Juke box / Spielautomaten
	Bicycle	Biciclette	Fahrrad
	Antitheft devices for motorcycles	Antifurto per ciclomotori / motociclette	Diebstahlschutz für Motorrad und Motorräder

FR - La gamme d'articles Silca permet de reproduire des clés pour les usages les plus disparates comme les chaînes, les cylindres pour meubles, les coffres, les tableaux électriques, les serrures de rideaux métalliques et bien d'autres encore. À la fin du catalogue vous trouverez aussi des chapitres dédiés aux clés à points, cruciformes et pour boîtes postales.

ES - La gama de artículos Silca permite duplicar las llaves para los usos más dispares, tales como candados, cilindros para muebles, cajas de seguridad, cuadros eléctricos, cerraduras para cierres y otros muchos. El catálogo contiene al final también secciones específicas dedicadas a las llaves de seguridad, en cruz y para casilleros postales.

PT - A gama de artigos Silca permite duplicar chaves para as utilizações mais diferentes, como cadeados, cilindros para móveis, caixas de segurança, quadros eléctricos, fechaduras para grades e outras ainda. No fim do catálogo também se encontram secções específicas dedicadas às chaves de pontos, tetra e para caixas de correio.

UTILISATIONS	UTILIZACIONES	UTILIZAÇÕES	
Cadenas	Candados	Cadeados	
Cylindres de sécurité	Cilindros de seguridad	Cilindros de segurança	
Tableaux électriques	Cajas eléctricas	Quadros eléctricos	
Boîtes postales / Boîtes aux lettres	Casillas postales / Buzones	Caixas de correio	
Caisse enregistreuse	Registradoras de caja	Caixas registradoras	
Cylindres pour meubles	Cilindros para muebles	Cilindros para mobiliário	
Blocage volant	Bloqueo para direcció	Bloqueios da direcção	
Serrures pour stores métalliques	Cerraduras para cortinas metálicas	Fechaduras para grades de enrola	
Blocage du téléphone	Bloqueo para teléfonos	Bloqueios de telefone	
Blocage porte en verre	Bloqueos para cristales	Trava dos vidros	
Locomotive	Locomotora	Locomotivas	
Mallettes	Maletines	Maletas	
Coffres-forts	Caja de seguridad	Cofres	
Ascenseurs	Ascensores	Elevadores	
Juke box / Flipper	Juke box / Flipper	Juke box / Flipper	
Vélo	Bicicleta	Bicicleta	
Antivols pour cyclomoteurs / motocyclettes	Antihurto para ciclomotores y motocicletas	Anti-roubo para scooters e motocicletas	

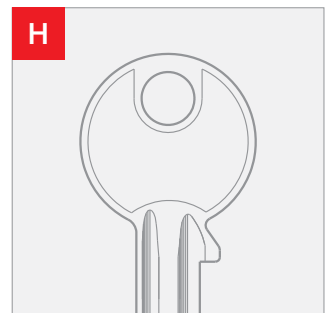
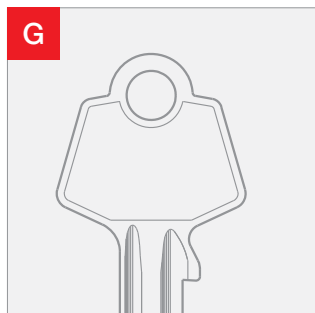
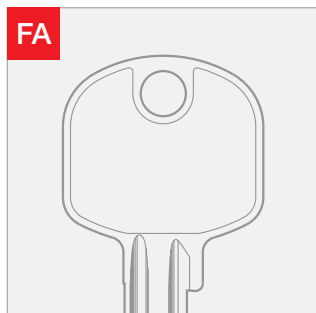
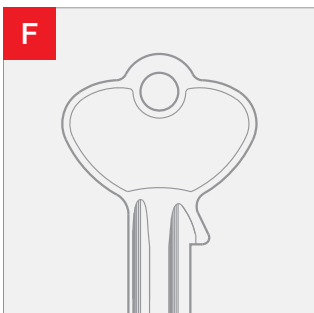
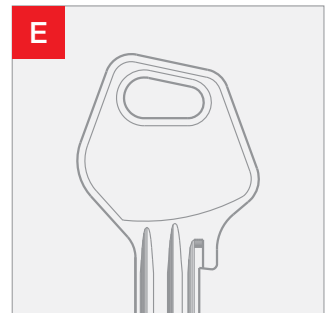
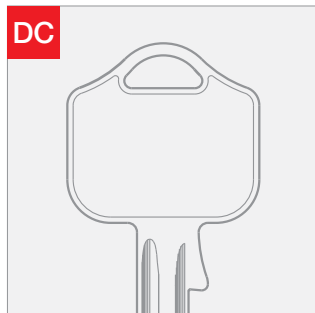
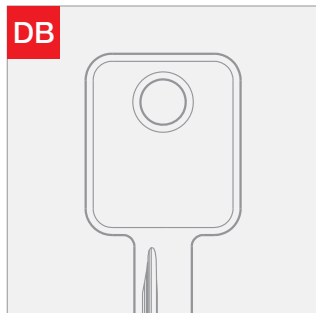
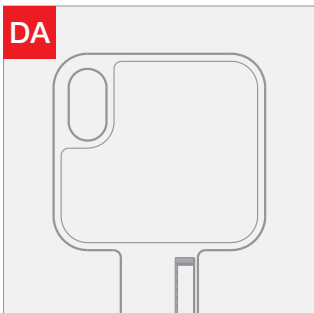
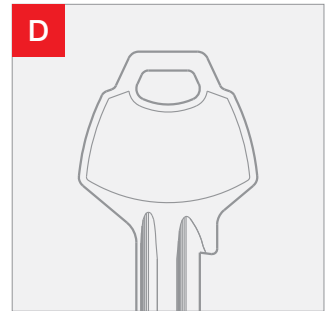
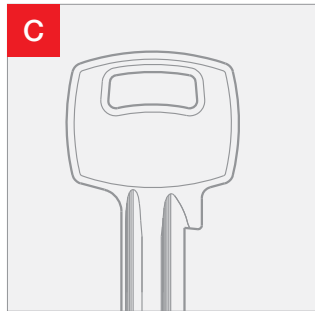
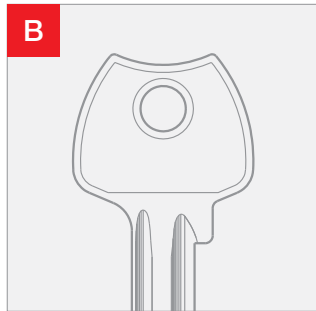
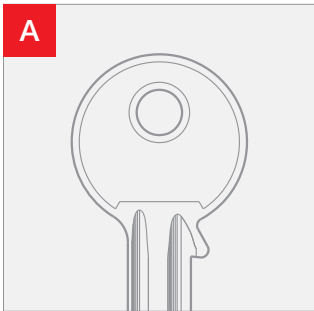

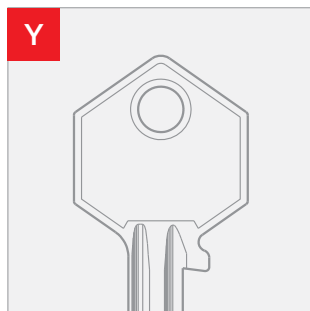
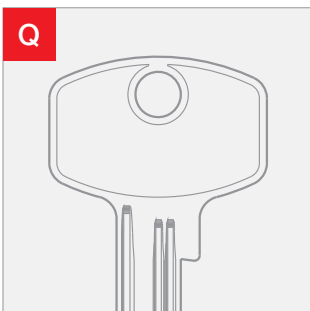
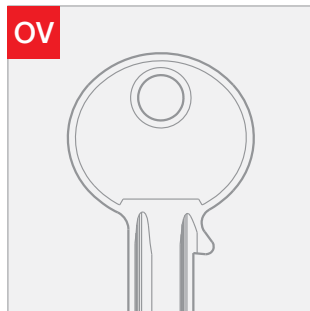
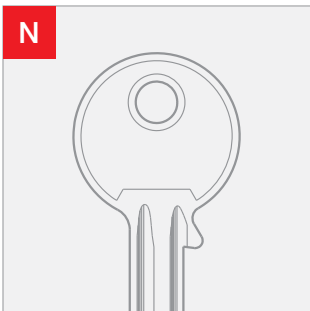
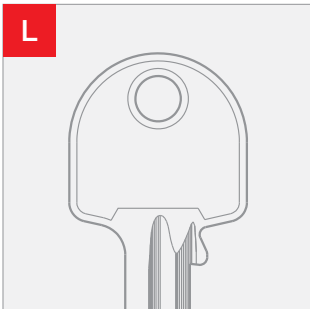

**EN** - With the Silca 'Serie Distinzione' you will be able to customize your keys with your logo and the contact details of your shop, choosing from 18 different heads and a wide range of keys.

**IT** - Con la 'Serie Distinzione' Silca potrai personalizzare le tue chiavi con il logo e i recapiti del tuo negozio, scegliendo fra 18 teste diverse e un'ampia gamma di referenze.

**DE** - Mit der 'Serie Distinzione' können Sie Ihre Schlüssel mit dem Logo und den Daten Ihres Geschäftes personalisieren. Zur Auswahl stehen 18 verschiedene Köpfe und eine breite Referenzpalette.

**FR** - La 'Serie Distinzione' Silca vous permettra de personnaliser vos clés avec le logo et l'adresse de votre magasin dans les 18 têtes différentes d'une vaste gamme d'articles.

**ES** - Con la 'Serie Distinzione' Silca, podrás personalizar tus llaves con el logo y los datos de tu tienda; elige entre 18 cabezas distintas y una gama amplia de referencias.

**PT** - Com a 'Serie Distinzione' Silca, poderá personalizar as suas chaves com o logotipo e os recados da sua loja, escolhendo entre 18 cabeças diferentes e uma ampla gama de referências.

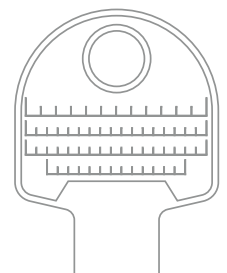

A								
	AA1	CS15R	FH13	JW7R	MN7	PF18	TO26	WA1R
	AA1R	CS204	FH15	JW8	MN7R	PF210	TP1	WA2
	AA5	CS205	FH18	JW9	MON1	PF211	TP1R	WA2R
	AA5R	CS206	FH8R	JW9R	MON1R	PF2S	TP2	WA6
	AA6	CS207	FI6	KAK1	MP228	PF7	TP2R	WA6R
	AA6R	CS33	FM090	KEI1R	MP229	PF7S	TR2	WE1
	AAA1	CS33R	FM2	KK1	MP230	PF8	TRM2	WE13
	AB14	CS38	GD2	KLE3R	MP231	PF8R	TRM3	WE13R
	AB14R	CS68	GO1R	KLE3RX	MSF1	PG1	TS1	WE14
	AB54	CS7	GO2R	KLE3X	MTA1R	PG1R	TS2	WE14R
	AG2	CS70	GS7	KLE5RX	MTA3R	PT2	TU1	WE15
	AG2R	CT1	GSS1	KLE5X	MTA4	RIQ9	UAP2	WE15R
	AG3	CT1R	HDL3	KLE6RX	MTK5	RIQ9R	UL046	WE16
	AG3R	CT2	HDL3R	KLE6X	MTK5R	RM1A	UL047	WE16R
	AG4	CT2R	HE1	KLE7RX	NF1	RM1RA	UL048	WE1R
	AG4R	CVL1	HE1R	KLE7X	NF1R	RM2A	UL049	WE2
	AG7	CVL1R	HE3	KM1	OA2	RM2RA	UL050	WE2R
	AG7R	CVL3	HE3R	KM1R	OA2R	RZA3	UL051	WE5
	AGB1R	CVL3R	IB1	LD4	OA3	SCM4	UL052	WE5R
	AKR9R	CVL4	ICS1	LD4R	OA3R	SE7	UL053	WE6
	ALM1	DEA2	ICS1R	LD5R	OL1	SE7R	UL054	WE6R
	ALM1R	DM32	ICS2	LN1	OL1R	SIL1	UL055	WE7
	AMC1R	DO1R	ICS2R	LP13	OL2	SIL1R	UL058	WE7R
	AMC2R	EA1	ICS3	LP13R	OL2R	SN3R	UL059	WMS1
	AMC3	ECM1	ICS3R	LP20R	OL3	SN4R	UL062	WMS2
	AZ2	ECM1R	IE6	LP5	OL3R	SO4	UL063	WR1
	AZ2R	EL1	IE8	LP5R	OL4	SO7	UL064	WR2
	AZ2X	EN2R	IE8R	LP7	OL4R	SO8R	UM2	YA1
	AZ4	ER2	IL1	LP7R	OL5	SQ4R	UNI3	YA226
	BAI5R	ER3R	IL1R	LT2	OL5R	SS12	VAC29	YA31
	BAL7	EVO1	ILS1	MG1	OL6	STA1	VI080	YA31R
	BD2	F2R	JOW8	MG1R	OL6R	STA1R	VI081	YA6
	BD2R	FAM1	JS1	MG2	OV1	STA2	VI082	YAR1
	BE200	FAM1R	JS1R	MG2R	OV1R	STA2R	VI083	YT15
	BE202	FAM2	JW1	MG3	OV2	STA3	VI086	ZA2R
	BI110	FAM2R	JW10	MG3R	OV2R	STA3R	VI1	ZI1
	BM1	FB108	JW10R	MI1	PC1	SVN2	VI10	ZI1R
	BM2	FB26	JW11	MI1R	PC10	TAR11	VI10R	ZI2
	BR1	FB26R	JW12	MI2	PC10R	TAR11R	VI11	ZI2R
	BS1	FEB1	JW13	MI2R	PC14	TAR4	VI12	ZI4
	CA10	FEB1R	JW13R	MI5	PC18R	TAR4R	VI13	ZI4R
	CA10R	FEB2	JW1R	MI5R	PC1R	TAR5	VI1R	ZI5
	CB20	FEB2R	JW2	MIG1	PC20	TAR5R	VI2	ZI5R
	CB5	FF1	JW2R	MIG1R	PC26	TAR9	VI23	
	CB6	FF1R	JW3	MIG2	PC27	TAR9R	VI2R	
	CB78R	FF2	JW3R	MIG2R	PC31R	TG1	VI6	
	CB83	FF7	JW4	MN1	PC32R	TL11	VI9	
	CC1	FF7R	JW4R	MN2	PC33	TL11R	VI9R	
	CEE1	FF8	JW5	MN2R	PC33R	TL13	VL2	
	CLS242	FF8R	JW5R	MN3	PC4	TN16	VL2R	
	CLS3	FF9	JW6	MN3R	PC4R	TN16X	VL3	
	COR1	FF9R	JW6R	MN4	PF092	TN2	VL3R	
	CS121	FH10R	JW7	MN4R	PF092S	TN39	WA1	

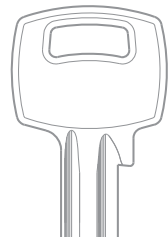

<b>B</b> 	CS204	IE2R	UL051
	CS205	LW1	UL052
	CS206	LW1R	UL053
	CS207	MG1R	WA1
	EL1	UL050	WA1R

<b>C</b> 	ADT1	IB1	VI082
	CS204	UL050	VRF3
	CS205	UL051	VRF4
	CS206	UL052	WA1R
	CS207	UL053	WA2R
	EL1	VI080	

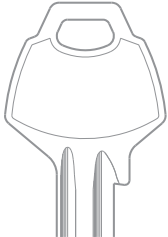
<b>D</b> 	CS204	EL1	UL050
	CS205	JL2	UL051
	CS206	JL2R	UL052
	CS207	PC9	UL053

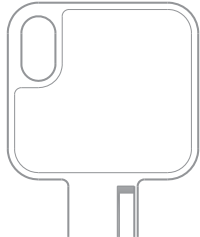
<b>DA</b> 	AB1	CS207	TO30R
	BK1	DM119	UL050
	CS206	MTA3R	

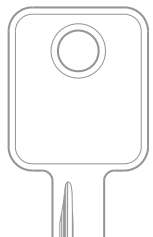
<b>DB</b> 	AB3	BUR2	DM8
	AB3R	BUR2R	HN1
	BA2	CE4	HW1
	BA2R	CE7	JU1
	BUR1	CS7	JU1
	BUR1R	DM10	YA8

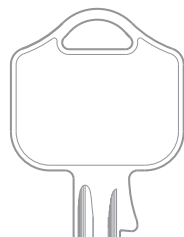
<b>DC</b> 	LW4	UL050	UL051
---	-----	-------	-------

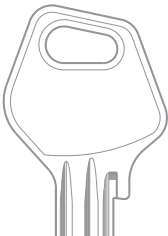
<b>E</b> 	AB91	FM1	JL5	VL2R
	BK26	FM6	PC13	VL5
	CB6	FM7	PC27	VL5R
	CS204	IB1	PC28	WST1
	CS205	JL3	UL050	WTR1R
	CS206	JL3R	UL051	
	CS207	JL4	UL052	
	EL1	JL4R	UL053	

<b>F</b> 	CS204	EL1	UL051
	CS205	UL050	UL052
	CS206		

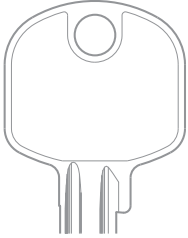
**FA**

AB1	CS24	TN19R
AB1RX	DM14	TN23
AB1X	EV10	TO1
BAI1	GR3	TOP1R
BD3	IB1	TOP1RX
BD3R	IE6	UL050
BD9R	IE6R	UL050X
BK1	JM1	UL051
CA2	JM2R	VAC151
CB6	LH42	VAC2
CE2	LT2	VAC48
CE2X	RO41	WK1
CS13	RO8	YA1
CS206	TE2	YA226
CS207	TE8X	

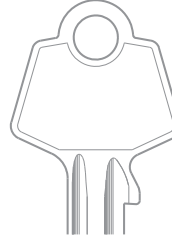
**G**



CB6	PF2
CS204	UL050
CS205	UL051
CS206	UL052
CS207	UL053
EL1	

**H**

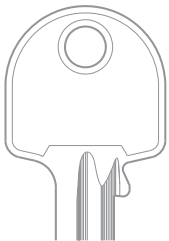
CS206	MN8
CS207	MN8R
DS5R	MN9
FF10	MN9R
FF10R	UL050
FF2	UL052
FF3	WA7
FF3R	WA7R

**L**

AB1R	CE2	EV69X	HUT1	PF092S	UL053	YA31
AB1X	CE20	EZ2R	IB1	PF2	UL054	YA6
AB36	CE2X	FAC7	IE12	PF212	UL054SL	YT15
AB36R	CE41	FB13R	IE2	PF2S	UL055	YT16
AB54	CS13X	FB13RX	IE6	STL1R	UL058SL	ZE12X
AB63	CS143	FB15R	JOW10	TE2	UL062	ZE1RX
AE2R	CS204	FB15RX	JS2	TE2X	UL063	ZE1X
AG3	CS205	FB19R	KF1	TE6	UL064	
AG3R	CS206	FB19RX	LC11	TN16X	UNI3	
AGA6	CS207	FB20R	LC11R	TN2	VAC2	
AGB1R	CS68	FB20RX	LC2	TO1X	VI080	
AGB2R	CV1	FB21R	LC2R	TO30R	VI081	
ASEC1	CV3	FB21RX	LP21	TO30RX	VI082	
ASEC2	CVL1R	FB22R	LP5	TOP1R	VL2R	
AZ2	CVL3R	FB22RX	LT2	TOP1RX	WA1	
AZ2R	CYS1	FB25R	LT4	UC1R	WA1R	
AZ2X	DM119	FB25RX	LW4	UL050	WA2R	
BAB13	DM14	FB28R	LW5	UL050SL	WE2R	
BK1X	DM151R	FB28RX	MC12	UL050X	WE11	
BK5-16	DM3X	FDR2	MC2	UL051	WK1X	
BK5-6	EL1	FF2	MC2R	UL051SL	WMS1	
BRM1	EV10	FH31L	MER8	UL051X	YA1	
CB6	EV10X	GE1	MXU2	UL052	YA1E	
CB6X	EV4	GE106	PF092	UL052SL	YA226	

<div style="background-color: red; color: white; padding: 2px; text-align: center; font-weight: bold;">M</div> 	AE1R BNL1R CS204 CS206 IB1 KS1 MIL2 UL050	UL051 UL052 UL053 VI080 VI082 WA1R YA1E YA226	<div style="background-color: red; color: white; padding: 2px; text-align: center; font-weight: bold;">N</div> 	BD17 BSI1 BSI1R BSI2 BSI2R BSI4 BSI4R CA1 CA9 CB15 CB3 CB85 CC1 CC1R CEN2 CEN2R CS7 CS7R FF14 FF17 FF18	GL3 GL3R GL4 GL4R IE1 IE1R IE28R IE3 IE3R JB1 JL1 JOW4R JU1 JU1R MN5 MN5R MTY1 MTY2 NE34 OB1 OC074	PA2 PA2R PF070 PF9 RGM1 RGM1R RR10R RR2 RR2R RR3 RR4 RR6 RR8R RX1 STA8 STA8R TAR3 TAR3R TAR8 TAR8R TRE2	UL056 UL057 UL058 UL059 UL060 UL061 VI084 VI085 VI086 VI087 WE3 WE3R WK3 YD4 YD4R YT13 YT13R YT7 YT7R ZI3 ZI3R

<div style="background-color: red; color: white; padding: 2px; text-align: center; font-weight: bold;">OV</div> 	AB10 AB101RX AB10RX AB1RX AB1X AB4 AB5 AB55X AB6 AB68X AB69X AB70X AB79RX AB8 AB88X AL1 AL1R ARE1 ASS186 AZ5 BAB31 BAI23 BAL1 BAL1R	BG1 BK1 BK13 BK1R BK1X BK21R BK22R BK23R BK27 BK2R BK3-1 BK3-10 BK3-11 BK3-12 BK3-2 BK3-3 BK3-4 BK3-5 BK3-6 BK3-7 BK3-8 BK3-9 BK48R BK49R	BK5-1 BK5-10 BK5-11 BK5-12 BK5-13 BK5-14 BK5-15 BK5-16 BK5-17 BK5-18 BK5-19 BK5-2 BK5-20 BK5-21 BK5-22 BK5-23 BK5-24 BK5-25 BK5-26 BK5-27 BK5-28 BK5-29 BK5-3 BK5-30	BK5-31 BK5-32 BK5-33 BK5-34 BK5-35 BK5-4 BK5-5 BK5-6 BK5-7 BK5-8 BK5-9 BK6-1 BK6-10 BK6-11 BK6-12 BK6-13 BK6-14 BK6-15 BK6-16 BK6-17 BK6-18 BK6-19 BK6-2 BK6-20	BK6-21 BK6-22 BK6-23 BK6-24 BK6-25 BK6-26 BK6-27 BK6-28 BK6-29 BK6-3 BK6-30 BK6-31 BK6-32 BK6-33 BK6-34 BK6-35 BK6-4 BK6-5 BK6-6 BK6-7 BK6-8 BK6-9 BK7R-1 BK7R-10	BK7R-2 BK7R-3 BK7R-4 BK7R-5 BK7R-6 BK7R-7 BK7R-8 BK7R-9 BLA1 BLA2 BLA3 BRT1 BRT2 BRT3 BRT4 BVA1 BVA1R BY1 C1 C1R CB104R CB106 CB6 CB6X	CE1 CE17WPS CE1R CE2 CE20 CE2R CE2X CE41 CE5 CO1 CO1R CS13X CS163X CS206 CS207 CS52X DF3 DF3R DM105R DM11 DM119 DM123-1 DM123-10 DM123-2	DM123-3 DM123-4 DM123-5 DM123-6 DM123-7 DM123-8 DM123-9 DM25 DM28 DM3 DM35R DM3X DM48 DM7 DO6 EM11 ER1 ERT1 ET1 ET1R ET2 ET2R EV10X EV3

OV





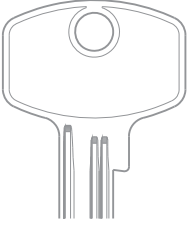





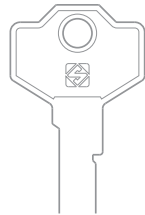

EV69X	KF1	ORA2	TO30R	TO8X13	UL050	WK27	YA9
FAM6	KFA	RG1	TO30RX	TO8X14	UL050X	WK28	YYA
FB35R	KFB	RO8	TO30X	TO8X15	UL051	WK29	YYA6
FH16R	KFC	RU1	TO31R	TO8X16	UL051X	WK2R	YYB
FH30	KFD	RU10R	TO34	TO8X17	UNI28	WK30	YYB6
FS1	KFE	RU11R	TO39R	TO8X18	UP1	WK31	YYC
FS1R	KFF	RU12	TO4	TO8X2	VAC151	WK32	YYC6
FV1	KFG	RU13	TO5	TO8X3	VAC30	WK33	YYD
GD8	KFH	RU16	TO54-1	TO8X4	VAC30R	WK34	YYD6
GD8R	KFI	RU19	TO54-13	TO8X5	VG1	WK35	YYE
GE1	KFJ	RU1R	TO54-14	TO8X6	VYA	WK36	YYE6
GOD4R	KFK	RU2	TO54-16	TO8X7	VYA6	WK37	YYF
GR1R	KFL	RU20	TO54-17	TO8X8	VYB	WK38	YYF6
GR9-5	KFM	RU21	TO54-18	TO8X9	VYB6	WK39	YYG
GR9-7	KFN	RU22R	TO54-19	TO9RY1	VYC	WK4	YYG6
GR9-8	KFO	RU23R	TO54-2	TO9RY10	VYC6	WK40	YYH
GR9-9	KFR	RU28	TO54-20	TO9RY11	VYD	WK41R	YYH6
GR9R-1	KFS	RU29R	TO54-21	TO9RY12	VYD6	WK42R	YYK
GR9R-2	KFU	RU2R	TO54-23	TO9RY13	VYE	WK43R	YYK6
GR9R-3	KFW	RU3	TO54-24	TO9RY14	VYE6	WK44R	YYP5A
GR9R-4	KFX	RU30	TO54-3	TO9RY15	VYF	WK45R	YYP5B
GR9R-5	LH4	RU3R	TO54-4	TO9RY16	VYF6	WK45X	YYP5D
GR9R-6	LH42	RU4	TO54-5	TO9RY17	VYG	WK46	YYP6A
GV7	LP21	RU4R	TO54-6	TO9RY18	VYG6	WK47R	YYP6B
GYA	LP5	RU5	TO54-7	TO9RY2	VYH	WK48	YYP6D
GYA6	LW24	RU5R	TO54-8	TO9RY3	VYH6	WK5	ZE1
GYB	LYA	RU6	TO6	TO9RY4	VYK	WK52R	ZE10
GYB6	LYA6	RU7	TO7	TO9RY5	VYK6	WK53R	ZE10R
GYC	LYB	RU8R	TO75R	TO9RY6	VYP5A	WK54R	ZE12
GYC6	LYB6	RU9R	TO81R	TO9RY7	VYP5B	WK56R	ZE12X
GXD	LYC	SAN1	TO82R	TO9RY8	VYP5D	WK57	ZE13
GXD6	LYC6	SAN1R	TO8RX1	TO9RY9	VYP6A	WK6	ZE13R
GYE6	LYD	SEI10	TO8RX10	TO9Y1	VYP6B	WK62R	ZE15
GYF	LYD6	SHW1	TO8RX11	TO9Y10	VYP6D	WK6R	ZE16
GYF6	LYE	ST1	TO8RX12	TO9Y11	WK1	WK7	ZE1R
GYG	LYE6	STL1RX	TO8RX13	TO9Y12	WK10	WK71X	ZE1RX
GYG6	LYF	STU1	TO8RX14	TO9Y13	WK11	WK87X	ZE1X
GYH	LYF6	SV3	TO8RX15	TO9Y14	WK12	WK9	ZE2
GYH6	LYG	SV3R	TO8RX16	TO9Y15	WK13	WSD1	ZE34
GYK	LYG6	SV7	TO8RX17	TO9Y16	WK14	WSD1R	ZE34R
GYK6	LYH	TN16X	TO8RX18	TO9Y17	WK15	YA1	ZE34RX
GYP5A	LYH6	TO1	TO8RX2	TO9Y18	WK16	YA27R	ZE34X
GYP5B	LYK	TO108X	TO8RX3	TO9Y2	WK17R	YA31	ZE39
GYP5D	LYK6	TO15	TO8RX4	TO9Y3	WK18	YA5	ZE39R
GYP6A	LYP5A	TO16	TO8RX5	TO9Y4	WK19	YA67	ZE39RX
GYP6B	LYP5B	TO17	TO8RX6	TO9Y5	WK1X	YA70	ZE39X
GYP6D	LYP5D	TO1X	TO8RX7	TO9Y6	WK2	YA70R	ZE40X
HT2	LYP6A	TO2	TO8RX8	TO9Y7	WK20	YA71	
IE6X	LYP6B	TO25R	TO8RX9	TO9Y8	WK21	YA71R	
JOW1	LYP6D	TO28R	TO8X1	TO9Y9	WK22	YA72	
JOW12RX	MEG2	TO29X	TO8X10	TOP1RX	WK25	YA72R	
JOW12X	MIL1	TO3	TO8X11	TR15	WK25R	YA84	
JOW1R	NME3	TO30	TO8X12	TU2	WK26	YA84R	





Q								
	AB1	DM12-24	DM12-9	DM42	DM65-21	DM65R-00	DM76	DM91
	AB1R	DM12-25	DM12R-00	DM42R	DM65-22	DM65R-12	DM76R	DM91R
	BK1	DM12-26	DM12R-12	DM43	DM65-23	DM65R-13	DM77	DM92
	CE2	DM12-27	DM12R-13	DM43R	DM65-24	DM65R-16	DM77R	DM92R
	CS206	DM12-28	DM12R-16	DM44	DM65-25	DM65R-19	DM78	DM93
	DM103	DM12-29	DM12R-19	DM44R	DM65-26	DM65R-31	DM78R	DM93R
	DM108	DM12-3	DM12R-31	DM45	DM65-27	DM65R-32	DM79	DM94
	DM108R	DM12-30	DM12R-32	DM45R	DM65-28	DM65R-34	DM79R	DM94R
	DM109	DM12-31	DM12R-34	DM46	DM65-29	DM65R-35	DM80	DM95
	DM109R	DM12-32	DM12R-35	DM46R	DM65-3	DM65R-36	DM80R	DM95R
	DM115	DM12-33	DM12R-36	DM47	DM65-30	DM66	DM81	DM97R
	DM115R	DM12-34	DM132	DM47R	DM65-31	DM66R	DM81R	LEA1
	DM119	DM12-35	DM132R	DM50	DM65-32	DM67	DM82	TE2
	DM12-00	DM12-36	DM14	DM50R	DM65-33	DM67R	DM82R	TO1
	DM12-1	DM12-37	DM141R	DM60	DM65-34	DM68	DM83	TOP1R
	DM12-10	DM12-38	DM150	DM60R	DM65-35	DM68R	DM83R	UL050
	DM12-11	DM12-39	DM151R	DM65-00	DM65-36	DM69	DM84	UL051
	DM12-12	DM12-4	DM152	DM65-1	DM65-4	DM69R	DM84R	VAC2
	DM12-13	DM12-40	DM154	DM65-10	DM65-40	DM70	DM85	VI15R
	DM12-14	DM12-41	DM154R	DM65-11	DM65-41	DM70R	DM85R	VI16R
	DM12-15	DM12-42	DM18	DM65-12	DM65-42	DM71	DM86	WK1
	DM12-16	DM12-43	DM18R	DM65-13	DM65-43	DM71R	DM86R	YA1
	DM12-17	DM12-44	DM20	DM65-14	DM65-44	DM72	DM87	ZE1
	DM12-18	DM12-45	DM26	DM65-15	DM65-45	DM72R	DM87R	ZE1R
	DM12-19	DM12-46	DM26R	DM65-16	DM65-46	DM73	DM88	
	DM12-2	DM12-47	DM29	DM65-17	DM65-5	DM73R	DM88R	
	DM12-20	DM12-5	DM29R	DM65-18	DM65-6	DM74	DM89	
	DM12-21	DM12-6	DM33R	DM65-19	DM65-7	DM74R	DM89R	
DM12-22	DM12-7	DM40	DM65-2	DM65-8	DM75	DM90		
DM12-23	DM12-8	DM40R	DM65-20	DM65-9	DM75R	DM90R		

Y								
	EL1	UL051	YA31	YA44	YA49	YA54	YA59	YA63
	JH1	UL054	YA31R	YA45	YA50	YA55	YA6	YA6R
	PC11	VAL1	YA41	YA46	YA51	YA56	YA60	
	PC11R	YA226	YA42	YA47	YA52	YA57	YA61	
	UL050	YA227	YA43	YA48	YA53	YA58	YA62	



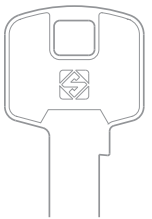
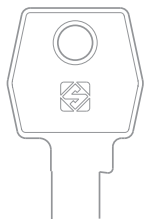
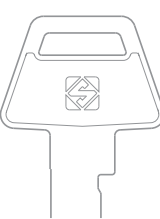

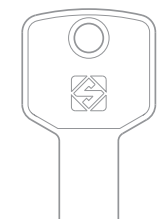
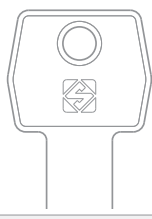
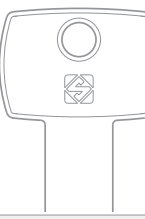
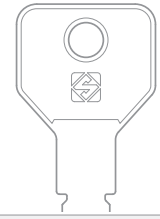
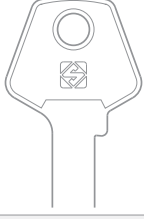
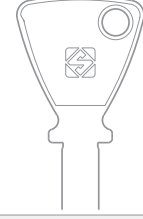





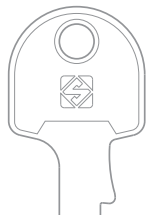

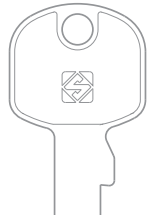
<p><b>A</b></p> 	<p><b>L</b></p> 	<p><b>N</b></p> 	<p><b>22</b></p> 	<p><b>29</b></p> 	<p><b>31</b></p> 
<p>CB6 CB7 CB8 CB9 CB10 CB11 CB12 CB13 CB14 CB15 CB16 CB17 CS204 CS206 FM090 FM1 IE6 JM2R MTA1R UL050 UL051 VI080 VI082 WA1R WA2R</p>	<p>UL050 UL050SL UL051SL UL052SL UL053SL UL054SL UL055SL UL058SL YT15L YT16L</p>	<p>CB85 CC1 CS7 IE3 UL058 VI084 VI086</p>	<p>SM1</p>	<p>OC074</p>	<p>PF2 PF092 PF092S</p>
	<p><b>OV</b></p> 	<p><b>Y</b></p> 	<p><b>168</b></p> 	<p><b>182</b></p> 	<p><b>369</b></p> 
	<p>RU1 VAC151</p>	<p>YA226 YA31 YA6</p>	<p>UNI3</p>	<p>YA1</p>	<p>TE2</p>

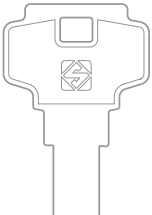
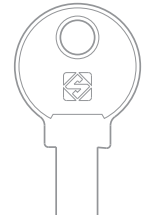

<b>423</b>  MER8	<b>599</b>  AGB1R	<b>754</b>  RU14	<b>1130</b>  IE15	<b>1182</b>  BD9R	<b>1219</b>  CS62 CS115
<b>1275</b>  AGB5 AGB8	<b>1434</b>  CB97	<b>1456</b>  CS146	<b>1557</b>  MER1	<b>1604</b>  KE1	<b>1605</b>  KE3
<b>1606</b>  KE9					

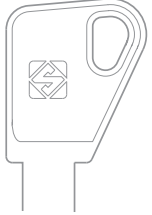

<p><b>OV</b></p> 	<p><b>L</b></p> 	<p><b>A</b></p> 	<p><b>FA</b></p> 	<p><b>1</b></p> 	<p><b>16</b></p> 
<p>AB1X BK1X BK3-3 BK3-4 BK3-7 BK3-8 BK3-12 CB6 CE1 CE2 CE2X DM3 DM3X KF1 LP5 TO1X UL050X WK1X ZE1 ZE1RX ZE1X ZE2</p>	<p>AB1X BE201 BK1X CB6 CE2X DM3X EV69X TO1X TO30RX UL050X UL052 WK1X</p>	<p>AG2R AG3 BE200 BE202 TN2 UL054 VAC29 VI080</p>	<p>BK1</p>	<p>BE200</p>	<p>DX1</p>
			<p><b>54</b></p> 	<p><b>60</b></p> 	<p><b>182</b></p> 
			<p>EV3R EV3X EV10X1 EV69X GE1X GE7RX GE8R</p>	<p>VAC3</p>	<p>CEN1R YA1E</p>
		<p><b>301</b></p> 	<p><b>305</b></p> 	<p><b>438</b></p> 	<p><b>717</b></p> 
		<p>SH3</p>	<p>KA1</p>	<p>LW4</p>	<p>BD6 - BD6R</p>



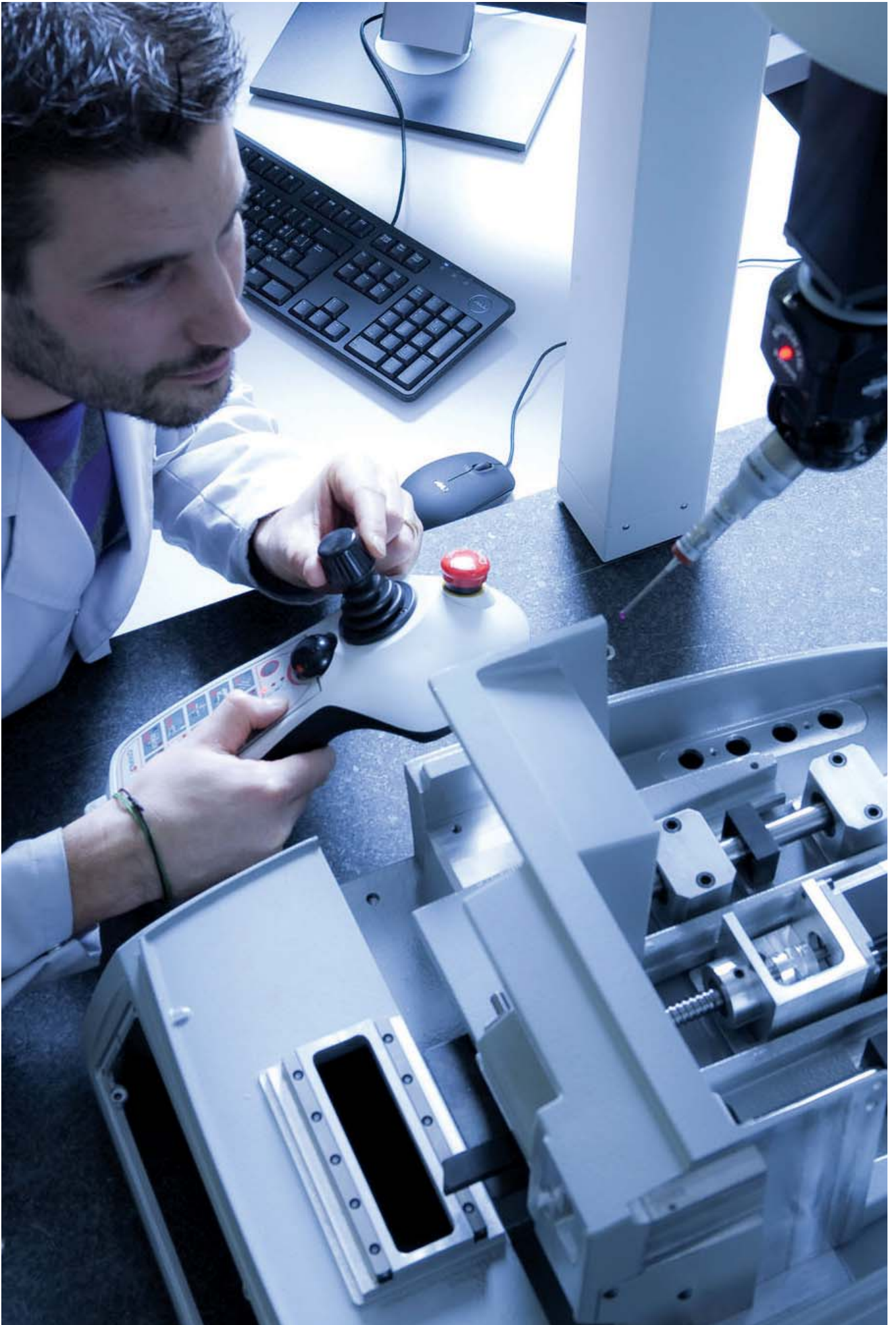





Household keys  
Chiavi piatte  
Flachschlüssel  
Clés plates  
Llaves planas  
Chaves planas



PER:  
FOR:

3F



3

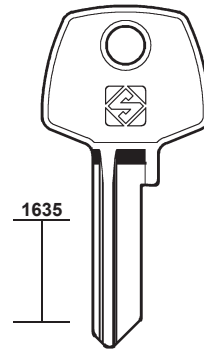
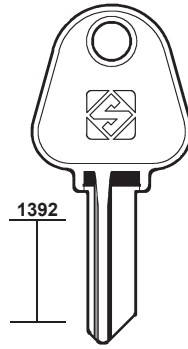
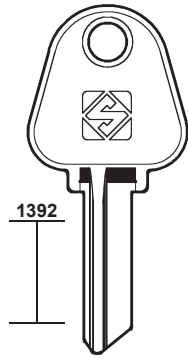
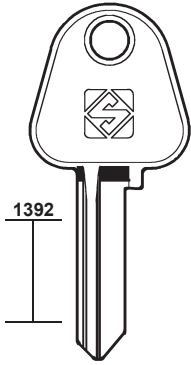

1392

1392

1392

1635

TRF1

TRF1R

TRF2

TRF3

TRF3R

TRF4

PER / FOR

3F (BR)

3M (CN)

333 (IL)  
+ CORNI (62)

555 (TW)  
CINA (54)

606 (AR)

PER:  
FOR:

3F

3M

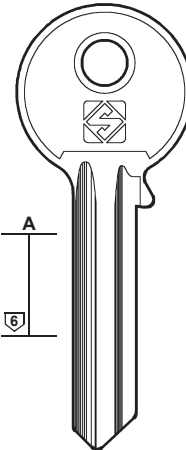
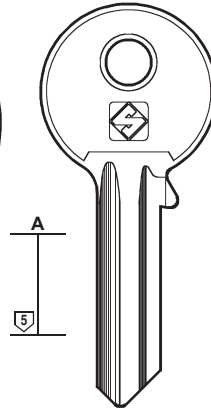
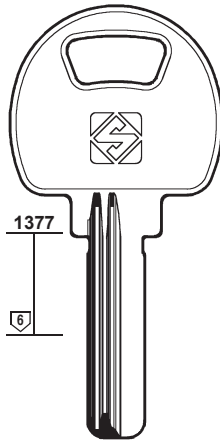
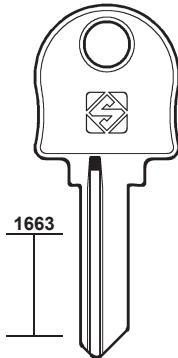
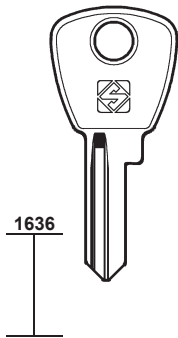

1636

1663

1377

A

A

TRF5R

TRF6R

TRM1R

TRM2

TRM3



PER:  
FOR:

333

606

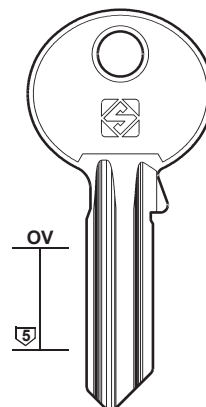
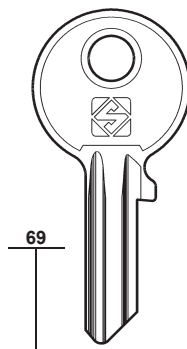
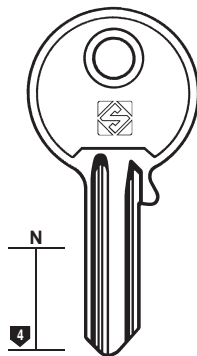
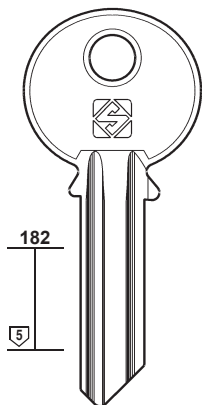

182

N

69

OV

TRE1

TRE2

TRE3

SEI10



4

PER / FOR

aaa (IL)

ABA (GR)

ABBES (GB)  
LAS (122)

ABC (ES)  
BAGEM

ABLOY (FI)  
KITTY  
VIRO

PER: aaa  
FOR:

AAA1

PER: ABA  
FOR:

AAB1

PER: ABC  
FOR:

AC1 AC2

BAGEM

PER: ABLOY  
FOR:

AY1 AY1P AY11

..... (DX)  
..... (SX)  
0-1-2-3-4-5-6-7-8-9

KITTY - VIRO

PER: ABLOY  
FOR:

AY12 AY16 AY30

..... (DX)  
..... (SX)  
0-1-2-3-4-5-6-7-8-9

PER:  
FOR:

# ABLOY



# 5

PER / FOR

ABLOY (FI)

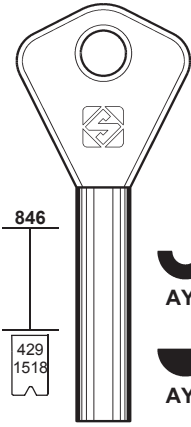

AY14  
AY3  
AY2

C  
..... (DX)  
..... (SX)  
0-1-2-3-4-5-6-7-8-9

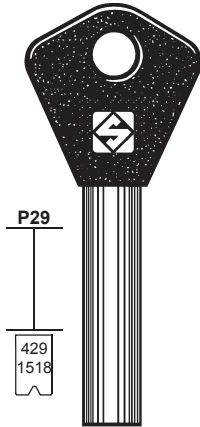

AY2P  
AY3P

..... (DX)  
..... (SX)  
0-1-2-3-4-5-6-7-8-9

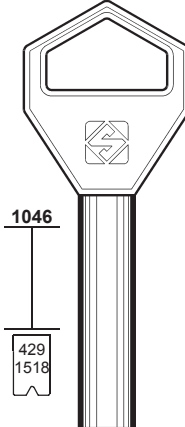

AY13

..... DX  
..... (DX)  
..... (SX)  
0-1-2-3-4-5-6-7-8-9

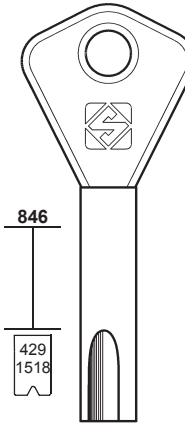

AY15  
AAC



PER:  
FOR:

# ABLOY

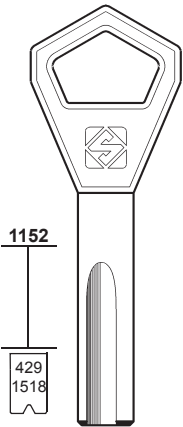

AY17  
ACL

..... DX  
..... (DX)  
..... (SX)  
0-1-2-3-4-5-6-7-8-9

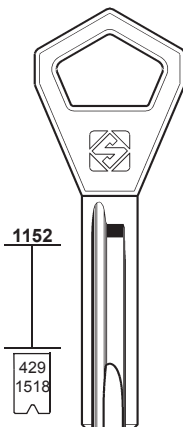

AY18  
NAB

..... DX  
..... (DX)  
..... (SX)  
0-1-2-3-4-5-6-7-8-9

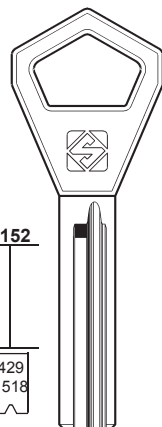

AY20  
TAJ

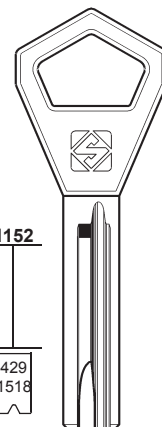

AY21  
TAB

..... DX  
..... (DX)  
..... (SX)  
0-1-2-3-4-5-6-7-8-9

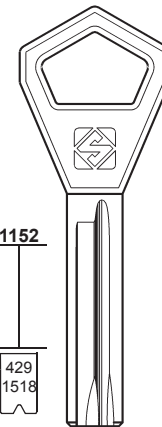

AY23  
RAB



PER:  
FOR:

# ABLOY

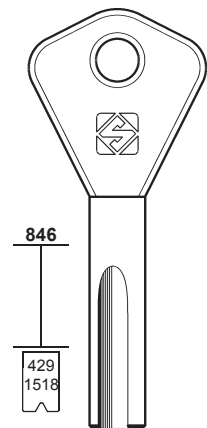

AY24  
ACL

..... DX  
..... (DX)  
..... (SX)  
0-1-2-3-4-5-6-7-8-9

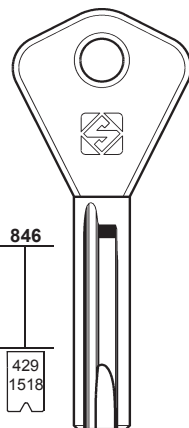

AY25  
NAB

..... DX  
..... (DX)  
..... (SX)  
0-1-2-3-4-5-6-7-8-9

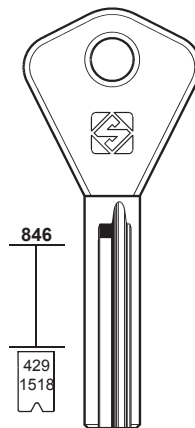

AY26  
TAJ

..... DX  
..... (DX)  
..... (SX)  
0-1-2-3-4-5-6-7-8-9

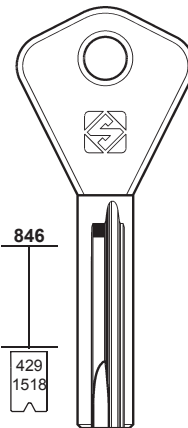

AY27  
TAB



6

PER / FOR

ABLOY (FI)

ABT (IT)

VIRO (206)

ABUS (DE)

CISA  
JPM  
OTHMER  
TOP

+ BRICARD (39)

+ CISA (55-56-57-58)

+ G.R. (99)

+ GUARD (100)

+ PFAFFENHAIN (155)

+ YALE (213)

PER:  
FOR:

### ABLOY

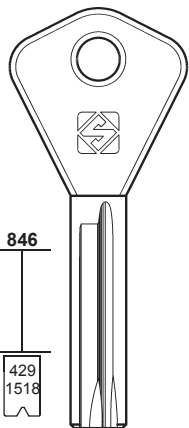

AY28  
RAB

..... DX  
..... (DX)  
..... (SX)  
0-1-2-3-4-5-6-7-8-9

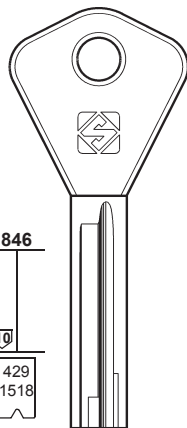

AY29  
RAG

..... (DX)  
..... (SX)  
0-1-2-3-4-5-6-7-8-9

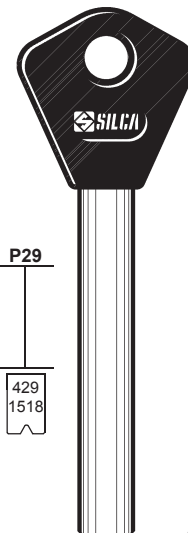

AY10P



PER:  
FOR:

### ABUS

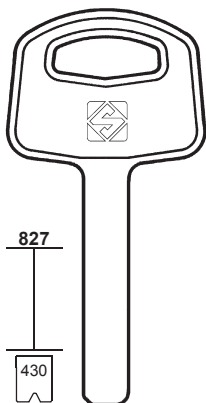

AB32

1-2-3-4-5-6

GRANIT

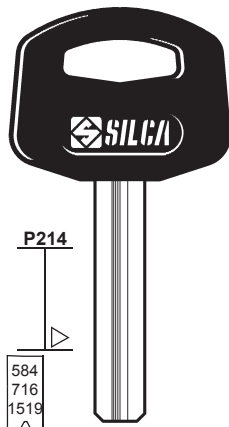

AB38P

1-2-3-4-5-6

ABUS PLUS

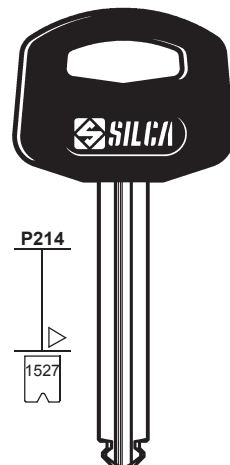

AB60P

1-2-3-4-5-6

PER:  
FOR:

### ABUS

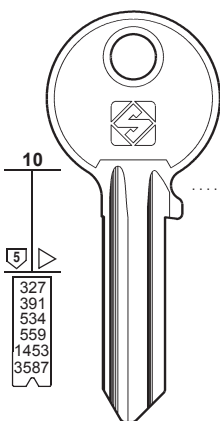

AB1R

1-2-3-4-5-6

AB1

..... 1-2-3-4-5-6

BJ ..... 1-20728

..... 1-2-3-4-5-6-7-8-9

C42 ..... 1-2-3-4-5-6-7-8-9

P ..... 00000-02360

AY ..... 1-6032

BA ..... 1-6032

BB ..... 1-6032

BC ..... 1-6032

BD ..... 1-6032

BK ..... 1-6032

BL ..... 1-6032

BM ..... 1-6032

BN ..... 1-6032

BP ..... 1-6032

BQ ..... 1-6032

BR ..... 1-6032

BS ..... 1-6032

BT ..... 1-6032

BU ..... 1-6032

BY ..... 1-6032

SA ..... 1-6032

SB ..... 1-6032

AB10R

F3  
BC\SS ..... 1-6032  
F2D ..... 1-6032

AB10

F3

AA 000-999

AB 000-999

AF 001-954

AM 001-988

AN 001-958

AV 001-999

BB 001-636

BK 001-997

BL 001-998

BM 002-999

BP 001-331

BQ 001-398

BR 001-397

BT 000-999

BU 000-999

BV 000-999

GF 001-892

GG 001-879

GH 001-359

GJ 001-358

GK 001-308

GM 001-999

BCISS ..... 1-6032

F2C ..... 1-6032

AB8

AB21

AB22

AB78R

AB33

AB26

OTHMER

B09

AB8R

AB21R

AB25R

AB47R

AB34

AB34

B49

AB75

AB104R

AB36

AB37

AB44

AB42R

AB63

AB63

AB67

AB75

AB36R

AB37R

AB44R

AB42R

AB67

JM1

F3

AY-BA

BB-BC

BD-DK

BL-BM

BN-BP

BQ-BR

BS-BT

BU-BY

SA-SB

F3C

..... 1-6032

TOP1R

TOP

JM1R

F3

F3D ..... 1-6032

JM2

JM2R

CISA - JPM - OTHMER - TOP



PER:  
FOR:

# ABUS

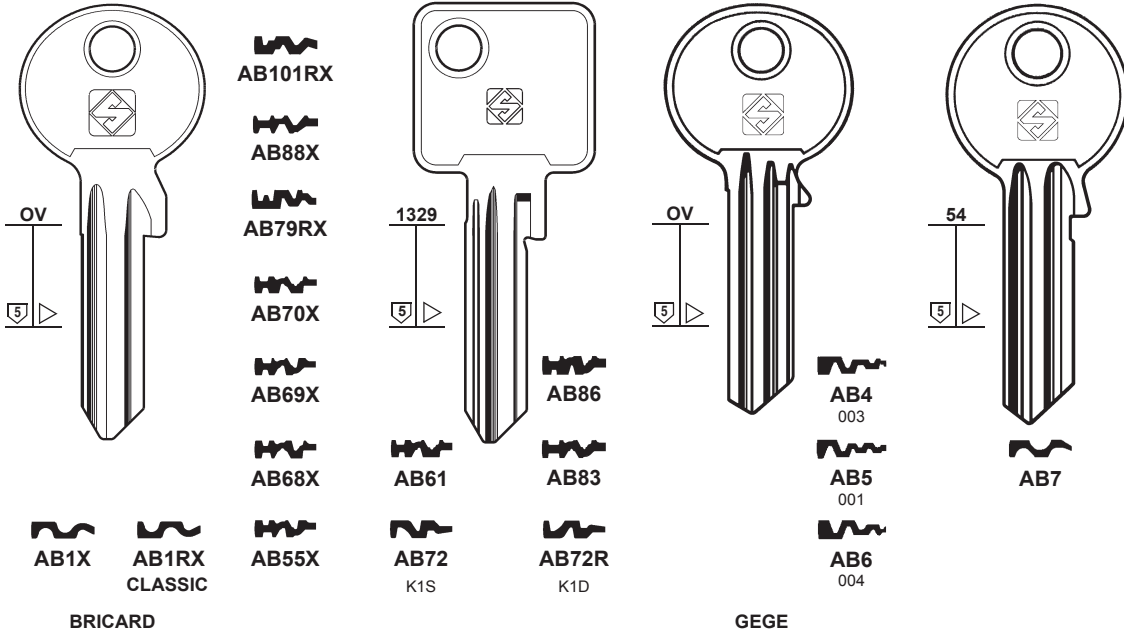

BRICARD

GEGE



# 7

PER / FOR

**ABUS (DE)**

- ANCHOR
- BRICARD
- BUFFO
- CISA
- CLASSIC
- GEGE
- JET
- JPM
- KALE
- + BRICARD (39)
- + CISA (55-56-57-58)
- + G.R. (99)
- + GUARD (100)
- + PFAFFENHAIN (155)
- + YALE (212)

PER:  
FOR:

# ABUS

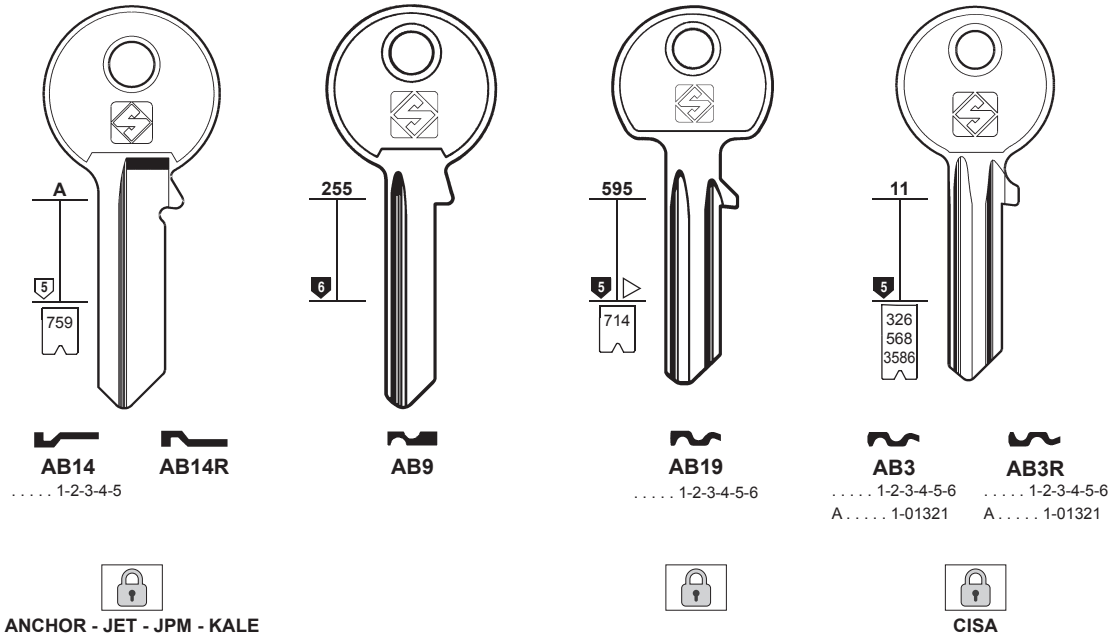

ANCHOR - JET - JPM - KALE

CISA

PER:  
FOR:

# ABUS

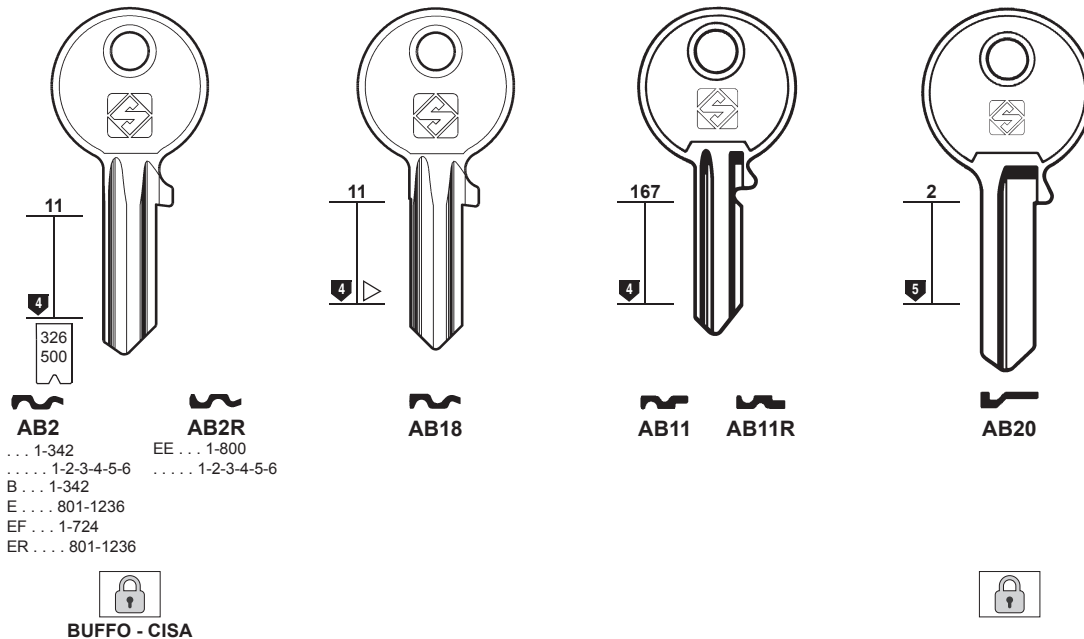

BUFFO - CISA



8

PER / FOR

- ABUS (DE)
- ANCHOR
- ARMSTRONG
- BASI
- BURG
- CISA
- FTH
- GUARD
- GUITTEL
- IMP
- MASTER
- ROYAL
- + BRICARD (39)
- + CISA (55-56-57-58)
- + G.R. (99)
- + GUARD (100)
- + PFAFFENHAIN (155)
- + YALE (213)

PER:  
FOR:

ABUS

Key 1: Dimensions 37, 5. Bit patterns: AB17, AB17R, AB13, AB13R, FTH. Codes: 758, 764, 765, 2709, 2710.

Key 2: Dimensions 37, 5. Bit pattern: AB29R.

Key 3: Dimensions 36, 3. Bit patterns: AB12, AB12R, AB16, AB16R. Codes: 757, 763, 2706, 2707.

Key 4: Dimensions 36, 3, 4. Bit patterns: AB15, AB15R. Codes: 761, 762, 2702, 2703.

Key 5: Dimensions 639, 3. Bit patterns: AB23, AB23R. Codes: 756, 2704.

Icons: ANCHOR - IMP, ANCHOR - BURG, GUITTEL - IMP - ROYAL, CISA, BASI - GUARD.

PER:  
FOR:

ABUS

Key 1: Dimensions 1244, 5. Bit pattern: AB81.

Key 2: Dimensions 806, 5, 327. Bit pattern: AB27. Code: 1-2-3-4-5-6. Icon: mm 50-60.

Key 3: Dimensions 806, 5. Bit patterns: AB30, AB30R.

Key 4: Dimensions 810, 5. Bit pattern: AB31. Icon: lock.

PER:  
FOR:

ABUS

Key 1: Dimensions 132. Bit patterns: AB35, AB35R. Icon: lock.

Key 2: Dimensions 132. Bit patterns: AB39, AB39R. Icon: lock.

Key 3: Dimensions 48. Bit pattern: AB41R. Icon: MASTER.

Key 4: Dimensions 48, 5. Bit patterns: AB43, AB43R. Icon: ARMSTRONG.

Key 5: Dimensions 2, 5. Bit pattern: AB45. Icon: lock.

PER:  
FOR:

# ABUS

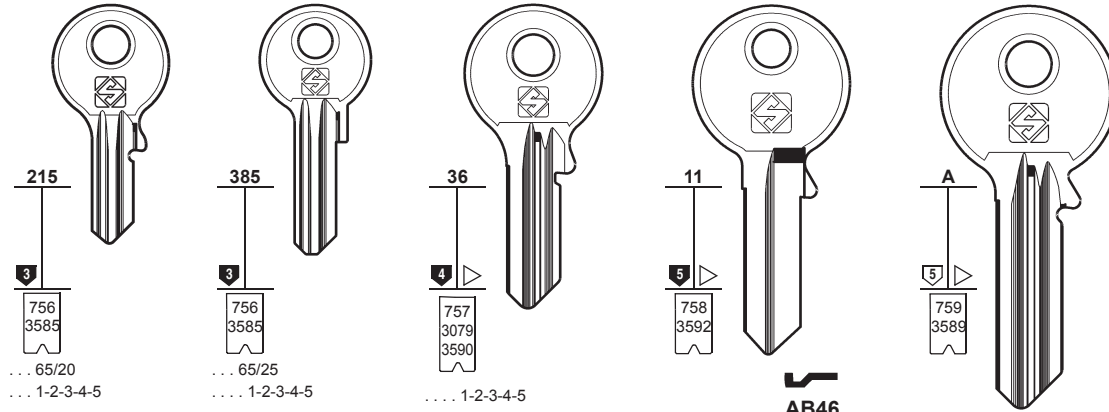

**AB50**

**AB51**

**AB53**

**AB52**  
..... 1-2-3-4-5  
..... 1-2-3-4-5-6

**AB46**  
**AB71**

**AB54**  
..... 1-2-3-4-5



# 9

PER / FOR

- ABUS (DE)**
- BUFFO**
- FORT**
- SECURITAL**
- STEM**
- + BRICARD (39)
- + CISA (55-56-57-58)
- + G.R. (99)
- + GUARD (100)
- + PFAFFENHAIN (155)
- + YALE (213)

PER:  
FOR:

# ABUS

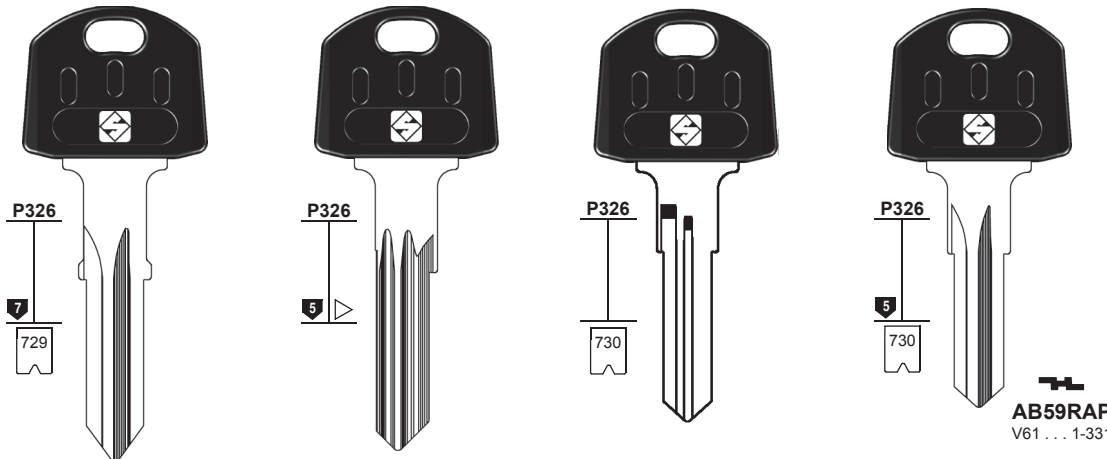

**AB57AP**  
Z71 ..... 1-1043  
Z72 ..... 1-1043

**AB57RAP**  
Z71 ..... 1-1043  
Z72 ..... 1-1043

**AB56AP**  
SL .....  
1-2515

U72  
F82 **AB64RAP**  
V62 ... 1-331  
X61 ... 1-331  
X62 ... 1-331

**AB65RAP** W71

**AB58AP**

**AB58RAP**  
X61 ... 1-331  
X62 ... 1-331  
V62 ... 1-331

**AB59RAP**  
V61 ... 1-331



BUFFO



PER:  
FOR:

# ABUS

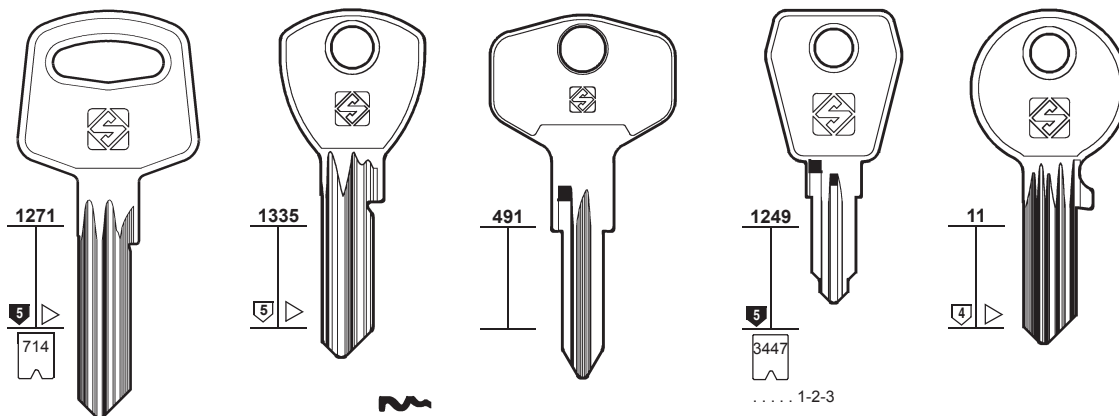

**AB102**

**AB56**  
SR .....  
1-2515

**AB56R**  
SL .....  
1-2515

**AB76** **AB76R**

**AB93R**

**AB90R**  
FG

**AB85**  
AL



FORT - SECURITAL



10

PER / FOR

- ABUS (DE)
- CISA
- BRICARD
- + BRICARD (39)
- + CISA (55-56-57-58)
- + G.R. (99)
- + GUARD (100)
- + PFAFFENHAIN (155)
- + YALE (213)

ACE (US)

- CHICAGO (52)

PER:  
FOR:

ABUS

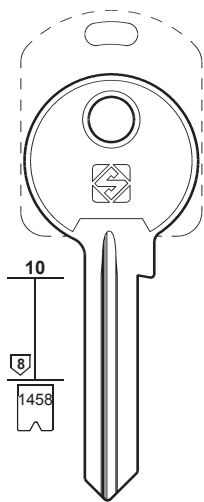

10  
8  
1458

..... 1205-9533  
..... 1717-9020



**AB66R**  
48/49

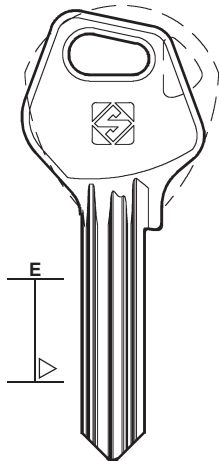

E



**AB91**

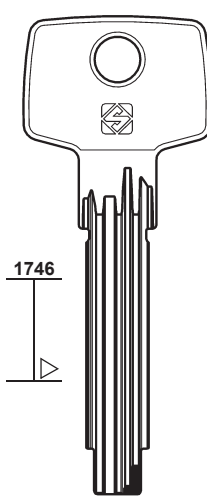

1746



**AB109**

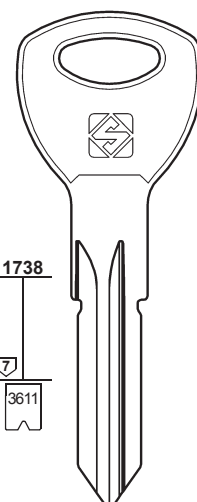

1738  
7  
3611

NW72 ..... 00001-10000  
NW72 ..... 20001-25312



**AB105R**



PER:  
FOR:

ABUS

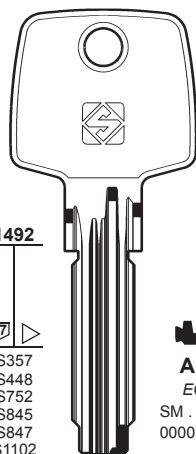

1492  
6+7

S357  
S448  
S752  
S845  
S847  
S1102



**AB74**

..... 00001-38832  
..... 0001-4800  
..... (XN005710)1-38832  
..... 000001-168000



**AB84**  
EC550

SM .....  
00001-30000



**AB77**

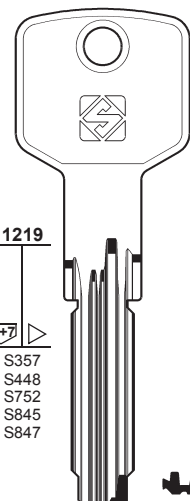

1219  
6+7

S357  
S448  
S752  
S845  
S847



**AB48**

..... 00001-38832  
..... 0001-4800  
..... (XN005710)1-38832  
..... 000001-168000

NEW ASTRAL

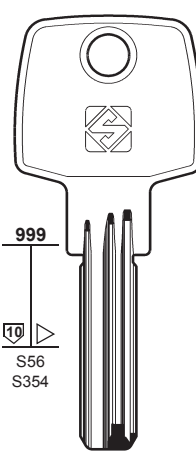

999  
10

S56  
S354



**AB40**

AAL  
EXTRA-CLASSE

- 00001-50252

CISA - BRICARD

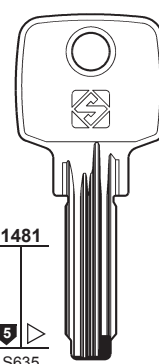

1481  
5

S635  
S846



**AB62**

EC75

..... 00001-10000  
D8 ..... 0001-8000

mm 30-40-50



PER:  
FOR:

ABUS

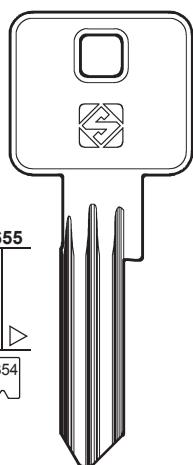

1655  
6  
2354



**AB89**

E60  
..... 00001-30000



**AB95**

E60  
..... 1234567

E20/E30  
..... 00001-30000

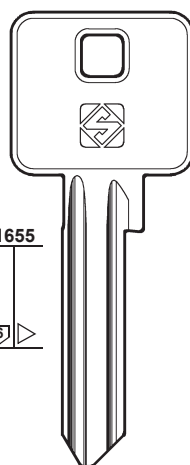

1655  
6



**AB98**

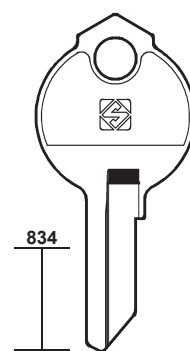

834



**AB100**



**AB100R**

PER: **ADAMS RITE**  
FOR:

**ADS**

**AEP**

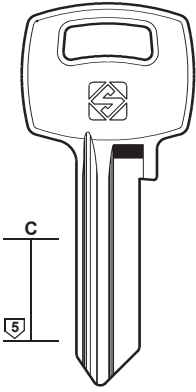

**ADT1**

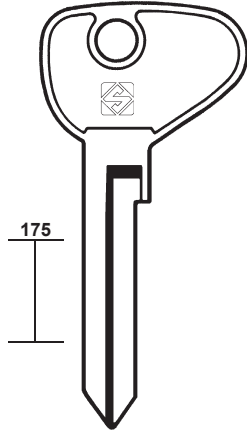

**AD1**

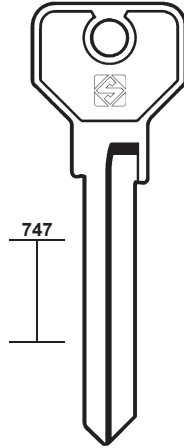

**AD2**

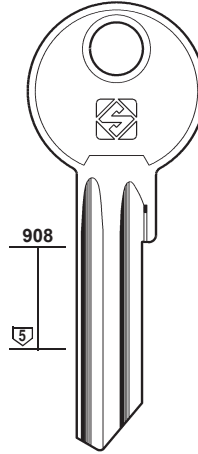

**AEP1**

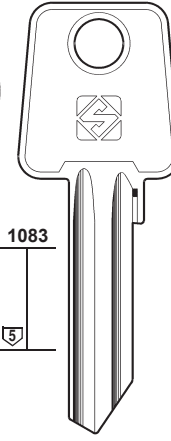

**AEP2**



**11**

PER / FOR

**ADAMS RITE (US)**

**ADEMCO (US)**

**CHICAGO (52)**

**ADS (DE)**

**AEP (LV)**

**AGA (ES)**

**ARREGUI**  
**BTV**  
**CASAS**  
**COLOMENCA**  
**FB**  
**GARI**  
**MECALUX**  
**SERRALLER**  
**SUYOKA**  
**TERCA**

**AGB (IT)**  
**SAVIO**

PER:  
FOR:

**AGA**

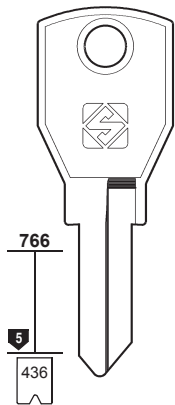

**AGA1**  
B ...  
901-926

**AGA1R**  
A ...  
901-926

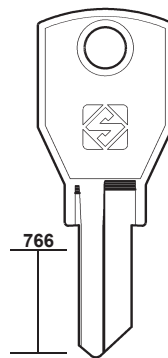

**AGA2**  
D ...  
901-926

**AGA2R**  
C ...  
901-926

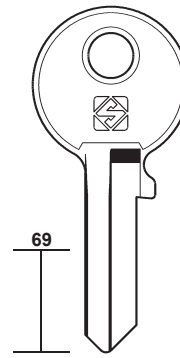

**AGA25**



**AGA4**  
G ... 501-526  
G ... 901-926

**AGA4R**  
H ... 501-526  
H ... 901-926

**AGA5**  
E ... 501-526  
E ... 901-926

**AGA5R**  
F ... 501-526  
F ... 901-926

**AGA3**

**AGA25R**



**BTV - MECALUX - SUYOKA**



**ARREGUI**

PER:  
FOR:

**AGA**

**AGB**

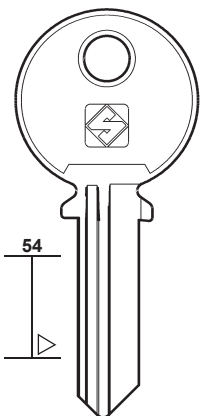

**AGA6**

**GARI**

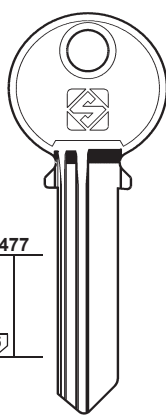

**AGA8**

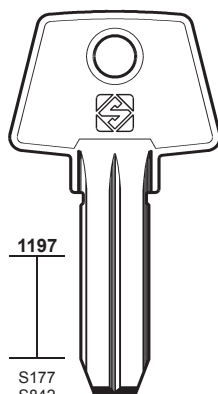

S177  
S842  
S897  
S898  
S971  
S972  
S971  
S1020

**AGA7**

..... 1-2-3-4-5

**COLOMENCA - FB**  
**SERRALLER - TERCA**

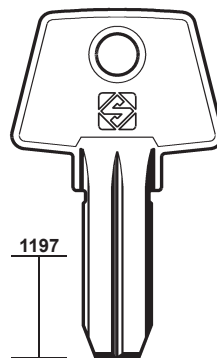

S841  
S895  
S896

**AGA9**

**CASAS**

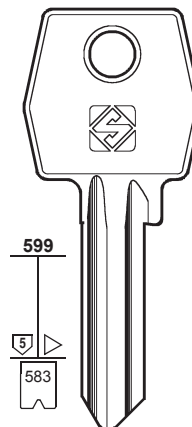

**AGB1**

**SAVIO**

**AGB1R**

.....  
1-2-3-4-5-6-7



12

PER / FOR

AGB (IT)  
SAVIO

AGE (JP)

PER:  
FOR:

AGB

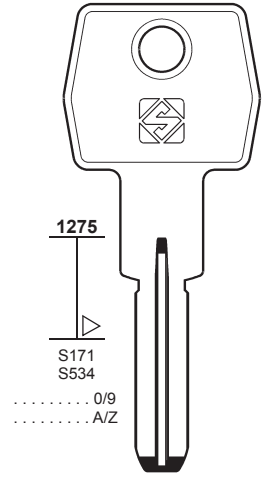
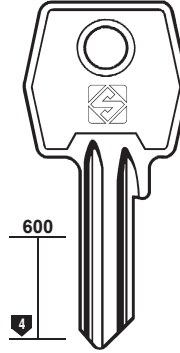
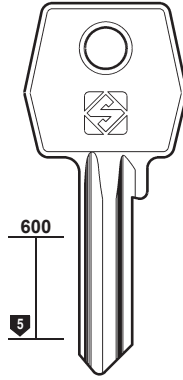
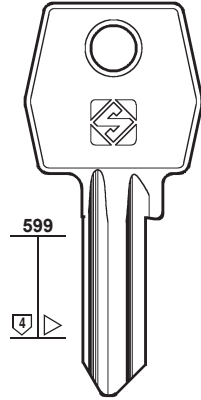

AGB2 AGB2R

SAVIO



AGB3 AGB3R

SAVIO



AGB4 AGB4R



AGB5  
SCUDO 9000



PER:  
FOR:

AGB

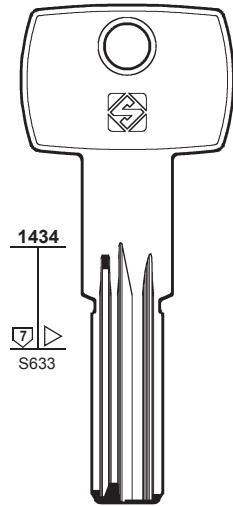

HNH  
AGB8

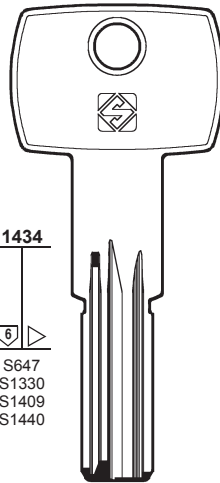

HNH  
AGB9

..... 0/9  
..... A/Z

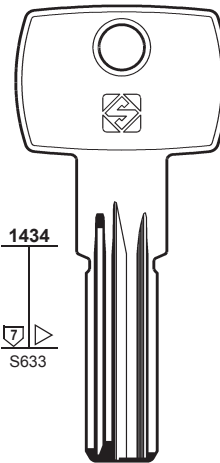

HNH  
AGB6  
SCUDO 7000

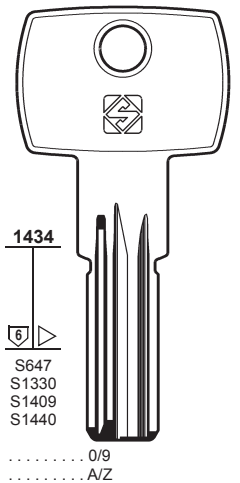

HNH  
AGB7  
SCUDO 5000

SCUDO

PER:  
FOR:

AGE

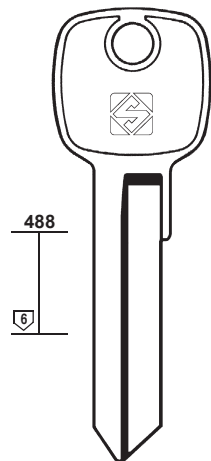

AGE4R AGE5R

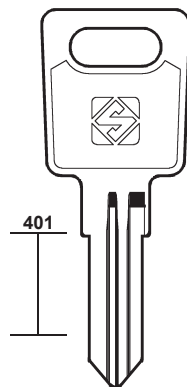

AGE6

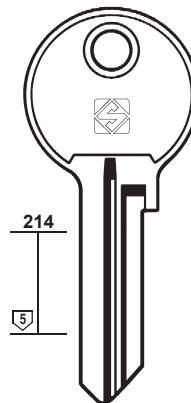

AGE2

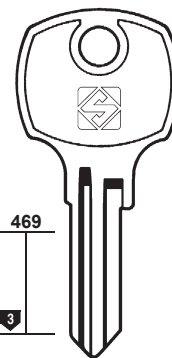

AGE3

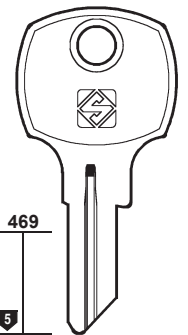

AGE1 AGE1R



PER:  
FOR: **AGENT**

**AGUIA**

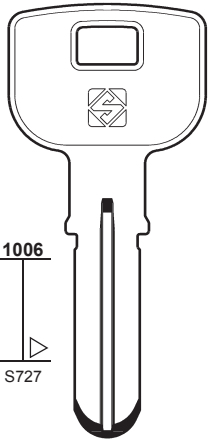

**AGN1**

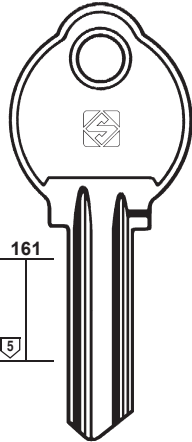

**AG1**

**AG1R**

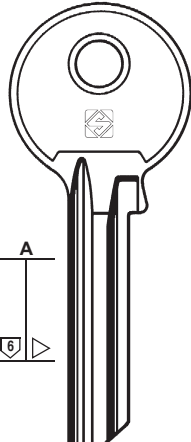

**AG4**

**AG4R**

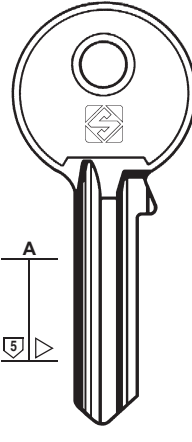

**AG2**

**AG2R**

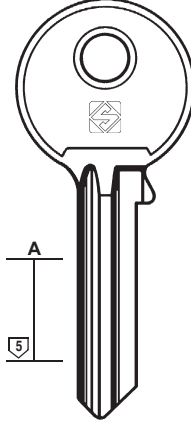

**AG3**

**AG3R**

**AG7**

**AG7R**



**13**

PER / FOR

**AGENT (JP)**

**AGUIA (PT)**

**AISPUTE (LV)  
KURZEMES**

**AKIRA (IT)  
YETI (218-219)**

**AKKA (IT)  
WALLY (207)**

**AL (PT)**

**AL AHRAM (EG)**

PER:  
FOR:

**AGUIA**

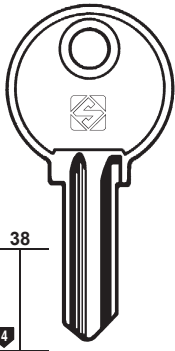

**AG5**

**AG5R**

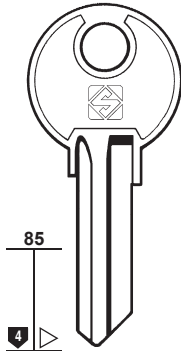

**AG6**

**AG6R**

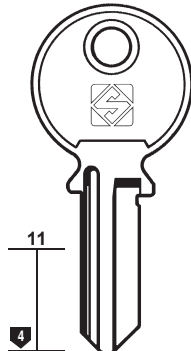

**AG8**

**AG8R**

**AG9**

**AG9R**

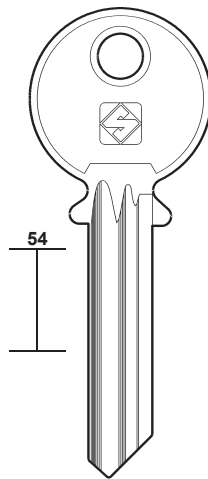

**AG10**

PER:  
FOR:

**AISPUTE**

**AL**

**AL AHRAM**

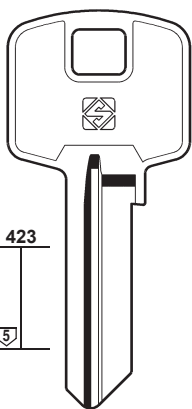

**ASU1R**

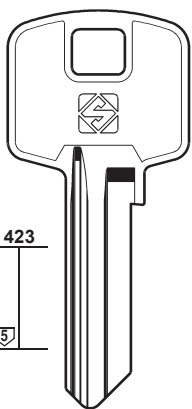

**ASU2**

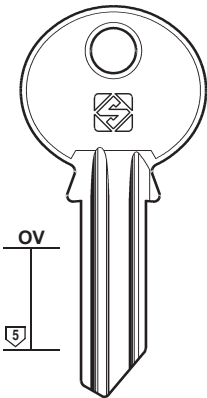

**AL1**

**AL1R**

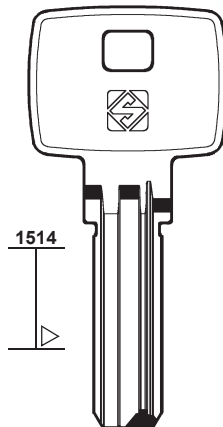

**AHR2**



**KURZEMES**



14

PER / FOR

ALA (IT)  
CISA  
+ CISA (55-57)  
+ KESO (115)

ALDRIDGE E. (GB)  
ASEC SECURITY

PER:  
FOR:

ALA

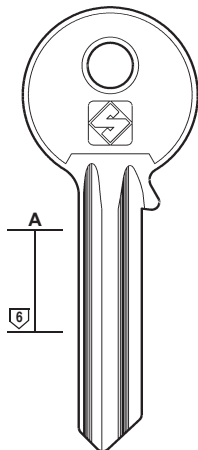

AA6 AA6R

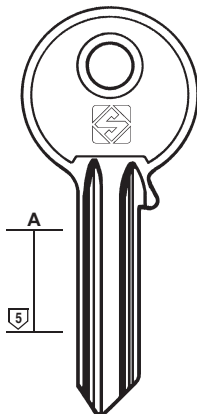

AA5 AA5R

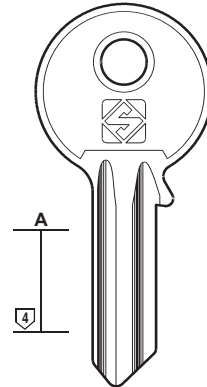

AA1 AA1R



PER:  
FOR:

ALA

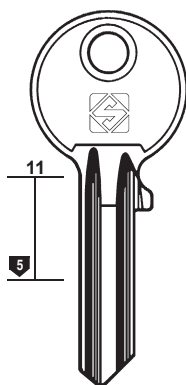

AA2 AA2R

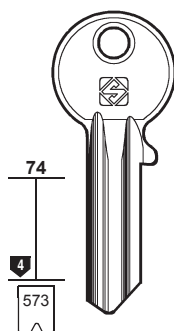

AA3 AA3R  
.....  
1-2-3-4-5-6-7

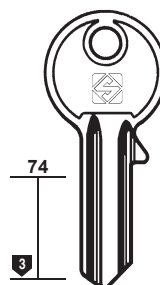

AA4  
AA4R

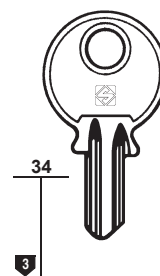

CS12  
CS12R



PER:  
FOR:

ALDRIDGE E.

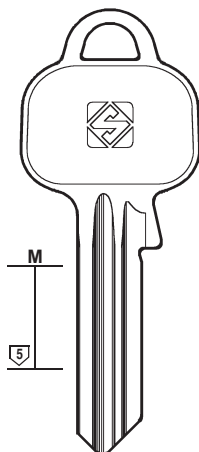

AE1R

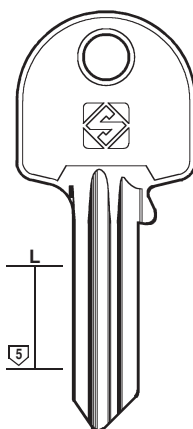

AE2R

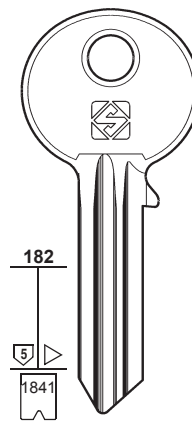

.....  
1-2-3-4-5-6

ASEC1

ASEC SECURITY



PER:  
FOR: **ALDRIDGE E.**

**ALFA**

**ALIANÇA**



**15**

PER / FOR

**ALDRIDGE E.** (GB)  
ASEC SECURITY

**ALF** (FR)  
CISA (55)

**ALFA** (SE)

**ALI** (TW)  
CINA (54)

**ALIANÇA** (BR)

**ALKE** (IT)

**ALLGOOD** (GB)  
CENTURY (46)

**ALMET** (US)  
ARROW (20)

**ALPHA** (IT)  
CHICAGO (52)

PER:  
FOR: **ALKE**

**ALPHA**

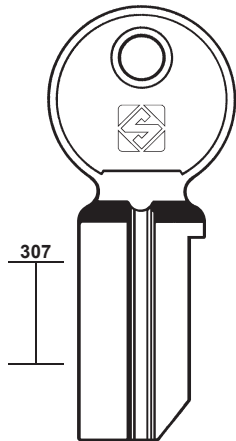

**ALK1**

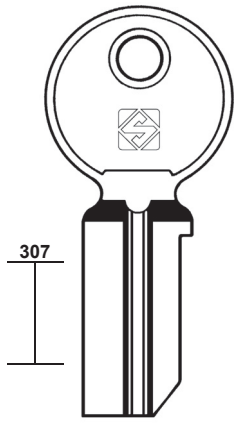

**ALK2**

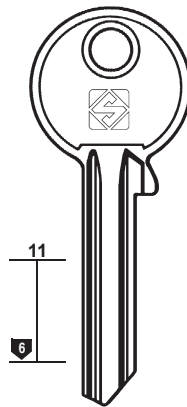

**ALP2**

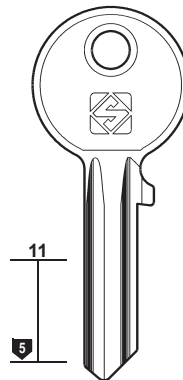

**ALP11**

PER:  
FOR: **ALPHA**

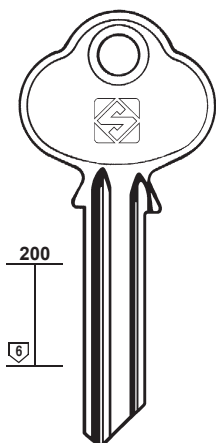

**ALP3**

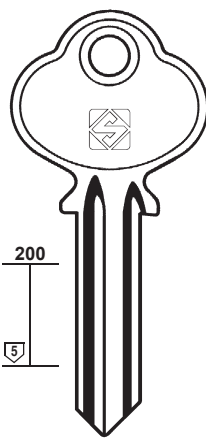

**ALP10**

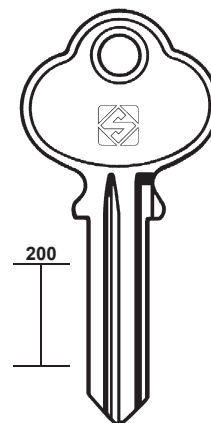

**ALP1**



16

PER / FOR

ALPHA (IT)

FEB  
HMP  
JD  
LINCE  
MONACOR  
SANY  
VISONIC  
+ CHICAGO (51)

ALSO (US)

JUNKUNC (112)  
STS (177)

ALUBOX (IT)

ALUNORM (IT)

CORBIN (60)

AM (IT)

POTENT (156)

AMARO LIMITADA (PT)

PICARDIE

AMELCO (BR)

PER:  
FOR:

ALPHA

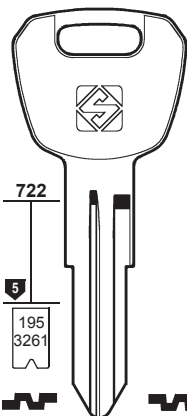

ALP4

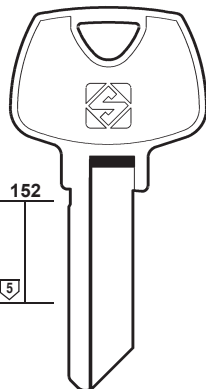

ALP4R

S ... 301-600



ALP9

7000 ...



MONACOR - SANY - VISONIC



ALP9R

LINCE  
JD



ALP6R

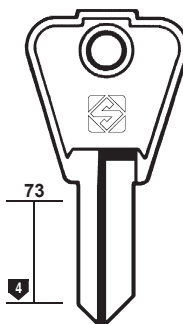

ALP5R



HMP

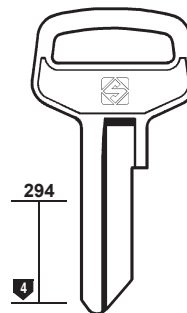

ALP8R



HMP

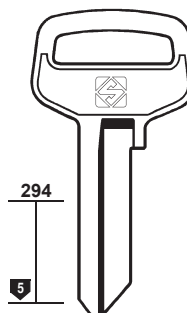

ALP7R



HMP

PER:  
FOR:

ALPHA

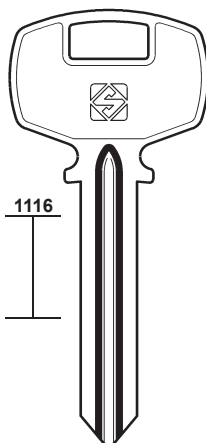

ALP12

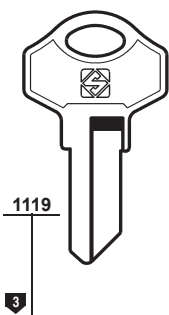

ALP13R

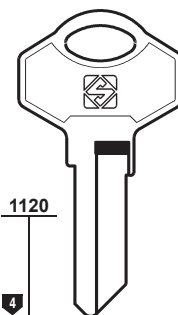

ALP14R

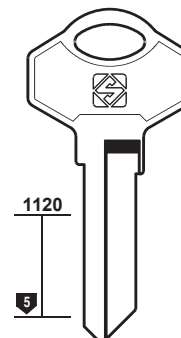

ALP15R

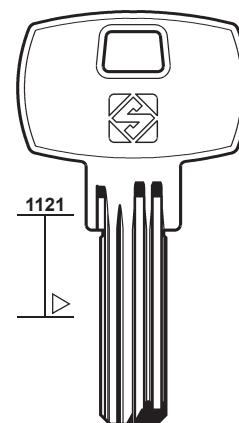

ALP16



PER:  
FOR:

ALUBOX

AMARO LIMITADA

AMELCO

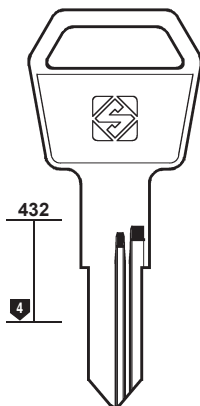

ALU1

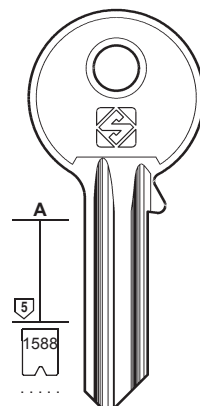

1588

6-5-4-3-2-1



ALM1



ALM1R

PICARDIE

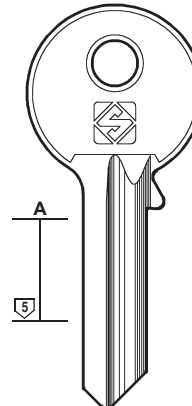

AMC2R

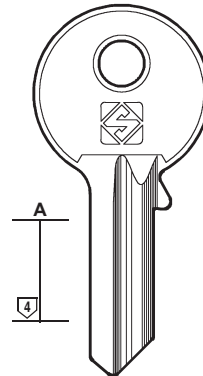

AMC1R

PER:  
FOR: **AMELCO**

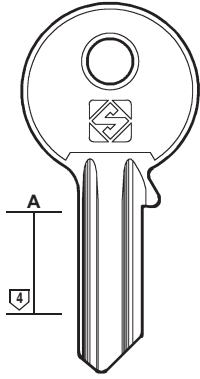

**AMC3**

**AMIG**

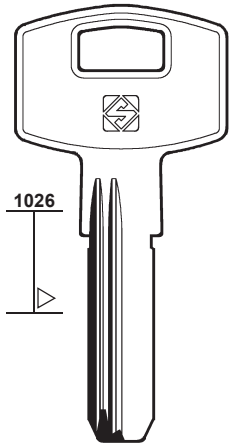

**AMG3R**

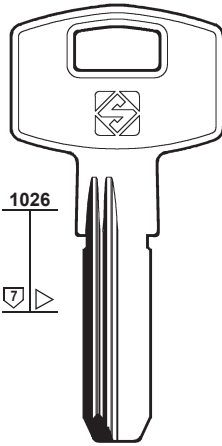

**AMG1R**

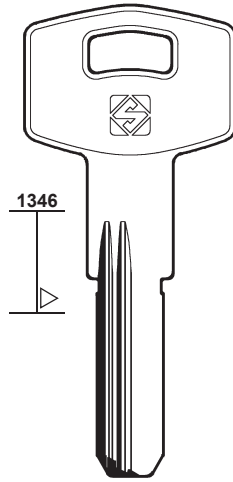

**AMG2R**



**17**

PER / FOR

**AMELCO (BR)**

**AMERICAN (US)**  
**JUNKUNC (112)**

**AMEROCK (US)**  
**ARROW (20)**

**AMIG (ES)**

**ANCHOR (SE)**  
**ANKERSLOT**  
 + **ABUS (7-8)**  
 + **ANKERSLOT (17)**

**ANHSIN (HK)**

**ANKERSLOT (NL)**  
**ANCHOR**  
**LITTO**  
**ODA**  
 + **ANCHOR (17)**  
 + **LITTO (125)**

PER:  
FOR:

**ANCHOR**

**ANHSIN**

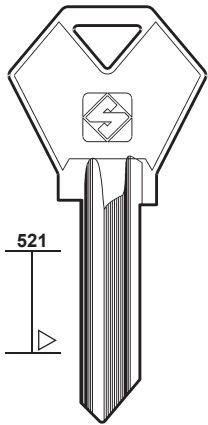

**ACR1**

**ANKERSLOT**

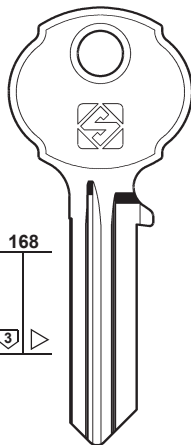

**ACR2**

**ANKERSLOT**

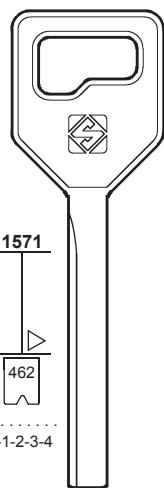

**ACR3**

0-1-2-3-4

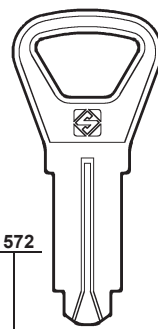

**ACR4**

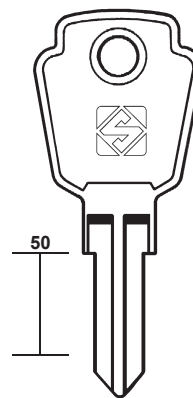

**AH1**

PER:  
FOR:

**ANKERSLOT**

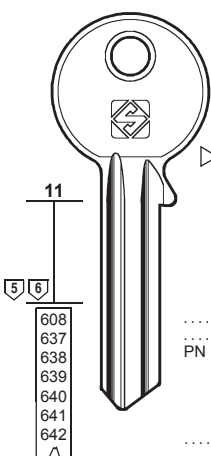

**AKR6**

**AKR3**

A ..... 1-2-3-4-5-6-7  
 ..... 1-2-3-4-5-6-7  
 PN ..... 0/9 1-2-3-4-5-6-7

**AKR3R**

..... 1-2-3-4-5-6-7  
 ..... 1-2-3-4-5-6-7  
 ... L ... 1234567RSTUVWX



**ODA**

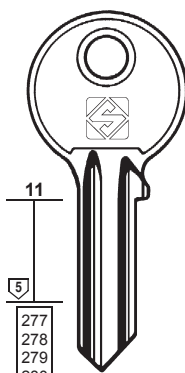

**AKR2**

277  
278  
279  
280  
533  
766

E ..... A .....  
 F ..... B .....  
 K ..... C .....  
 G ..... V .....  
 1-2-3-4-5-6-7 1-2-3-4-5-6-7



**LITTO**

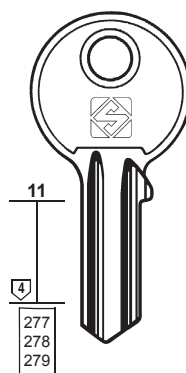

**AKR1**

277  
278  
279

..... 1011-7077  
 B ..... 1-2-3-4-5-6-7  
 E ..... 1-2-3-4-5-6-7  
 F ..... 1-2-3-4-5-6-7  
 K ..... 1011-7077  
 V ..... 1-2-3-4-5-6-7  
 K ... 111-888



**ANCHOR - LITTO - ODA**

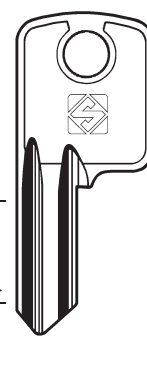

**AKR7**

277  
278

..... 1011-7077  
 B ..... 1-2-3-4-5-6-7  
 E ..... 1-2-3-4-5-6-7  
 F ..... 1-2-3-4-5-6-7  
 K ..... 1011-7077  
 K ... 111-888





18

PER / FOR

ANKERSLOT (NL)  
+ ANCHOR (17)  
+ LITTO (125)

ANLO (FR)  
+ GLOBE (97)

ANTAR (FR)  
VEGA  
+ RONIS (161)

APEKS (RU)

PER:  
FOR:

### ANKERSLOT

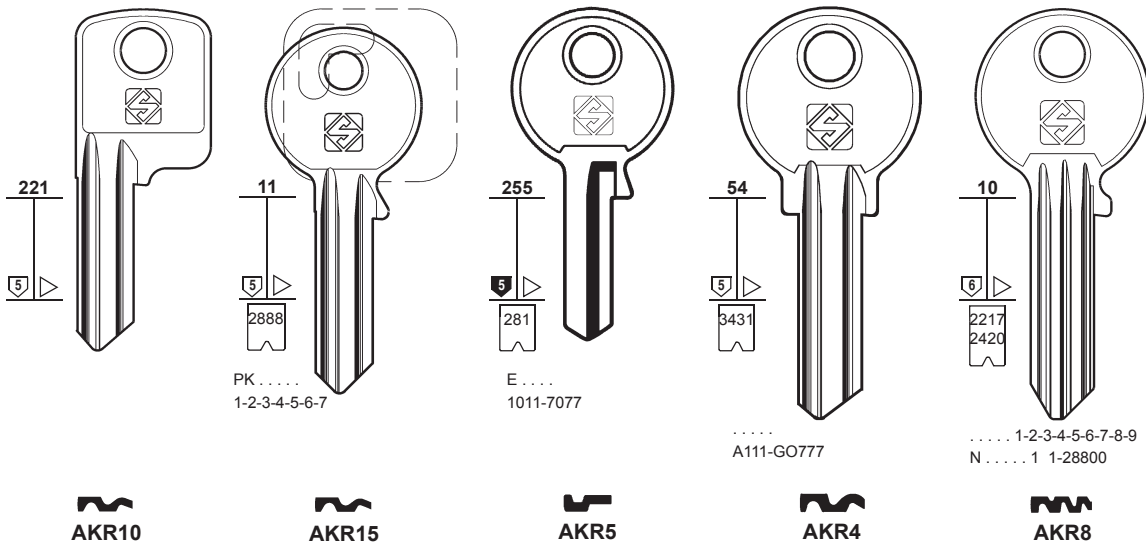

PER:  
FOR:

### ANKERSLOT

### ANTAR

### APEKS

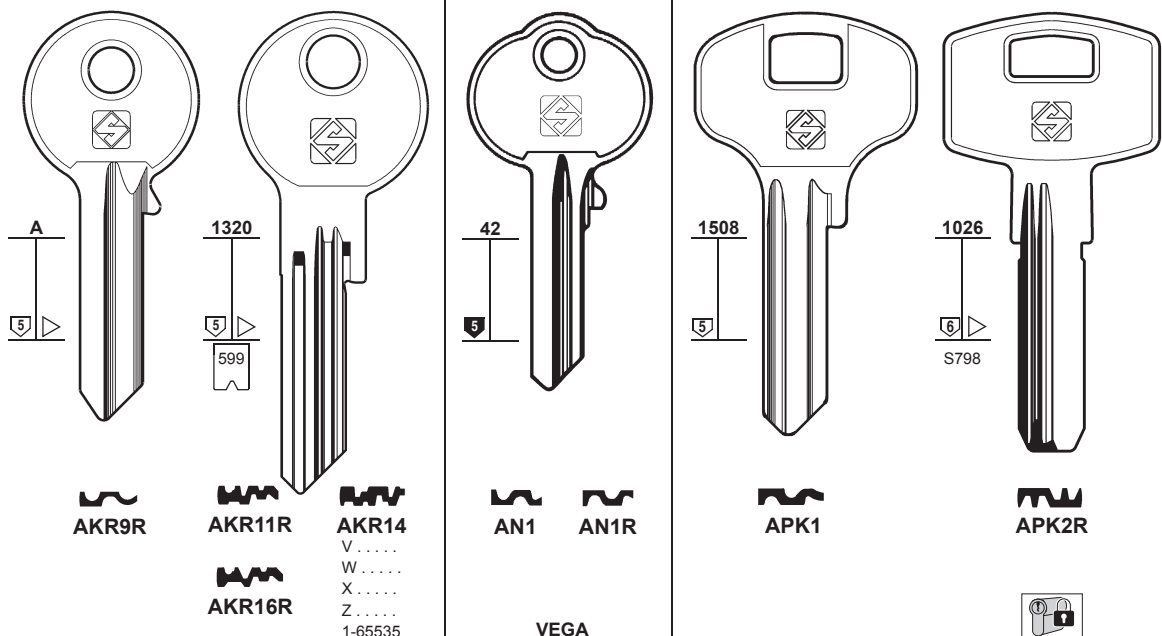

PER:  
FOR:

### APEKS

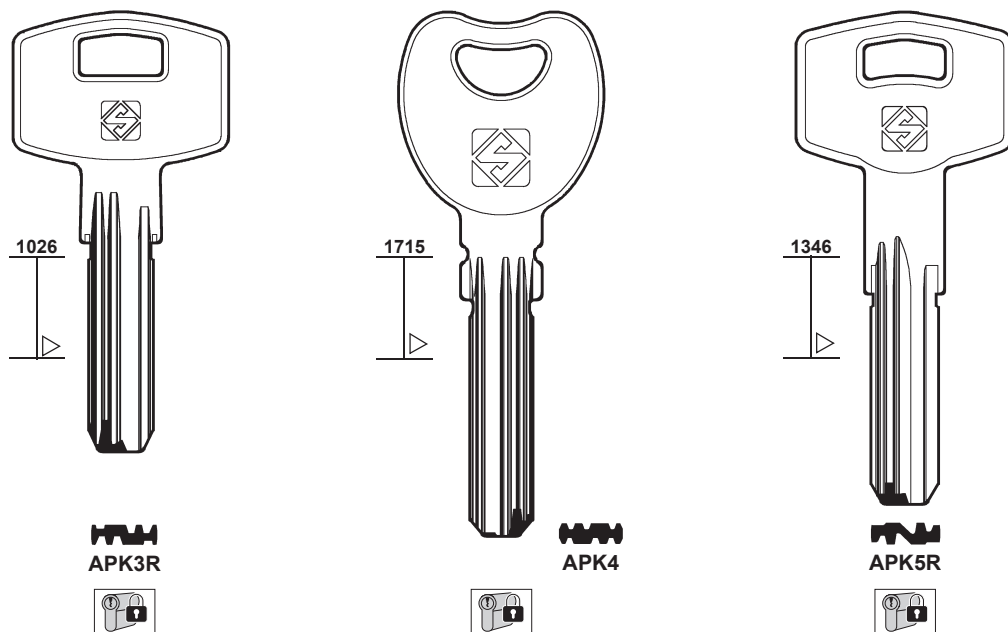

PER:  
FOR:

### AQUILA

### AREL (GB)

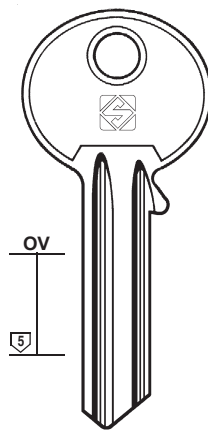
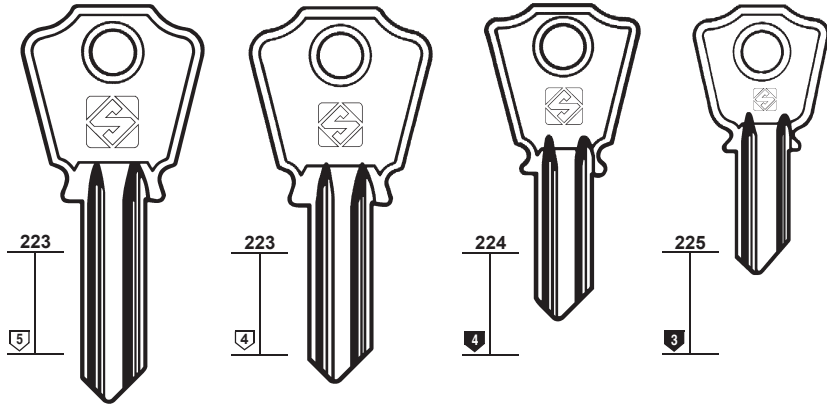

# 19

PER / FOR

**AQUILA** (IT)

**AREL** (GB) (IR)

**ARFE** (ES)

STS

+ FORT (90)

+ STS (177)

**ARMOR** (FR)

+ RONIS (161)

**ARMSTRONG** (CZ)

+ ABUS (8)

**ARNOV** (FR)

+ ZENITH (222)

**AROUCA** (BR)

**ARREGUI** (ES)

+ AGA (11)

+ FAC (84)

PER:  
FOR:

### AREL (I)

### ARFE

### ARMSTRONG

### AROUCA

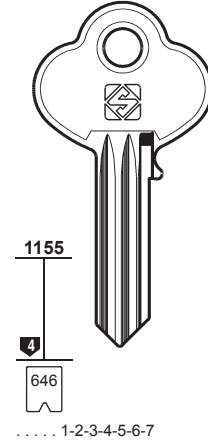
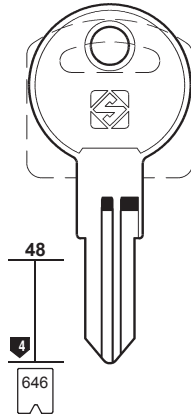
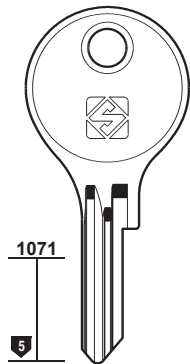
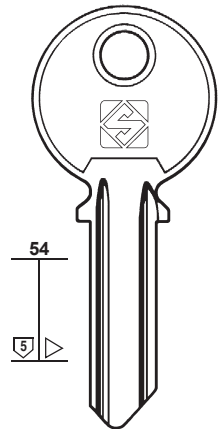

STS

PER:  
FOR:

### AROUCA

### ARREGUI

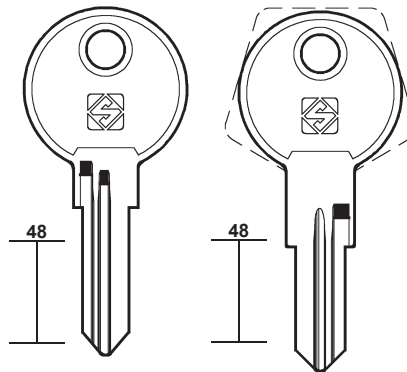
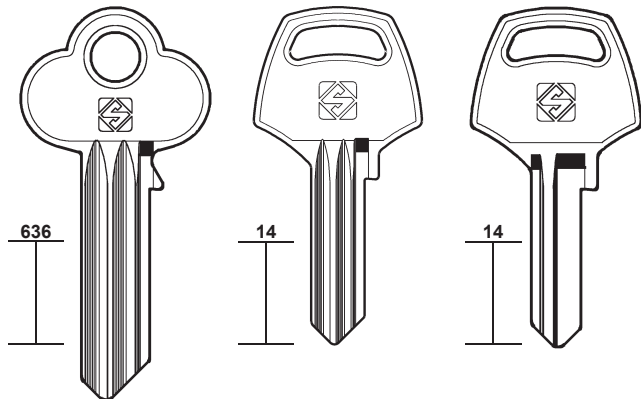



20

PER / FOR

ARROW (US)  
ALMET  
AMEROCK  
DOMINION  
FORT  
LG

ARSENJEVSK (RU)

ASEC SECURITY (GB)  
ALDRIDGE E. (14-15)

ASIA (TW)  
TWRHONB  
+ YETI (218-219)

ASIAN (TW)

ASPA (NL)  
+ DOM (70-71)

PER:  
FOR:

### ARROW

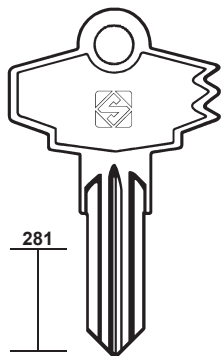

AW1



AW3



AW2



AW4



DOMINION - FORT - LG

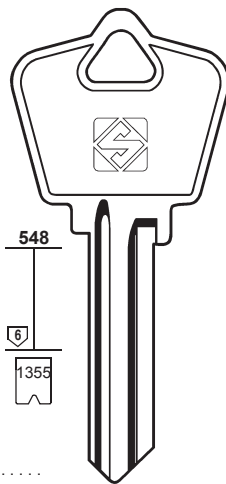

0-1-2-3-4-5-6-7-8-9



AW5  
K7

AMEROCK

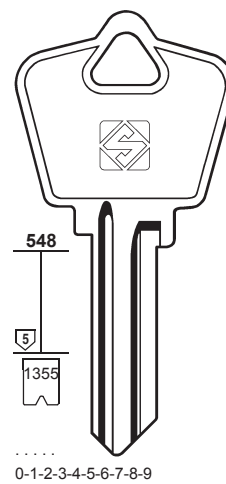

0-1-2-3-4-5-6-7-8-9



AW6  
K7-5

ALMET

PER:  
FOR:

### ARROW

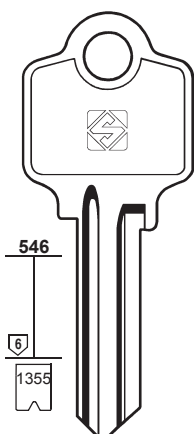

0-1-2-3-4-5-6-7-8-9



AW7  
K2

ALMET

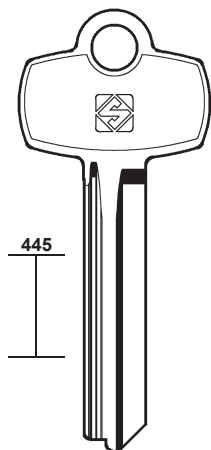

AW22  
1D



AW23  
1C

### ARSENJEVSK

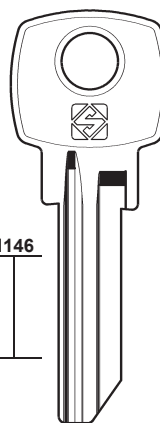

ARS1

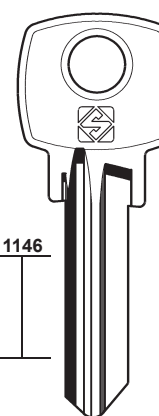

ARS2

PER:  
FOR:

### ASIA

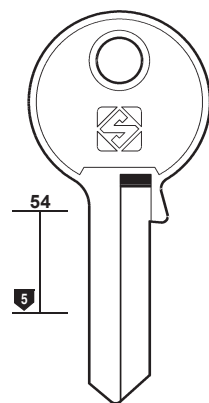

AS1



mm 45  
TWRHONB

### ASIAN

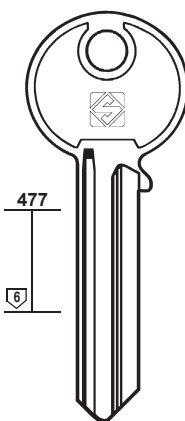

ASN1



### ASPA

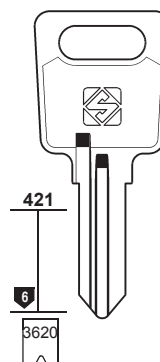

APA1R  
2U ... 1-748

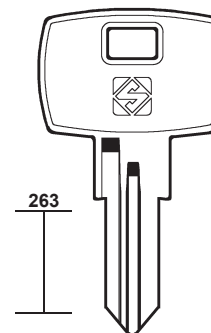

APA2R

PER:  
FOR:

# ASSA



# 21

PER / FOR

**ASSA** (SE)  
TEKA  
+ RUKO (162)  
+ TEKA (181)

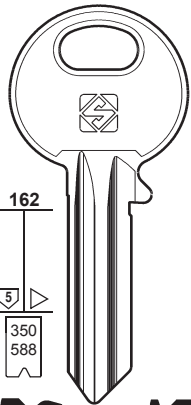

**ASS63**  
22001

**ASS6**  
20201

..... 0-1-2-3-4-5-6-7-8-9-A-B-C  
..... D-0-1-2-3-4-5-6-7-8-9-A-B-C

TEKA

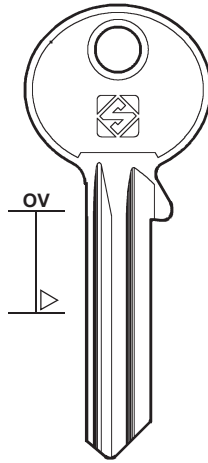

**ASS63R**

**ASS6R**  
20301

**ASS186**

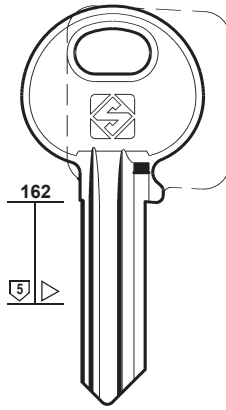

**ASS137**  
22401

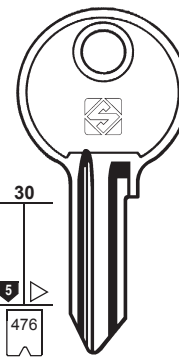

... 151-200  
..... 0-1-2-3-4-5-6

**ASS47**  
21202

PER:  
FOR:

# ASSA

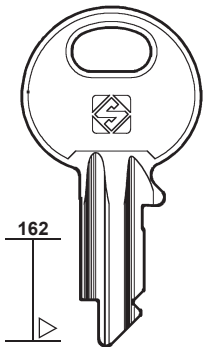

**ASS181**

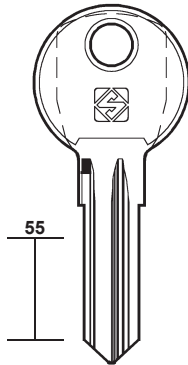

**ASS187R**

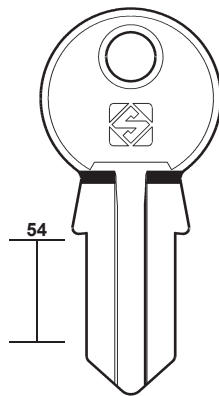

**ASS149**

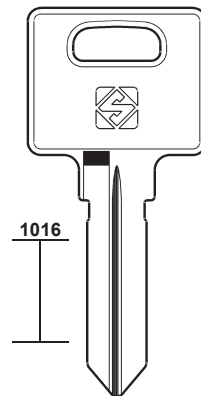

**ASS148**

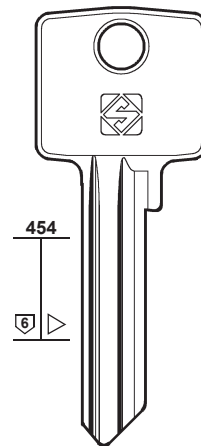

**ASS188**

PER:  
FOR:

# ASSA

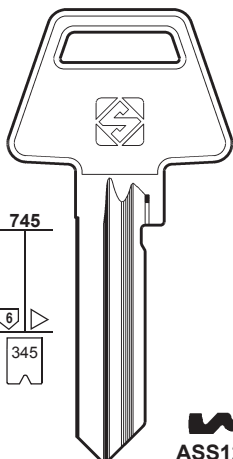

**ASS155**  
PK

**ASS122R**  
UM

**ASS155R**  
UK

**ASS142** TW .....  
123456789  
05-04

**ASS143**  
05-05

**ASS144** TW .....  
123456789  
05-13

**ASS145**  
14-01

**ASS146**  
14-09

**ASS147**  
14-25

**ASS150**  
11-08

**ASS151**  
11-01

**ASS152**  
11-32

**ASS153**  
11-14

**ASS154**  
11-12

**ASS172**  
05-14

**ASS174**  
14-33

**ASS175R**  
UL

**ASS176**  
TM

**ASS177**  
TK

**ASS178**  
TL



22

PER / FOR

ASSA (SE)

+ RUKO (162)

+ TEKA (181)

PER:  
FOR:

ASSA

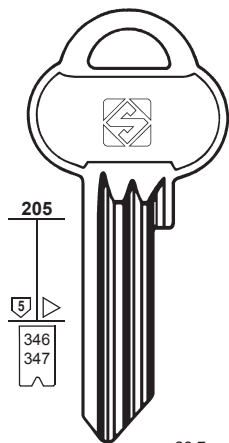

mm 28,7

560.

..... 1-2-3-4-5-6-7

..... 1-2-3-4-5-6-7-8

B  ASS9R

F  ASS31R

G  ASS11

K  ASS33

N  ASS2

R  ASS10R

A  ASS9

E  ASS31

M  ASS11R

L  ASS33R

P  ASS2R

S  ASS10

PER:  
FOR:

ASSA

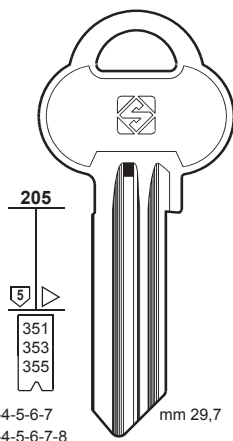

mm 29,7

560.

..... 1-2-3-4-5-6-7

..... 1-2-3-4-5-6-7-8

U  ASS7

V  ASS35R

Z  ASS37

NN  ASS44

W  ASS7R

T  ASS35

X  ASS37R

PP  ASS44R

D  ASS64

RR  ASS69

H  ASS64R

SS  ASS69R

MM  ASS68R

FG  ASS180R

5FG . . . . . 10000-99809

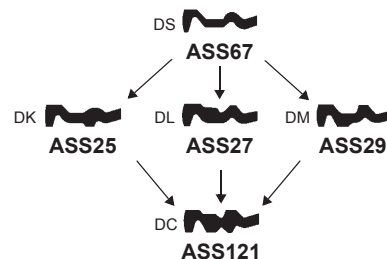
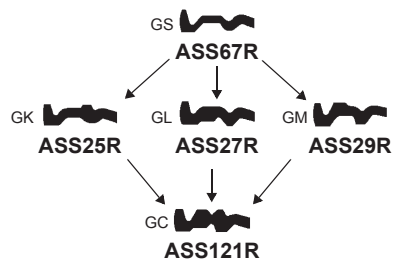
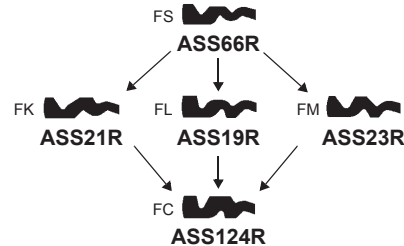
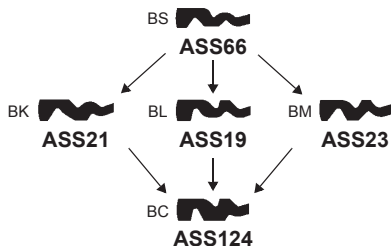
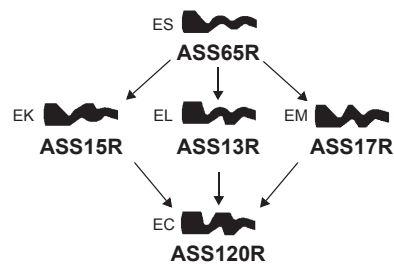
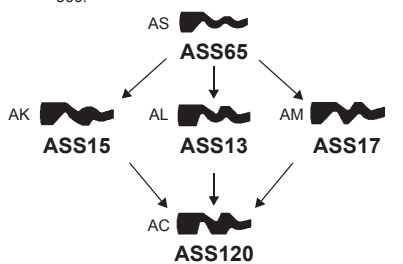



PER:  
FOR:

# ASSA



# 23

PER / FOR

**ASSA (SE)**

+ RUKO (162)

+ TEKA (181)

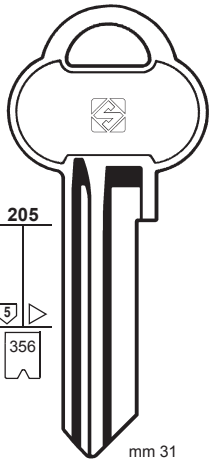

560.  
..... 1-2-3-4-5-6-7

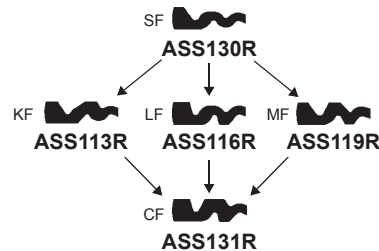
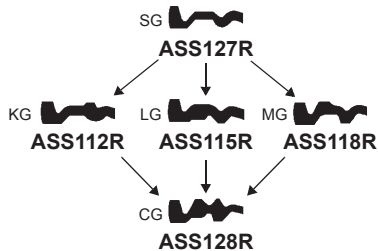
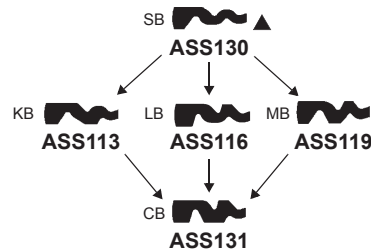
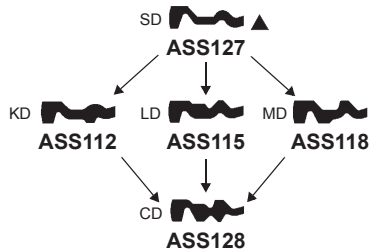
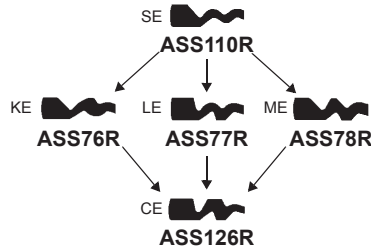
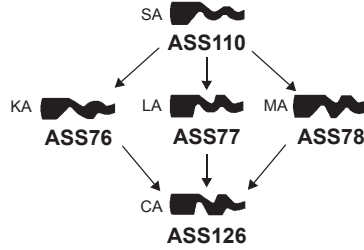
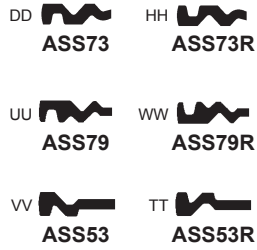

PER:  
FOR:

# ASSA

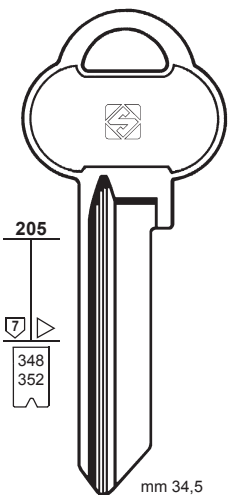

760.  
..... 1-2-3-4-5-6-7

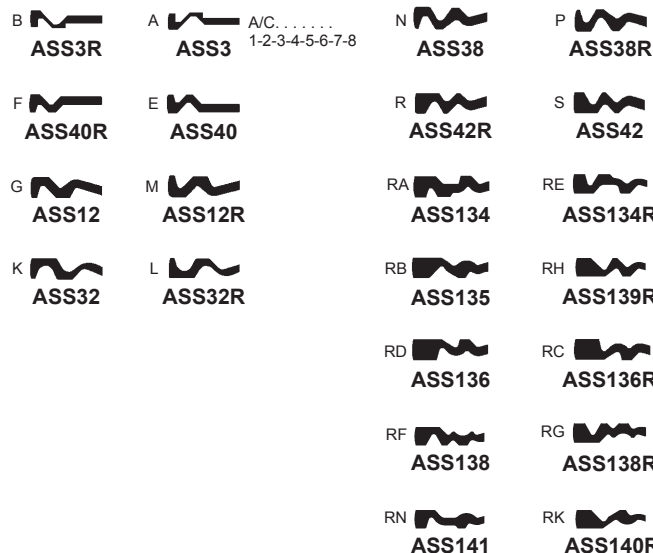



PER:  
FOR:

# ASSA

# 24

PER / FOR

ASSA (SE)

+ RUKO (162)

+ TEKA (181)

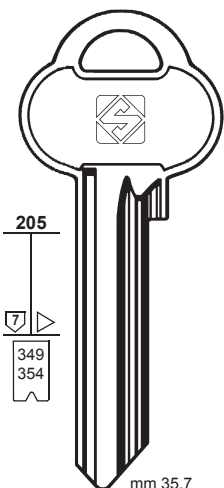

mm 35,7

760.



**ASS108**

..... 1-2-3-4-5-6-7  
..... 1-2-3-4-5-6-7-8



**ASS4**



**ASS4R**



**ASS8**



**ASS8R**



**ASS34R**



**ASS34**



**ASS36**



**ASS36R**



**ASS45**



**ASS45R**



**ASS39**



**ASS39R**



**ASS109**



**ASS48R**

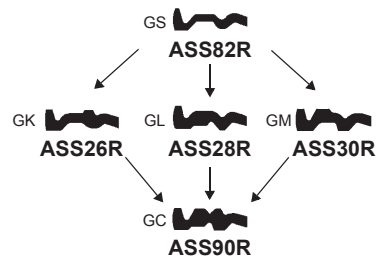
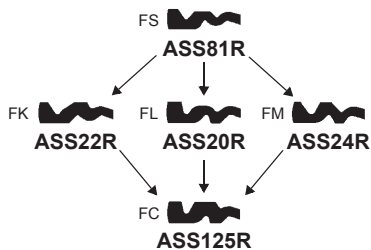
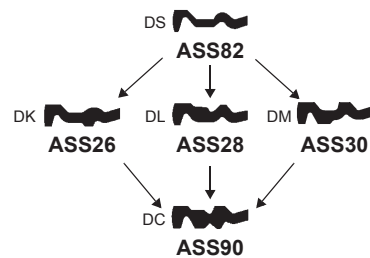
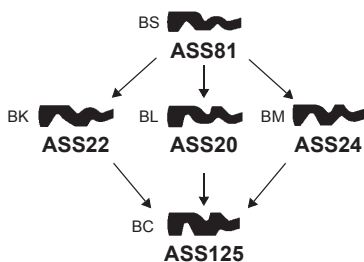
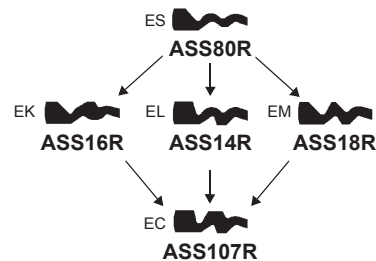
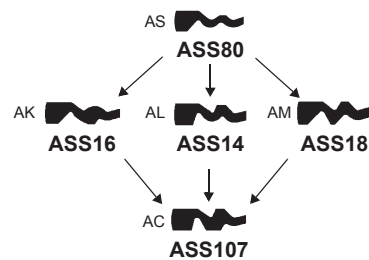

PER:  
FOR:

# ASSA



# 25

PER / FOR

**ASSA (SE)**  
HABO  
+ RUKO (162)  
+ TEKA (181)

**ASTRA (AU)**

**ATAL (FR)**  
 KIFERM (117)  
 LAS (121)  
 L & F (128)  
 RENZ (159)  
 VACHETTE (198)

**ATAY (RU)**

**ATLAS (FR)**  
 SUREX (178)

**ATRA (IT)**  
 ISEO (109)

**ATP (IT)**  
 CITY (58)

**AUBERT (FR)**  
 ZENITH (222)

**AUDOLI (IT)**

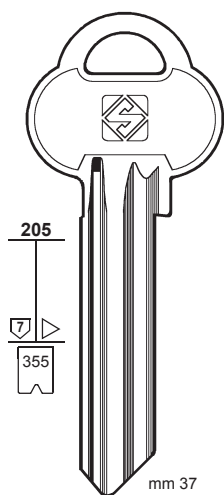

1DG ..... 1-83499  
0FG ..... 10000-99809  
ODG ..... 1-99999  
DS ..... 1-78678  
DJ ..... 1-1234567  
SE ..... 00001-43800  
..... 1-2-3-4-5-6-7  
..... 1-78670

- |                  |                   |
|------------------|-------------------|
| DD <b>ASS52</b>  | HH <b>ASS52R</b>  |
| PA <b>ASS102</b> | PB <b>ASS102R</b> |
| PD <b>ASS183</b> | PE <b>ASS183R</b> |
| PF <b>ASS103</b> | PG <b>ASS103R</b> |
| PH <b>ASS104</b> | PN <b>ASS104R</b> |
| PR <b>ASS105</b> | PT <b>ASS105R</b> |
| UU <b>ASS94</b>  | WW <b>ASS94R</b>  |
| VV <b>ASS51</b>  | TT <b>ASS51R</b>  |
|                  | XX <b>ASS106R</b> |

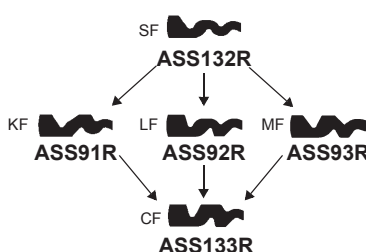
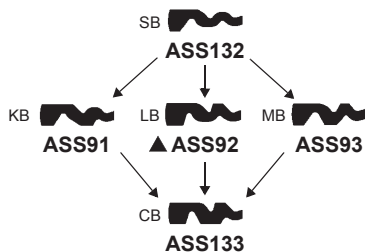
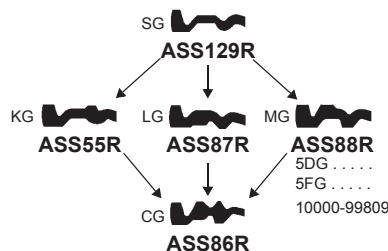
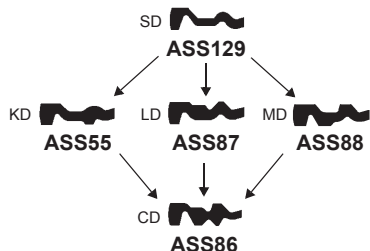
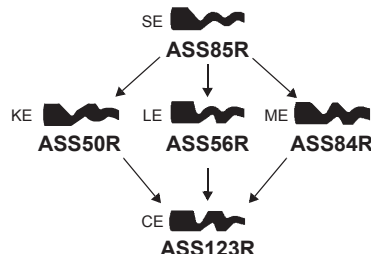
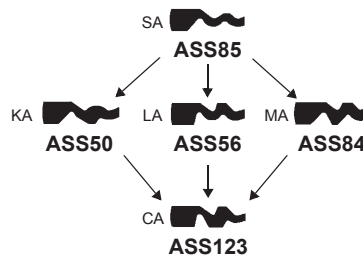

HABO

PER:  
FOR:

## ASTRA

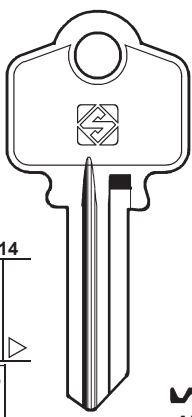

**AT1**  
..... 0-1-2-3-4-5-6-7  
..... 1-2-3-4-5-6-7-8

**AT2R**  
..... 12345678

**AT1R**  
..... 1-2-3-4-5-6-7-8

## ATAY

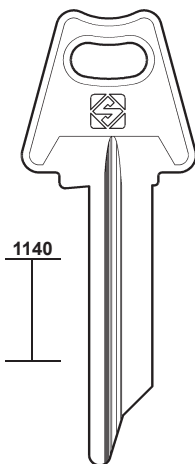

**ATA1**      **ATA1R**

## AUDOLI

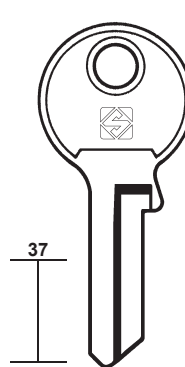

**AUD1**



26

PER / FOR

AUMON (ES)

AUSTRAL LOCK (AU)

AVA-CHUBB (SE)

AVANGARD (RU)

AVOCET (GB)  
W.M.S.

AXA (NL)  
+ BATON (31)

AZBE (ES)  
+ TOK-WINKHAUS (187)

PER:  
FOR:

AUMON

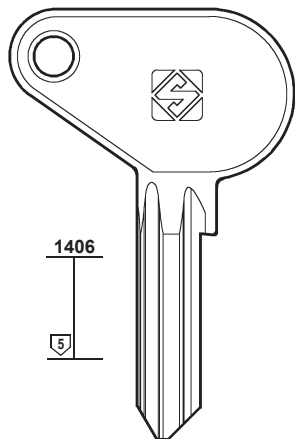

AUN1

AUSTRAL LOCK

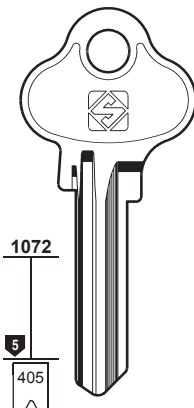

AUS1

..... 0-1-2-3-4-5-6-7-8-9-A

AVA-CHUBB

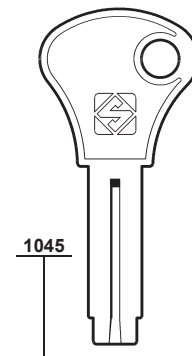

CHU7



PER:  
FOR:

AVANGARD

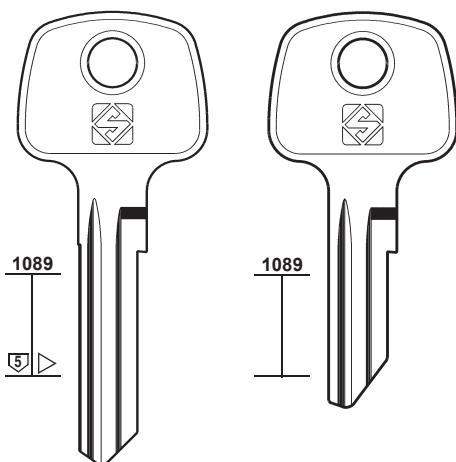

AV1



AV1R



AV2

AVOCET

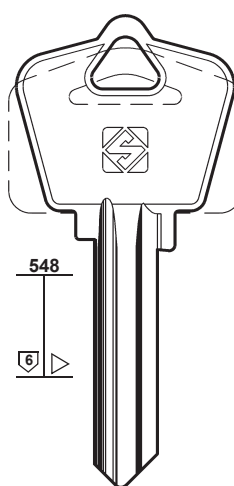

AVC1

W.M.S.

AXA

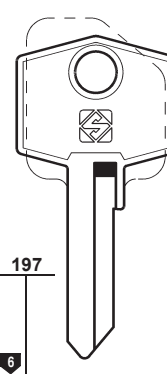

AX2

PER:  
FOR:

AXA

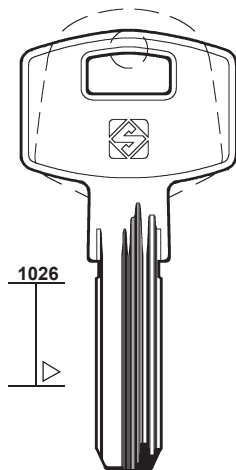

AX12



AZBE

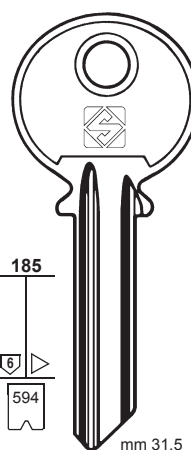

X ..... mm 31,5  
Y .....  
1-2-3-4-5-6-7-8



AZ1  
X



AZ1R  
Y

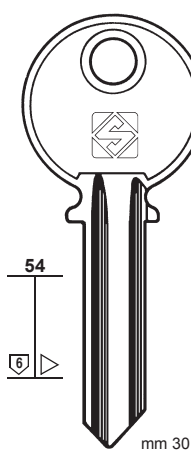

AZ3



AZ3R

PER:  
FOR:

### AZBE

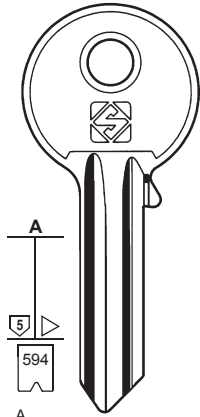

A ..... mm 26,3  
B .....  
1-2-3-4-5-6-7-8



AZ2  
A



AZ2R  
B

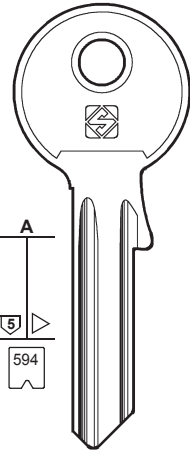

AZ2X

A ..... 12345678

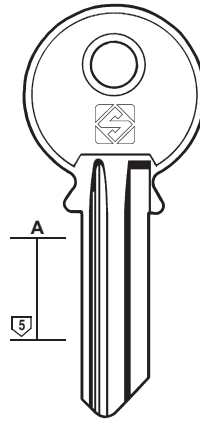

AZ4



# 27

PER / FOR

AZBE (ES)  
CAVERS

+ TOK-WINKHAUS (187)

AZMA (FR)

VACHETTE (201)

PER:  
FOR:

### AZBE

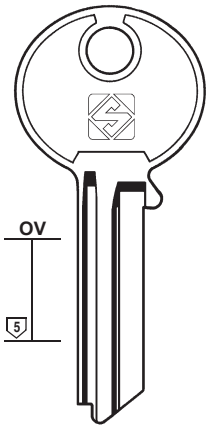

AZ5

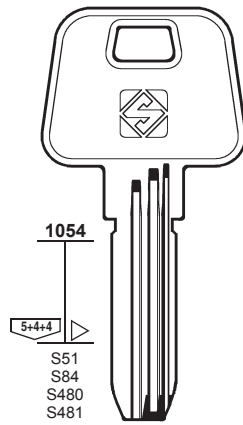

AZ6

HS-4



AZ6R



CAVERS

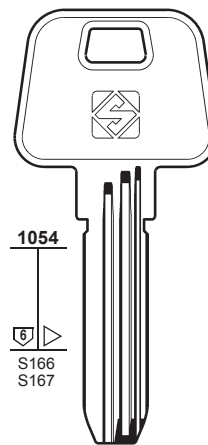

AZ7

HS-6



CAVERS

PER:  
FOR:

### AZBE

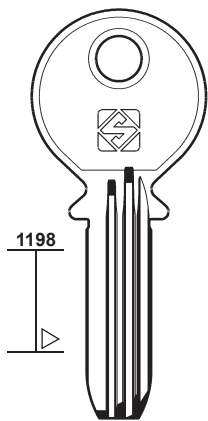

AZ8

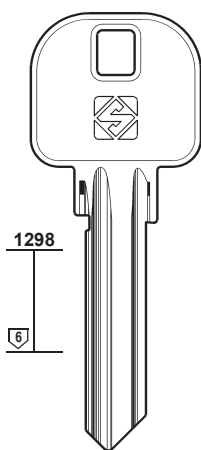

AZ9



AZ9R

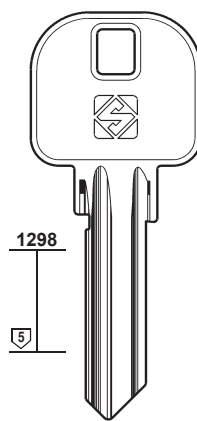

AZ10



AZ10R

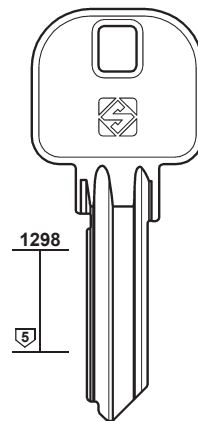

AZ11



28

PER / FOR

BAAL (CH)  
VÖGEL

BAB (DE)  
CORONA  
ESS  
+ CORONA (63)

PER:  
FOR:

BAAL

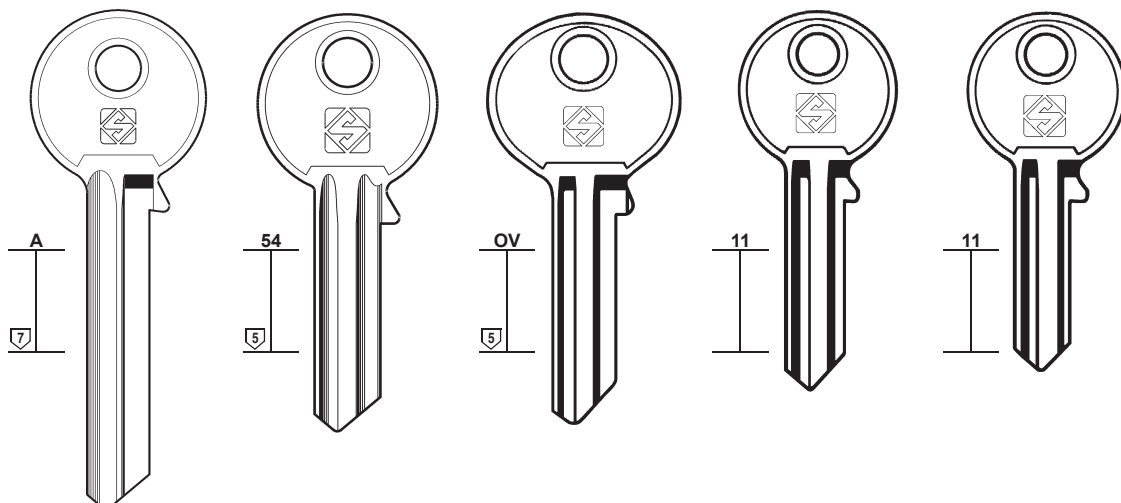

BAL7

BAL5

BAL1 BAL1R

BAL2

BAL3

VÖGEL

PER:  
FOR:

BAAL

BAB

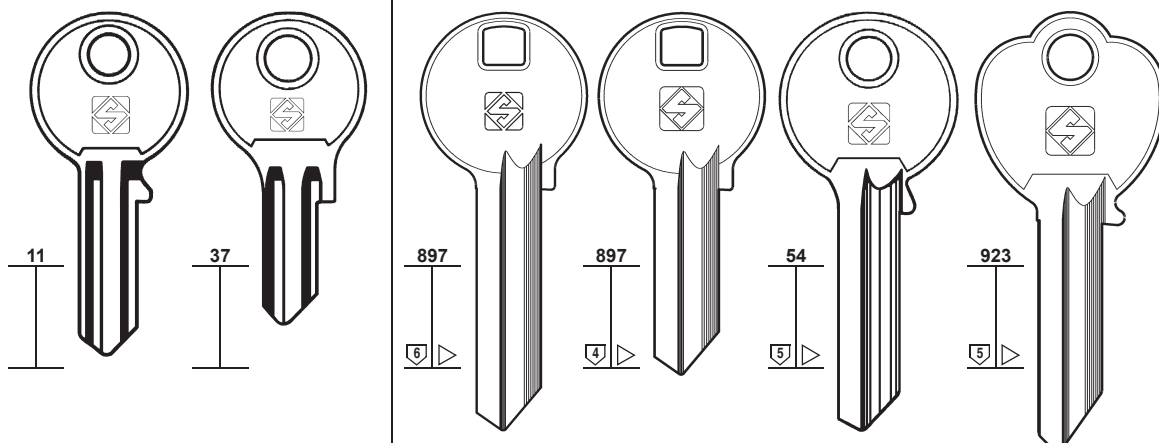

BAL4

BAL6

BAB6R

BAB4R

BAB7R

BAB5R

BAB2R

BAB18R

ESS

PER:  
FOR:

BAB

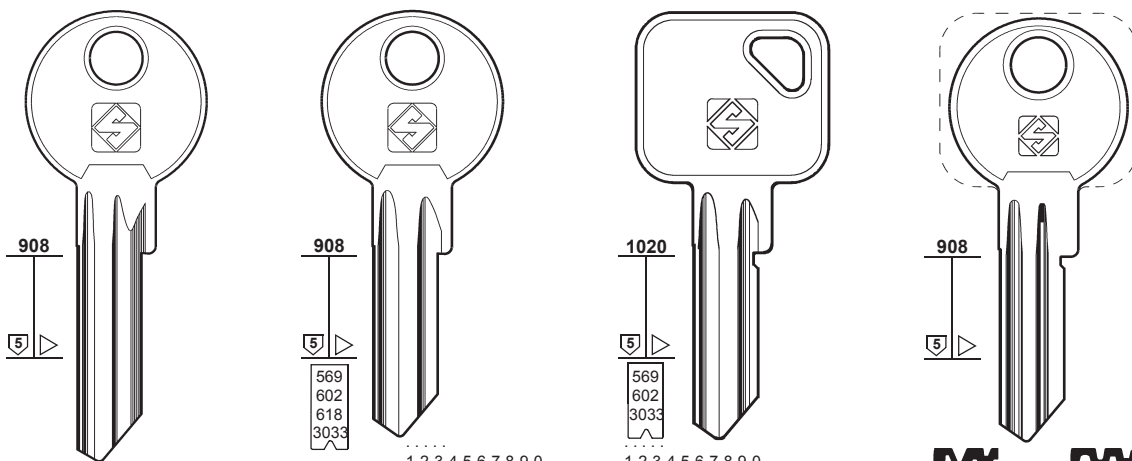

BAB14

BAB13

BAB13R

BAB25

BAB25R

BAB27

BAB29

BAB28R

ZEISS-IKON

CORONA - ZEISS-IKON

Copyright by Silca S.p.A. 2018 - All Rights Reserved

PER:  
FOR:

### BAB

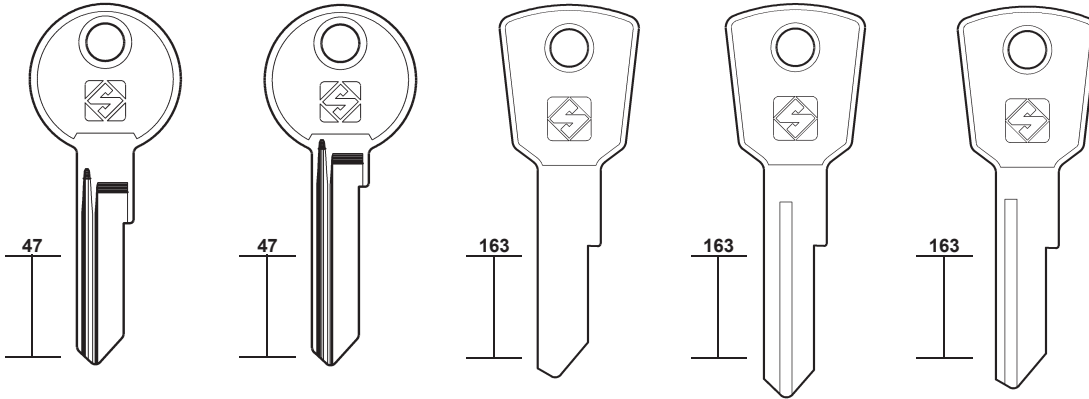

BAB15

BAB16

BAB19

BAB20

BAB21-3  
 BAB21-5

BAB21-4

HALLE

HALLE

HALLE



# 29

PER / FOR

BAB (DE)  
HALLE  
+ CORONA (63)

PER:  
FOR:

### BAB

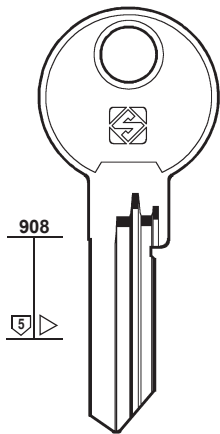

BAB26R-1  
7

BAB26R-2  
1

BAB26R-8

BAB26R-14

BAB26R-20

BAB26R-3  
4

BAB26R-9

BAB26R-15

BAB26R-21

BAB26R-4  
12

BAB26R-10

BAB26R-16

BAB26R-22

BAB26R-5  
3

BAB26R-11

BAB26R-17

BAB26R-23

BAB26R-6  
6

BAB26R-12

BAB26R-18

BAB26R-7

BAB26R-13

BAB26R-19

PER:  
FOR:

### BAB

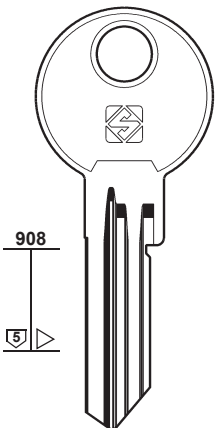

BAB30R-1

BAB30R-3

BAB30R-10

BAB30R-2

BAB30R-4

BAB30R-11

BAB30R-5

BAB30R-6

BAB30R-7

BAB30R-8

BAB30R-9

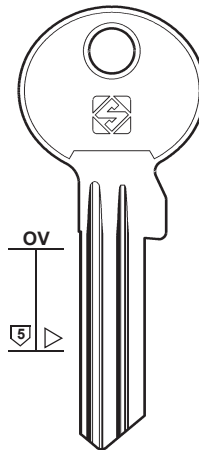

BAB31  
N26

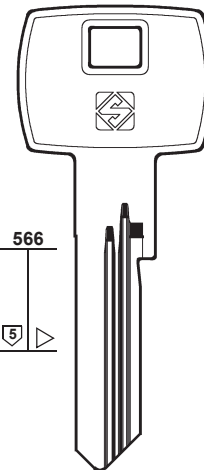

BAB36R



30

PER / FOR

**BABY CLIP** (FR)  
EFSA  
ETF

**BAGEM** (ES)  
ABC (4)

**BALDWIN** (US)  
SCHLAGE (166)

**BALING LOCKS** (CN)  
T-KEY

**BALLY** (IT)  
TAMPALINI (179)  
ZANI (220)

**BANE SEKULIĆ** (RS)  
BSS (40)

**BANHAM** (GB)  
SIDLEEN (169)

**BANKA** (IT)  
GIUSSANI (96)

**BAODEAN** (CN)  
CINA (54)

**BAODELI** (CN)

**BARAS** (GR)

**BARGMAN** (US)  
ILCO (106)

**BARRO** (DE)  
DOM (68)

**BASI** (DE)  
+ ABUS (8)  
+ BUGA (40)  
+ CISA (58)  
+ EURO-LOCKS (79)  
+ L & F (129)  
+ SATURN (165)

PER: **BABY CLIP**

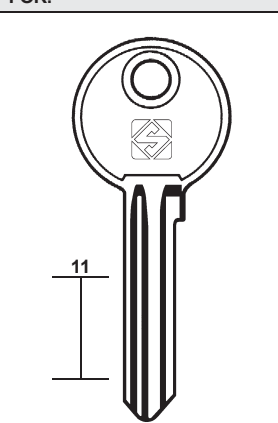

EFSA - ETF

PER: **BALING LOCKS**

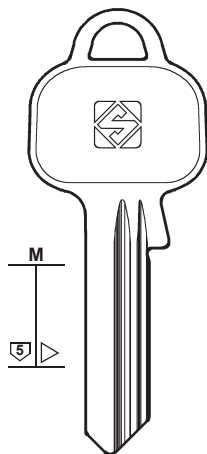

T-KEY

PER: **BANHAM**

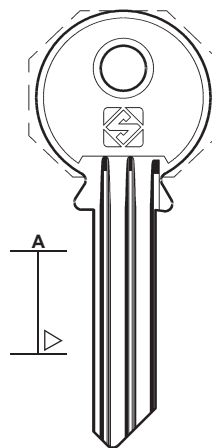

THIN  
THICK

PER: **BAODEAN**

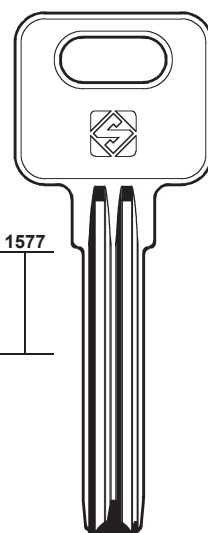

BAE1

PER: **BAODEAN**

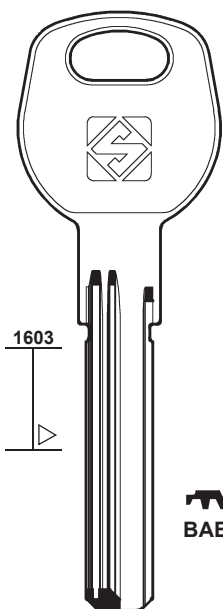

BAE2R

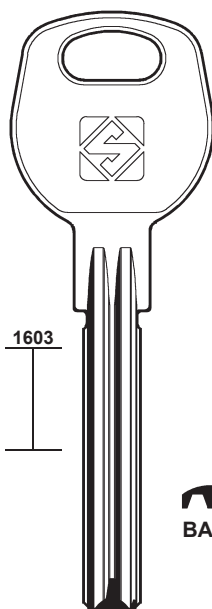

BAE3



PER: **BAODELI**

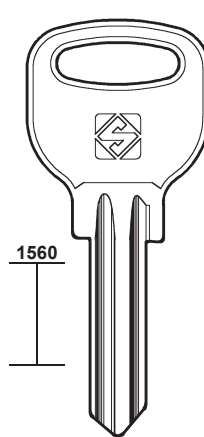

BAD1



BAD1R

PER: **BARAS**

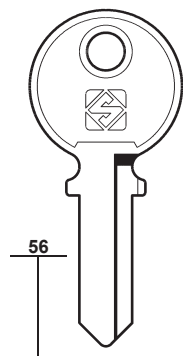

BAR1



BAR1R

PER: **BASI**

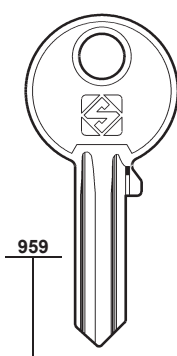

BAI2

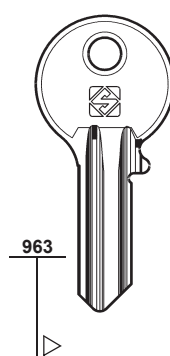

BAI3

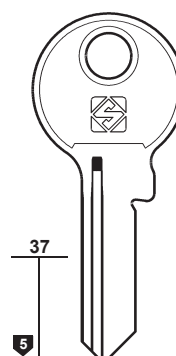

BAI4R



mm 40

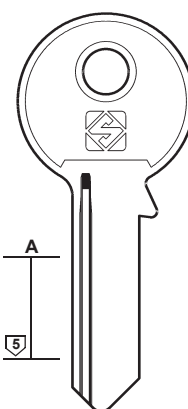

BAI5R



mm 50



PER:  
FOR:

# BASI

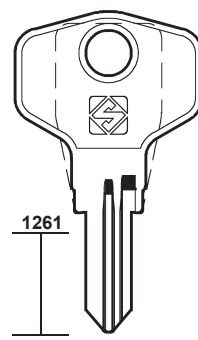
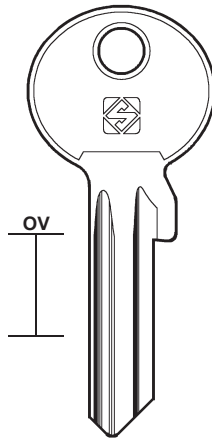
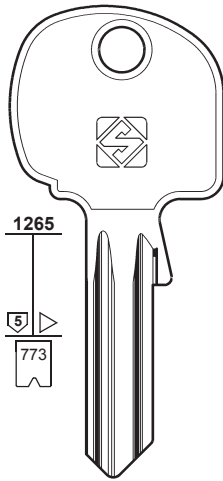
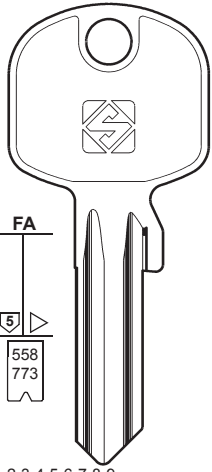

..... 1-2-3-4-5-6-7-8-9  
..... 1-2-3-4-5-6-7-8-9-0  
..... 800001-803640

..... 1-2-3-4-5-6-7-8-9-0  
..... 800001-803640



CIC



# 31

PER / FOR

## BASI (DE)

- CIC
- + ABUS (8)
- + BUGA (40)
- + CISA (58)
- + EURO-LOCKS (79)
- + L & F (129)
- + SATURN (165)

## BASCO (US)

BIZERBA  
ELMO

## BASSI (IT)

- + GEVY (95)

## BASTA (IE)

BASTA (DK)  
EURO LOCKS

BATON (TW)  
AXA

PER:  
FOR:

# BASCO

# BASSI

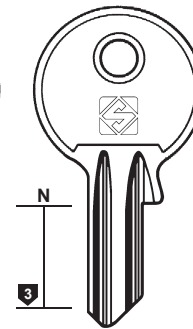
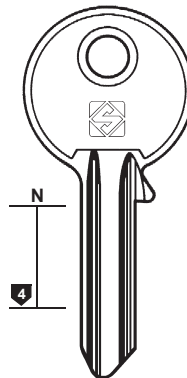
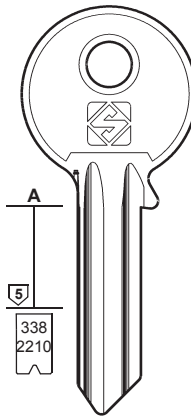
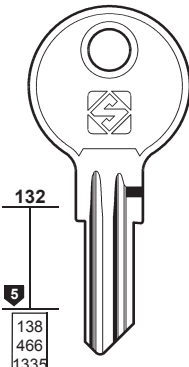
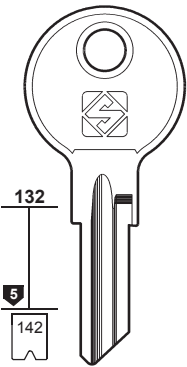

AN ... 1-500  
HC ... 0-499  
LL ... 1-326  
LL ... 1-200  
LL ... 1-200  
DD ... 1-250  
GC ... 101-150  
CH ... 751-1178  
RC ... 501-750

..... 0-1-2-3-4-5  
..... 1-2-3-4-5



ELMO

BIZERBA - ELMO

PER:  
FOR:

# BASTA (IE)

# BASTA (DK)

# BATON

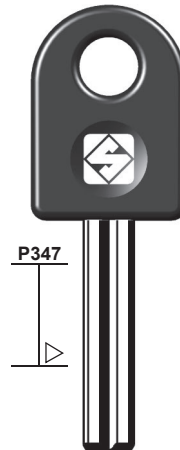
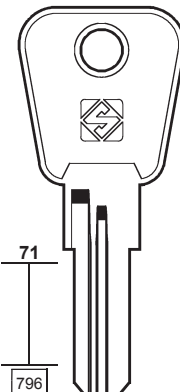
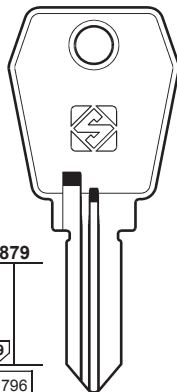
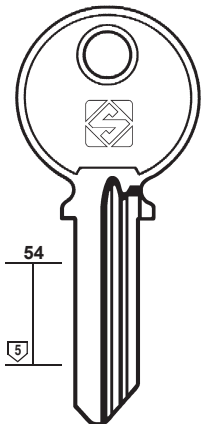

M ... 1-1000  
V ... 1-1000  
W ... 1-1000  
C ... 1-1000

C ... 1-1000

EURO LOCKS



AXA





32

PER / FOR

BATON (TW)

BATU (ES)

👁️ CISA (57)

👁️ IFAM (106)

BECCARINI (IT)

BEDI (FR)

👁️ YETI (218-219)

BELL (TW)

+ 👁️ YETI (218-219)

BELLEVILLE (USA)

BENCO (NL)

👁️ YETI (219)

BENDIX (US)

👁️ YALE (213)

BERAM (TW)

👁️ VIRO (206)

BERETTA (IT)

👁️ FASEM (86)

BERRY (DE)

👁️ BKS (34)

👁️ CES (47)

BERTO (CH)

PER: BATON

FOR:

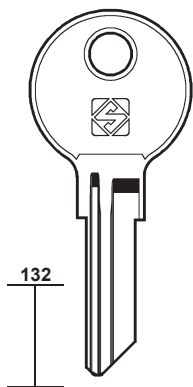

BAT2

PER: BECCARINI

FOR:

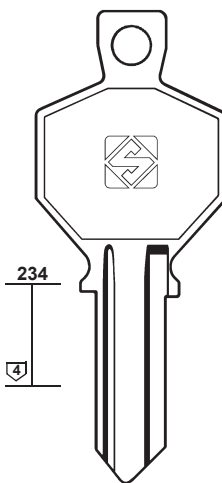

BN1

BN1R

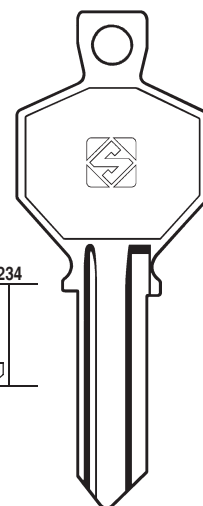

BN2

BN2R

PER: BELL

FOR:

BELL

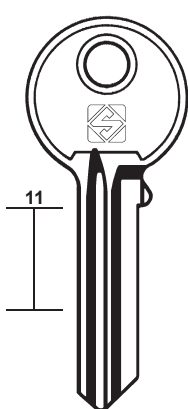

BLL1

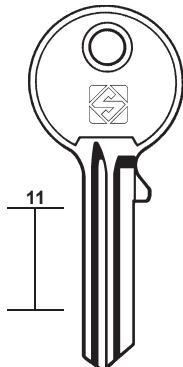

BLL2

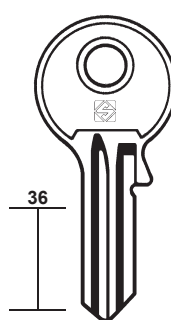

BLL3

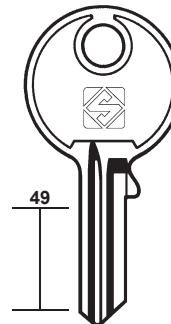

BLL4



BLL5



PER: BELLEVILLE

FOR:

BELLEVILLE

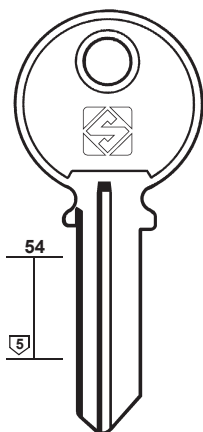

BLV1R

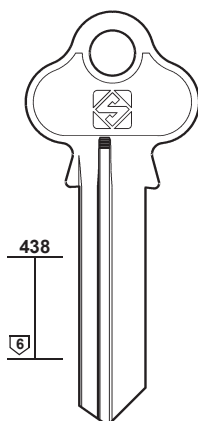

BLV2R

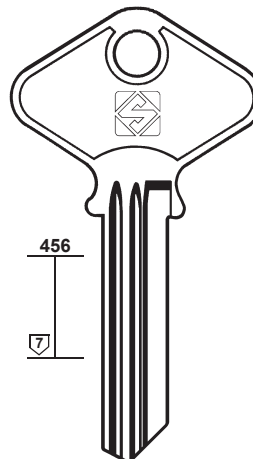

BLV3

PER: BERTO

FOR:

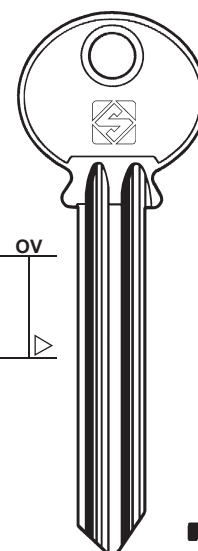

BRT1

PER:  
FOR: **BERTO**

**BEST**



**33**

PER / FOR

**BERTO (CH)**

**BERTOLOTTI (IT)**

TICINO (182)

**BEST (US)**

FALCON

**BETA (IT)**

PICARD

+ CORNI (62)

**BEY (TR)**

**BIB (IT)**

MERONI (136)

**BIBERING (DE)**

TAS (180)

**BIELLE (IT)**

FASEM  
OMIV  
P.C.

**BIFFAR (DE)**

TOK-WINKHAUS (187)

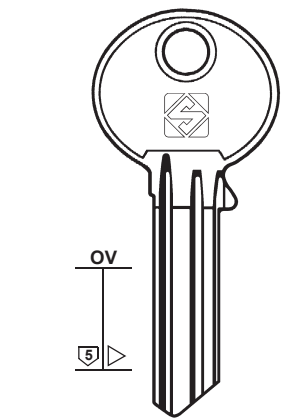

OV  
5



**BRT2**



**BRT3**



**BRT4**

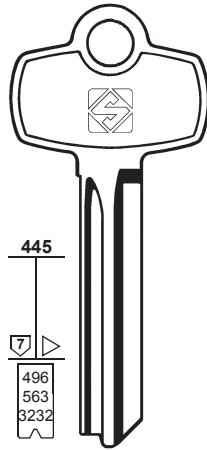

445  
496  
563  
3232  
7

..... 0-1-2-3-4-5-7-8-9  
..... 0-1-2-3-4-5  
..... 0-1-2-3-4-5-6-7-8-9



**BES1**



**BES2**



**BES3**



**BES4**



**BES5**



**BES6**



**BES7**



**BES8**



**BES9**



**BES10**



**BES11**



**BES12**



**BES16**



**BES17**



**BES18**

FALCON

PER:  
FOR: **BETA**

**BETA**

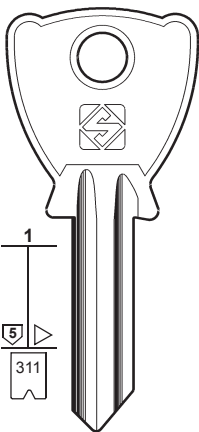

1  
5  
311



**BE202 BE203**

..... 1-2-3-4-5-6

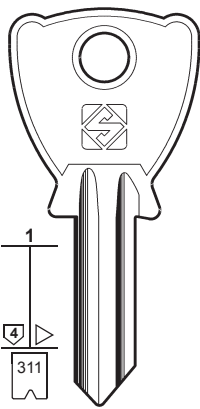

1  
4  
311



**BE200 BE201**

..... 1-2-3-4-5-6

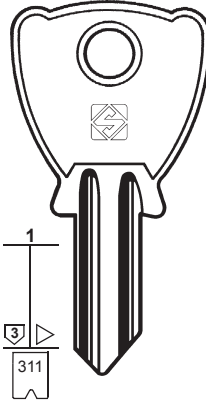

1  
3  
311



**BE4R**

..... 1-2-3-4-5-6

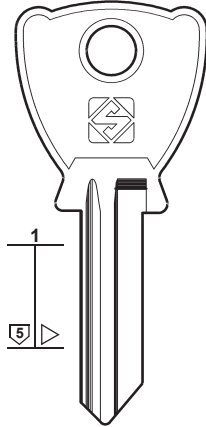

1  
5



**BE3**

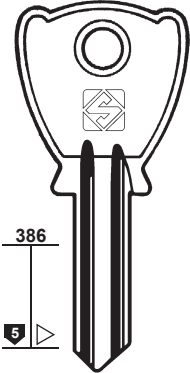

386  
5



**BE1 BE1R**

PICARD



PER:  
FOR: **BEY**

**BEY**

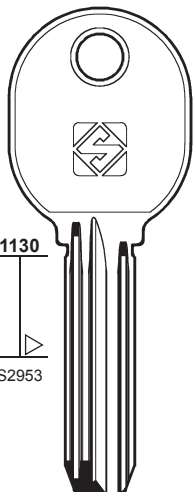

1130  
S2953



**BEY1R**

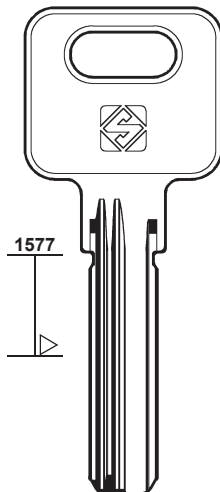

1577



**BEY2R**



PER:  
FOR: **BIELLE**

**BIELLE**

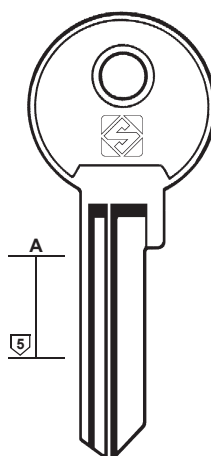

A  
5



**BI110**

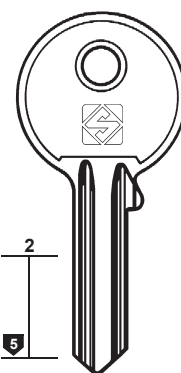

2  
5



**BI062**



**BI063**

FASEM - OMIV - P.C.



# 34

PER / FOR

**BILMA** (ES)

**BIGLA** (CH)

**BIRD** (HK)

YALE (212)

**BIZERBA** (HK)

BASCO (31)

**BKS** (DE)

BERRY  
DAMM  
GEBÄ  
HÄFELE  
HÖHRMANN  
YALE

+ LITTO (125)

+ YALE (212-213)

PER: **BILMA**  
FOR:

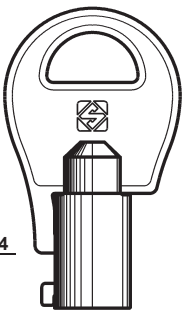

1314

S344 ..... 1-2-3-4-5-6  
S1290 ..... X-1-3-4-5-6

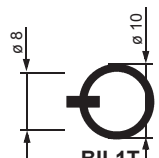

ø 8  
ø 10  
BIL1T

PER: **BIGLA**  
FOR:

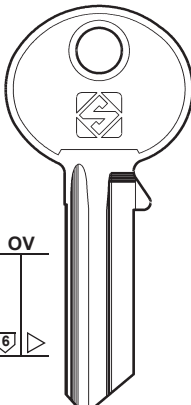

OV

5



BG1

PER: **BKS**  
FOR:

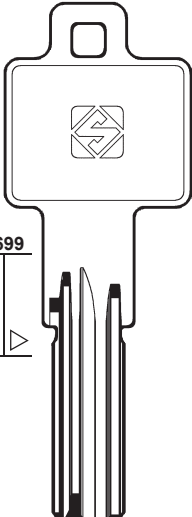

1699

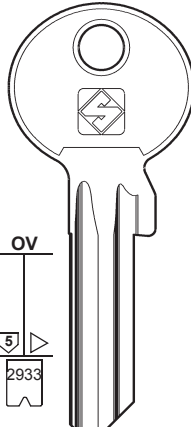

OV

5

2933



BK61



BK1X  
PZ

1234567890ABCDEFGHIJL



BK49R



BK48R



BK27



BK23R



BK22R



BK21R



BK13  
0211

PER: **BKS**  
FOR:

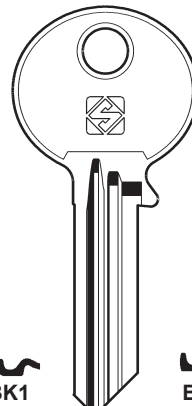

OV

5

344  
614  
534  
2933  
2936

PZ

**BK1**  
..... 01234567  
..... 0123456789  
..... 1234567890ABCDEFGHIJL  
..... 050001-80453



BK1R  
38



BK2R



YA9



BK3-1



BK3-7



BK7R-1



BK7R-6



BK3-2



BK3-8



BK7R-2



BK7R-7



BK3-3



BK3-9



BK7R-3



BK7R-8



BK3-4



BK3-10



BK7R-4



BK7R-9



BK3-5



BK3-11



BK7R-5



BK7R-10



BK3-6



BK3-12

Serie O  
BERRY - DAMM - GEBÄ - HÖHRMANN - YALE

PER: **BKS**  
FOR:

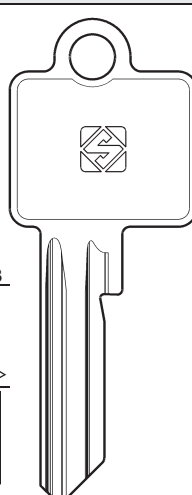

1423

5

344  
614  
534  
2933  
2936

PZ

**BK15**  
..... 01234567  
..... 0123456789  
..... 1234567890ABCDEFGHIJL  
..... 050001-80453



BK60



BK18  
0212



BK17  
0213



BK16  
0214

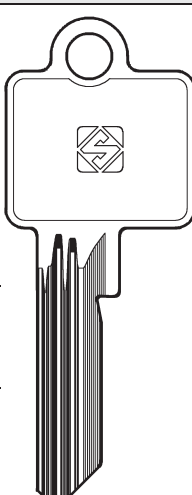

1423

5



BK20  
07



BK28  
17



BK29  
19



BK30  
01



BK31  
02



BK32  
09



BK34  
14



BK36  
04



BK38  
06



BK37  
05



BK52  
10



BK53  
16



BK99-03  
03



BK99-08  
08



BK100

HÄFELE

Serie 42

PER:  
FOR:

### BKS

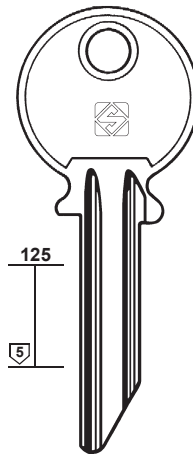
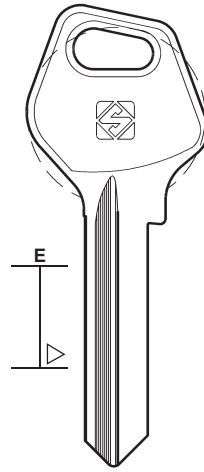
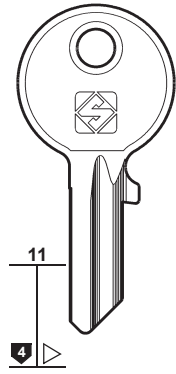
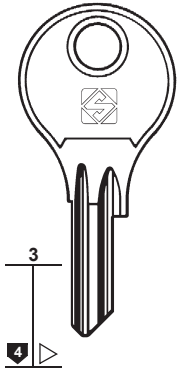

METEOR - YALE



# 35

PER / FOR

**BKS** (DE)  
**METEOR**  
**YALE**  
 + LITTO (125)  
 + YALE (212-213)

PER:  
FOR:

### BKS

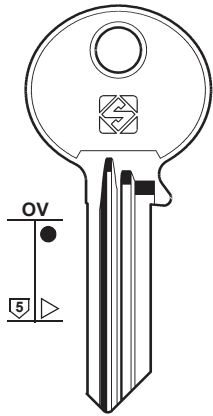

Serie 1000



PER:  
FOR:

### BKS

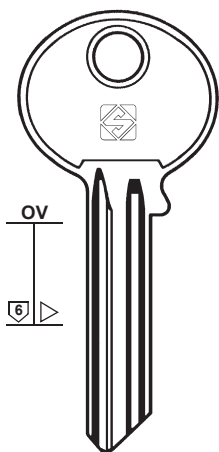

Serie 1000





36

PER / FOR

**BKS** (DE)

+ LITTO (125)

+ YALE (212-213)

**BLASER** (CH)

VADETO

WILKA

**BLINKY** (CN)

**BLOCKSHAFT** (IT)

**BLOCTOUT** (FR)

+ BRICARD (39)

**BLOCUS** (FR)

+ PREFER (157)

+ RONIS (161)

**BMB** (DE)

**BODA** (FI)

+ CES (47-49-50)

PER:  
FOR:

**BKS**

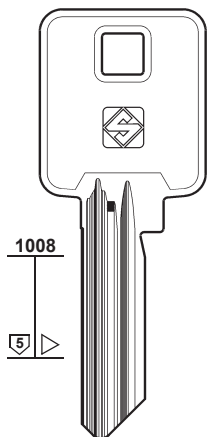

1008



**BK10-00**  
Serie 2000

**BK10-01**

**BK10-07**

**BK10-13**

**BK10-19**

**BK10-02**

**BK10-08**

**BK10-14**

**BK10-20**

**BK10-03**

**BK10-09**

**BK10-15**

**BK10-21**

**BK10-04**

**BK10-10**

**BK10-16**

**BK10-22**

**BK10-05**

**BK10-11**

**BK10-17**

**BK10-23**

**BK10-06**

**BK10-12**

**BK10-18**

**BK10-30**

PER:  
FOR:

**BLASER**

**BLINKY**

**BLOCKSHAFT**

**BLOCUS**

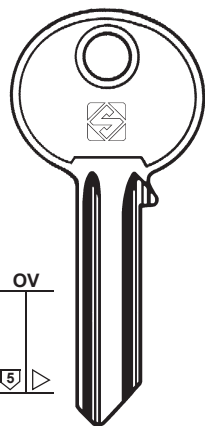

OV



**BLA3**

**BLA1**

**BLA2**  
WILKA

VADETO

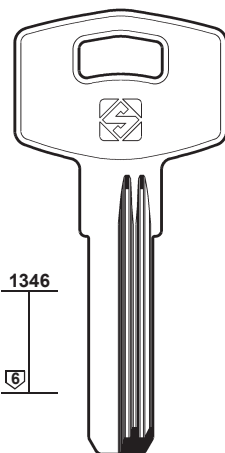

1346



**BNK1**

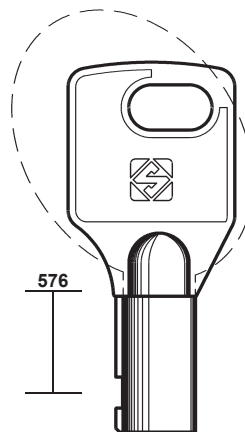

576

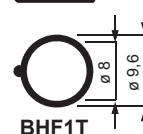

**BHF1T**

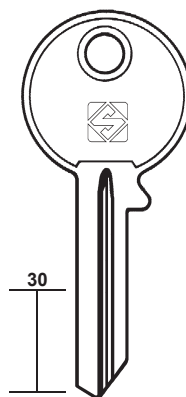

30

**BL1**

**BL1R**

PER:  
FOR:

**BMB**

**BODA**

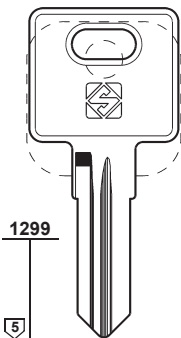

1299



**BMB1**

**BMB1R**

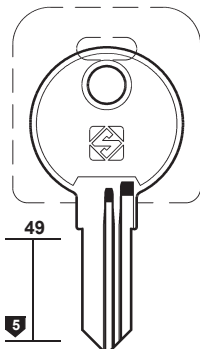

49



**BMB2**

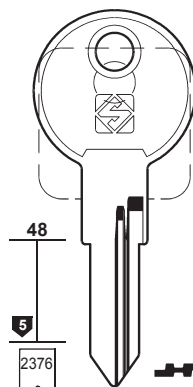

48



2376

**BMB3**  
A... 1-200

**BMB5**  
A... 401-600

**BMB3R**  
A... 1-200

**BMB4**  
A... 201-400

**BMB4R**  
... 1-2-3

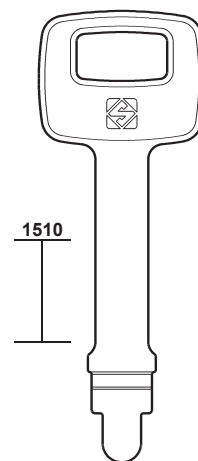

1510

**BDA10**

PER:  
FOR: **BOMMER**

**BOMORO**

**BÖRKEY**



**37**

PER / FOR

**BOMMER (US)**

**BOMORO (DE)**  
HUWIL  
LAPORTE  
PRESTA

**BÖRKEY (DE)**  
+ KABA (113)

**BOSS (IT)**  
MARLIN

**BOTT (FR)**  
CES (48)

**BRABANTIA (ES)**  
CLAUSOR (59)  
ME-FA (135)

**BRASIL (BR)**

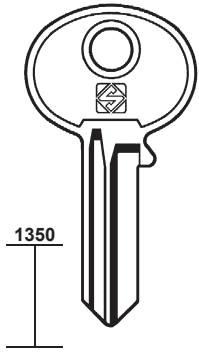

**BOR1 BOR1R**

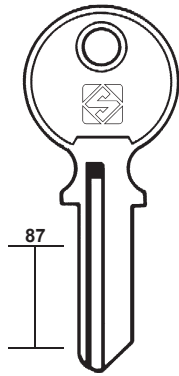

**BO2 BO2R**

LAPORTE - PRESTA

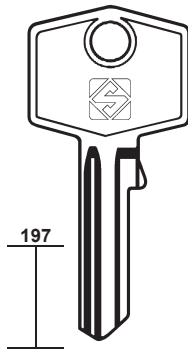

**BO6 BO6R**

HUWIL

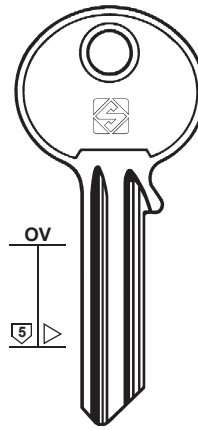

**BY1**

PER:  
FOR: **BOSS**

**BRASIL**

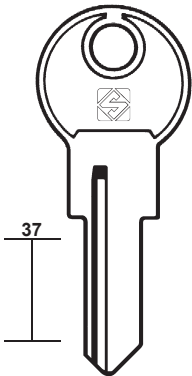

**BOS1**



mm 60

MARLIN

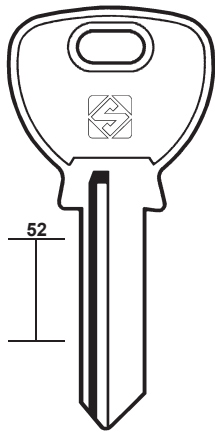

**BOS3**



mm 70-90

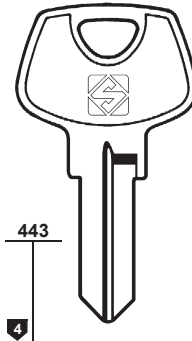

**BRA1R**

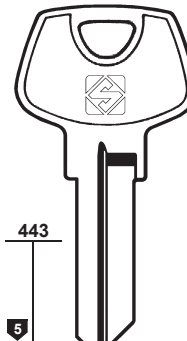

**BRA2R**

**BRA3R**

PER:  
FOR: **BRASIL**

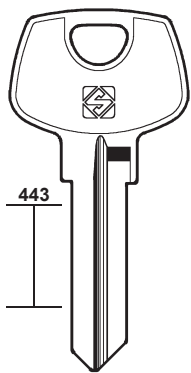

**BRA16R**

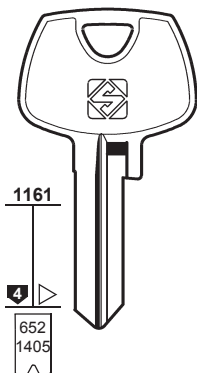

**BRA7R**

..... 1-2-3-4-5  
..... 1-2-3-4-5-6

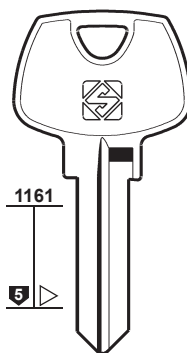

**BRA9R**

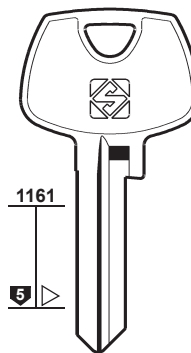

**BRA10R**



38

PER / FOR

BRASIL (BR)

BRETER (IT)  
GIUSSANI  
ZADI

+ GIUSSANI (96)

PER:  
FOR:

### BRASIL

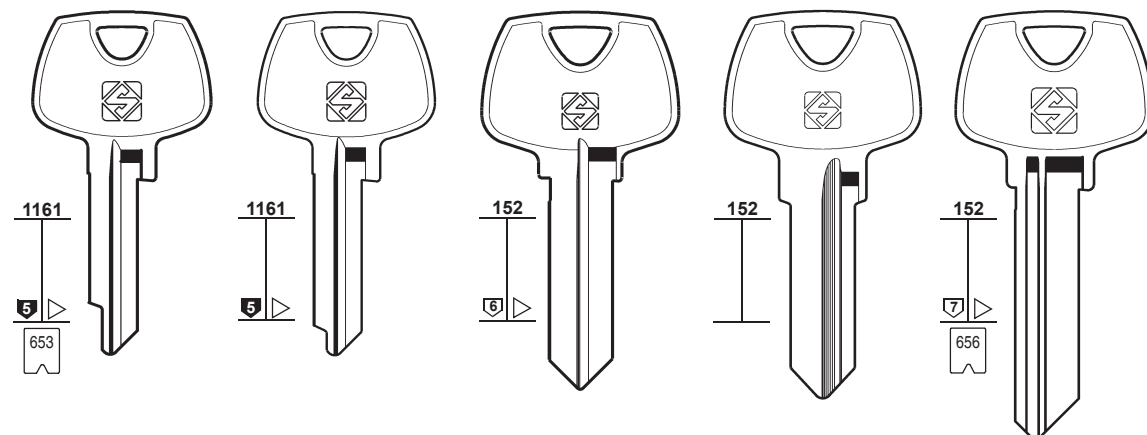

**BRA6R**

..... 1-2-3-4-5-6

**BRA11R**

**BRA8R**

**BRA15R**

**BRA5**

..... 1-2-3-4-5-6-7

PER:  
FOR:

### BRETER

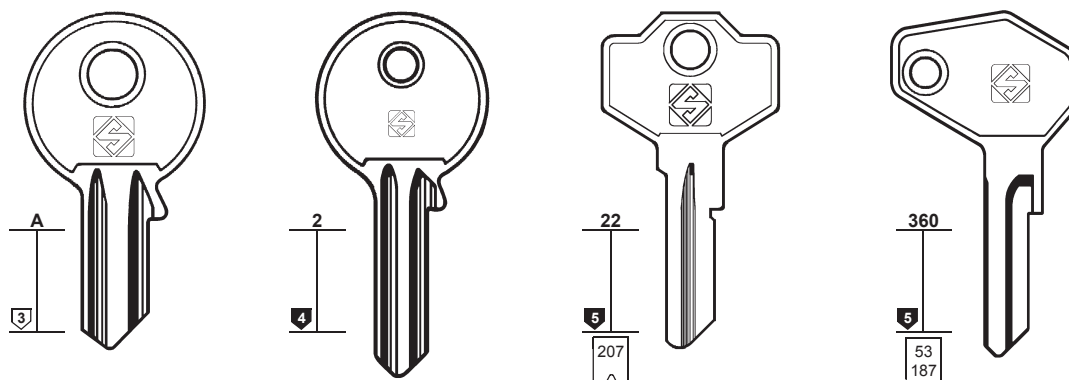

**BR1**

**GS3**   **GS3R**

**SM1**

G... 0-480  
..... 3001-3480  
G... 3001-3480  
..... 9001-9741  
G... 9001-9741

**ZD7**

..... 0001-1625  
E... 1-500  
E... 501-710  
..... 9001-9500



PER:  
FOR:

### BRETER

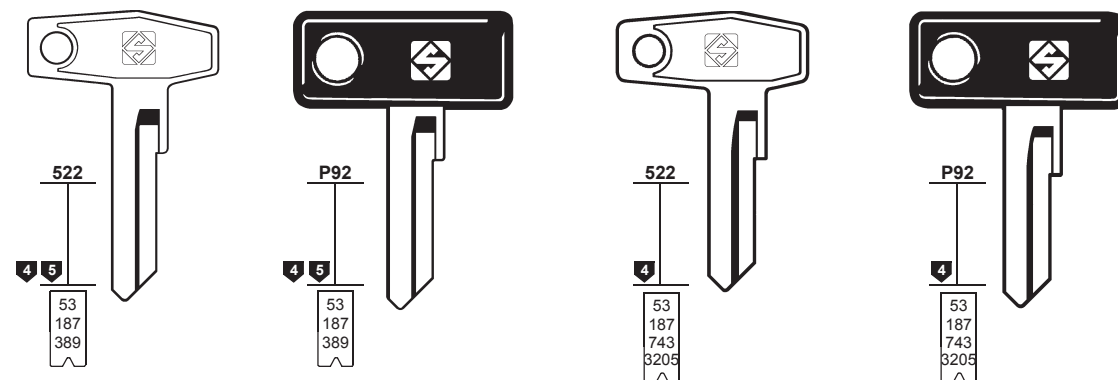

**ZD9**

..... 1-1625  
E... 500  
E... 501-710  
..... 9001-9500  
..... 5001-6278

**ZD9P**

..... 1-1625  
E... 500  
E... 501-710  
..... 9001-9500  
..... 5001-6278

**ZD11**

..... 1-1625  
E... 1-500  
..... 5001-6278  
E... 501-710  
..... 1234  
H... 100-341

**ZD11P**

..... 1-1625  
E... 1-500  
..... 5001-6278  
E... 501-710  
..... 1234  
H... 100-341



ZADI



ZADI





PER:  
FOR:

# BRICARD



# 39

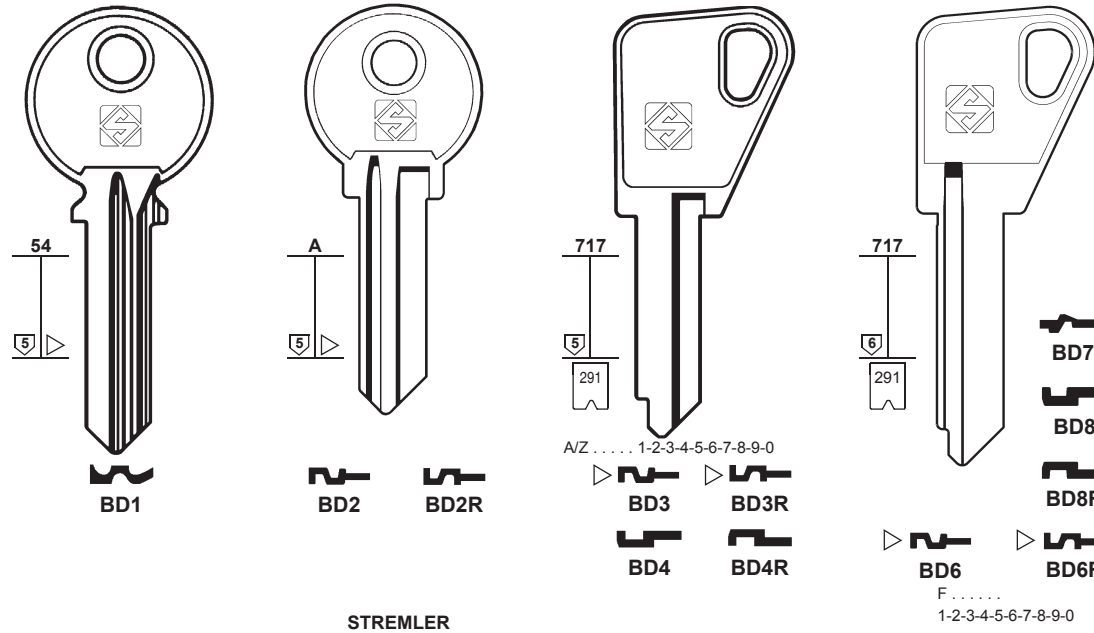

PER / FOR

- BRICARD (FR)**  
 ABUS  
 BLOCTOUT  
 INLOC  
 STREMLER  
 + ABUS (7)  
 + CISA (55-56)  
 + G.R. (99)  
 + KWIKSET (119)  
 + LOB (126)  
 + SARGENT (165)

PER:  
FOR:

# BRICARD

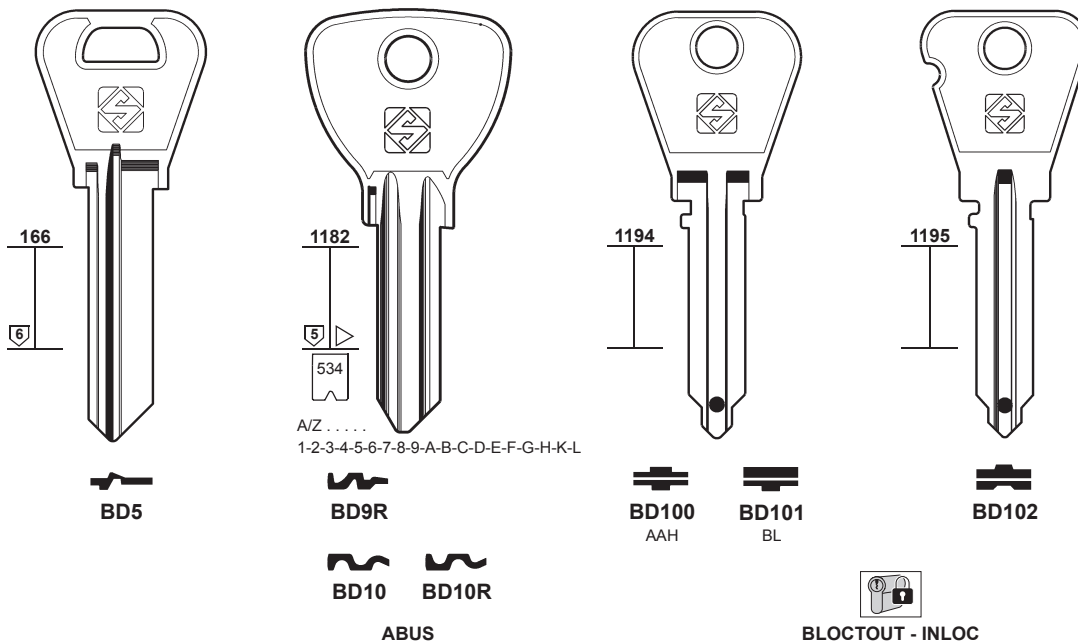

PER:  
FOR:

# BRICARD

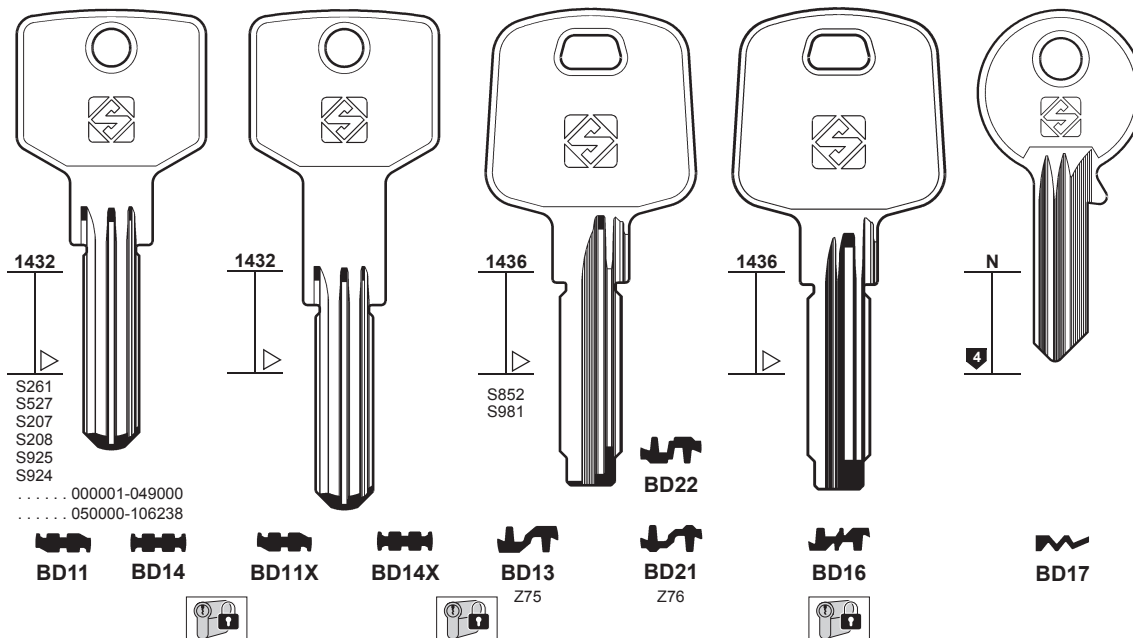



40

PER / FOR

BRISANT (GB)  
HUGO

BRUMME (DE)  
FANA  
FTH  
+ ZEISS-IKON  
(220-221)

BSS (RS)  
BANE SEKULIĆ  
+ URBIS (197)

BTV (ES)  
AGA (11)  
DOM (68)  
STS (177)

BUFFO (GR)  
ABUS (7-9)

BUG (DE)  
CORONA (63)

BUGA (FR)  
BASI  
CITY  
IFAM

PER:  
FOR:

### BRISANT

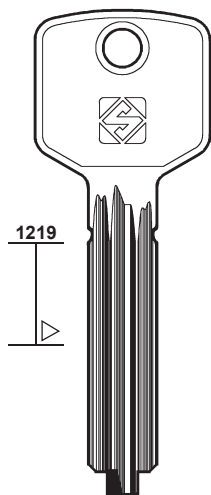

1219



BRS1R

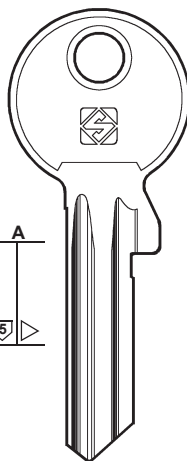

A

5



BRS3R



BRS2



HUGO

### BRUMME

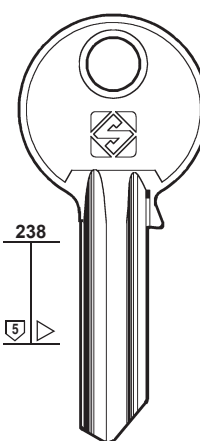

238

5



BRM1



BRM1R

FANA - FTH

PER:  
FOR:

### BSS

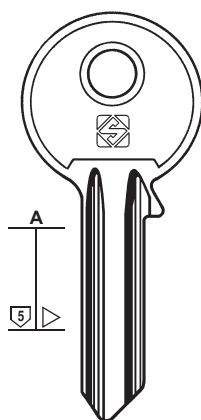

A

5



BS1

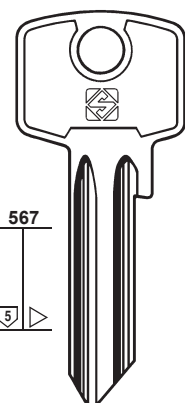

567

5



BS7



BS7R

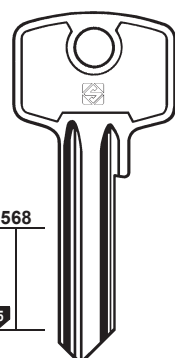

568

5



BS3



BS4R

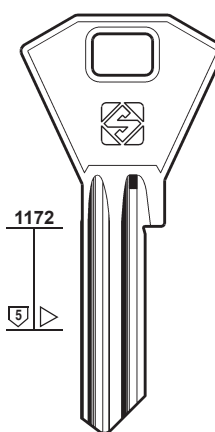

1172

5



BS5



BS5R

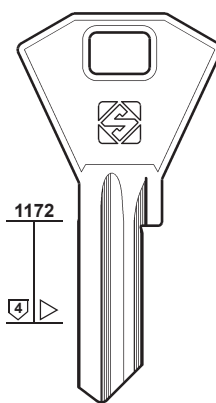

1172

4



BS6R

BANE SEKULIĆ

PER:  
FOR:

### BUGA

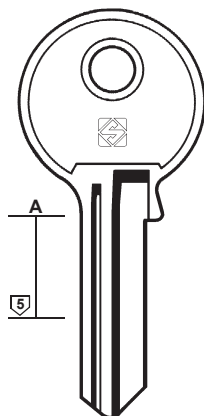

A

5



CS33 CS33R

BASI



mm 50-60

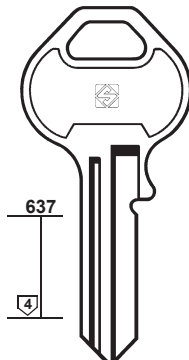

637

4



CS32 CS32R

BASI - CITY



mm 40

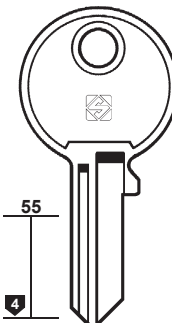

55

4



CS26 CS26R

CITY



mm 30



215

3



CS23 CS23R

BASI - IFAM



mm 20

PER:  
FOR:

# BULAT

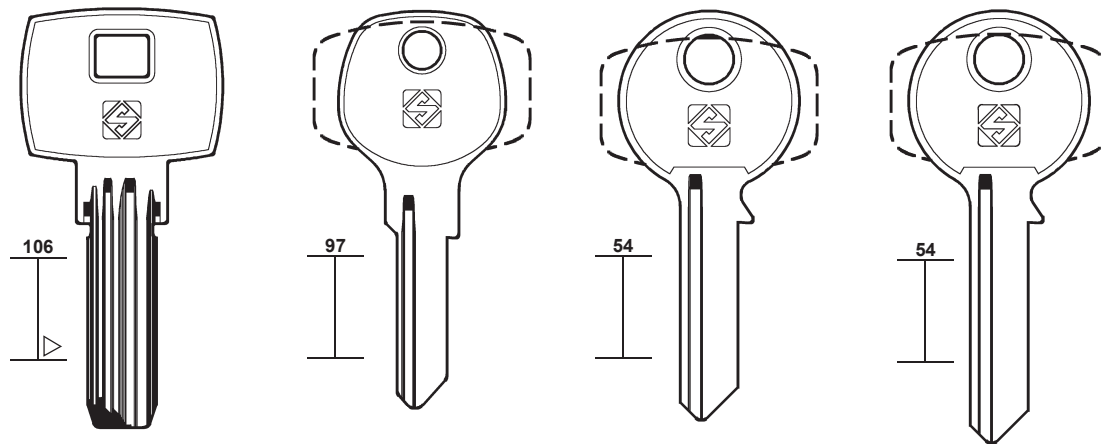

**BUT1R**



**BUT2R**

**BUT3R**

**BUT4R**

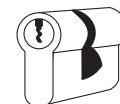

# 41

PER / FOR

**BULAT** (CN)

**BULLDOG** (GB)

**BULLOCK** (IT)

ZADI (220)

**BURAM** (ex YU)

**BURG** (DE)  
MELSMETALL

- + ABUS (8)
- + HOPPE (103)
- + MELSMETALL (136)
- + OJMAR (147)
- + RONIS (162)
- + VIRO (206)
- + ZEISS-IKON (221)

PER:  
FOR:

# BULLDOG

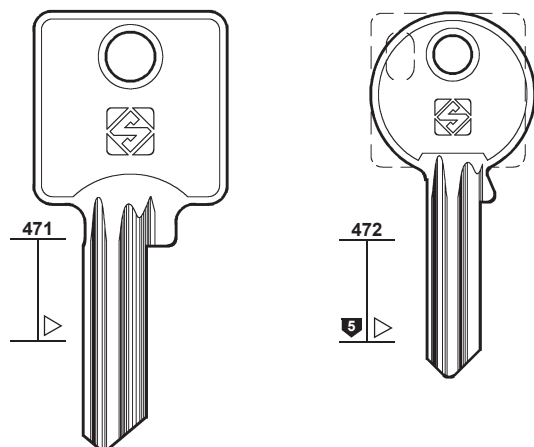

**BLG1**

**BLG2**

# BURAM

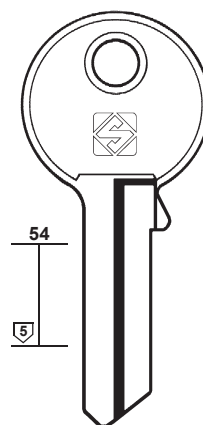

**BU1**

**BU1R**

PER:  
FOR:

# BURG

**BUR1**

19 .....  
20 .....  
21 .....  
23 .....  
27 .....  
29 .....  
31 .....  
33 .....  
49 .....  
769 .....  
799 .....  
0-1-2-3-4-5-6

mm 40-50-60

**BUR8**

19 .....  
20 .....  
22 .....  
24 .....  
28 .....  
30 .....  
32 .....  
34 .....  
799 .....  
0-1-2-3-4-5-6

mm 30-40

**MELSMETALL**

**BUR2**

11 ..... 239 .....  
12 ..... 319 .....  
13 ..... 339 .....  
14 ..... 359 .....  
15 ..... 379 .....  
16 ..... 239 .....  
17 ..... 389 .....  
18 ..... 399 .....  
25 ..... 409 .....  
30 ..... 429 .....  
35 ..... 449 .....  
36 ..... 509 .....  
37 ..... 529 .....  
38 ..... 549 .....  
40 ..... 569 .....  
41 ..... 589 .....  
42 ..... 608 .....  
43 ..... 609 .....  
44 ..... 629 .....  
45 ..... 649 .....  
47 ..... 659 .....  
50 ..... 689 .....  
51 ..... 709 .....  
52 ..... 729 .....  
749 .....  
789 .....  
809 .....  
819 .....  
829 .....

(116/30)

0-1-2-3-4-5-6

0-1-2-3-4-5-6

mm 30-40

**MELSMETALL**

**BUR2R**

11 .....  
12 .....  
26 .....  
46 .....  
309 .....  
329 .....  
349 .....  
369 .....  
389 .....  
419 .....  
439 .....  
459 .....  
519 .....  
539 .....  
559 .....  
579 .....  
599 .....  
619 .....  
639 .....  
669 .....  
679 .....  
699 .....  
719 .....  
739 .....  
759 .....  
839 .....

245

293

**BUR6**

11 .....  
12 .....  
259 .....  
269 .....  
279 .....  
0-1-2-3-4-5-6

mm 25-30

**MELSMETALL**

**BUR1R**

19 .....  
20 .....  
22 .....  
24 .....  
28 .....  
30 .....  
32 .....  
34 .....  
799 .....  
0-1-2-3-4-5-6

mm 30-40

**MELSMETALL**



42

PER / FOR

**BURG** (DE)

- + ABUS (8)
- + HOPPE (103)
- + MELSMETALL (136)
- + OJMAR (147)
- + RONIS (162)
- + VIRO (206)
- + ZEISS-IKON (221)

PER:  
FOR:

### BURG

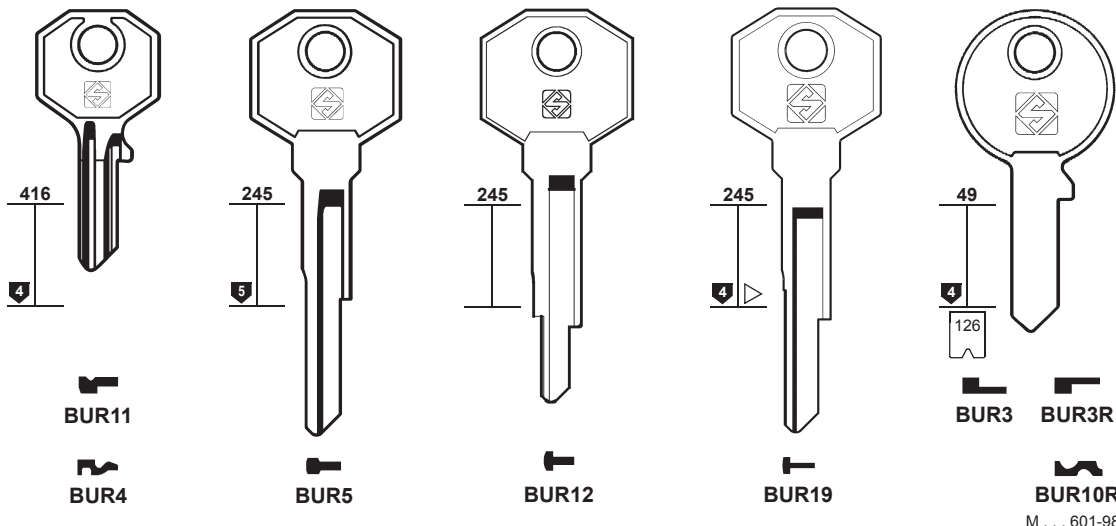

M... 601-983



PER:  
FOR:

### BURG

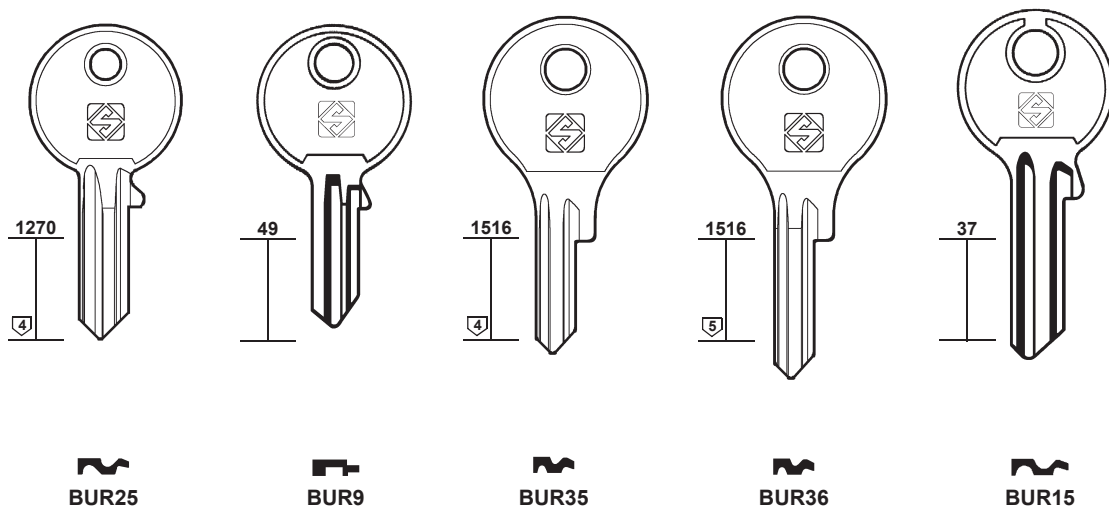

PER:  
FOR:

### BURG

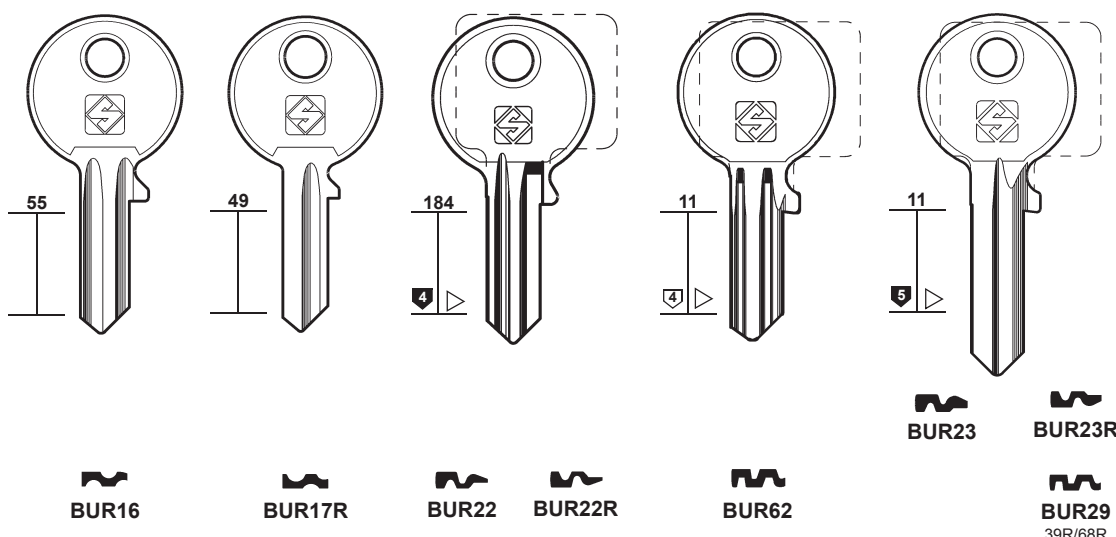

mm 30-35



mm 40

PER:  
FOR:

# BURG

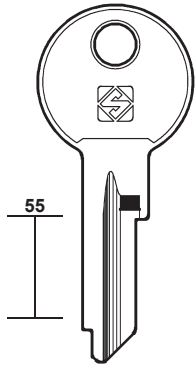

  
**BUR60R**

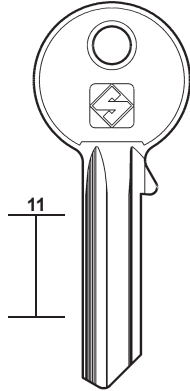

  
**BUR18**

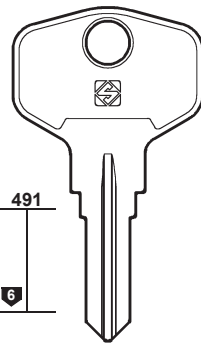

  
**BUR61R**

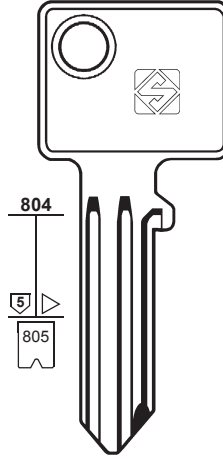







  
**BUR13**  
..... (600/40) 123456  
..... (600/50) 123456  
..... (600/60) 123456



# 43

PER / FOR

- BURG** (DE)  
HOPPE  
OTTO
- +  ABUS (8)
  - +  HOPPE (103)
  - +  MELSMETALL (136)
  - +  OJMAR (147)
  - +  RONIS (162)
  - +  VIRO (206)
  - +  ZEISS-IKON (221)

PER:  
FOR:

# BURG

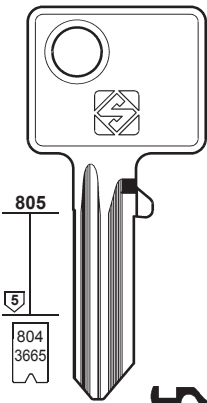



  
**BUR14R**

  
**BUR21**  
..... (116/40)  
..... (116/50)  
..... (116/60)  
..... 123456

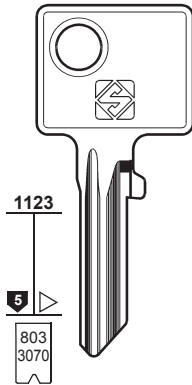

  
**BUR21R**



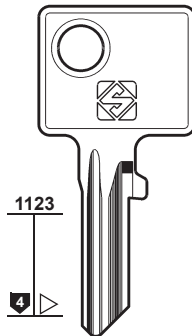

  
**BUR20**  
..... (116/30)  
0-1-2-3-4-5  
..... 1-2-3-4-5-6

  
**BUR20R**

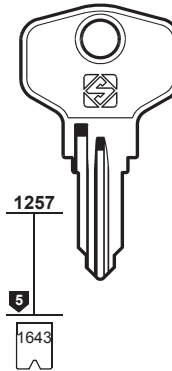

  
**BUR26**



  
**BUR24R**  
2W ... 1-246

HOPPE - OTTO

PER:  
FOR:

# BURG

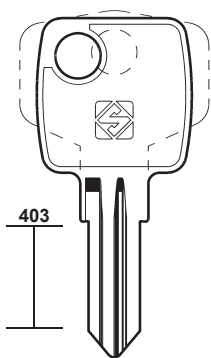

  
**BUR28R**  
34W

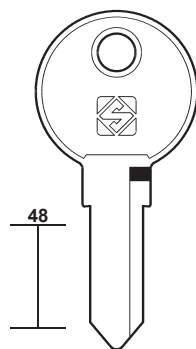

  
**BUR31**   **BUR31R**

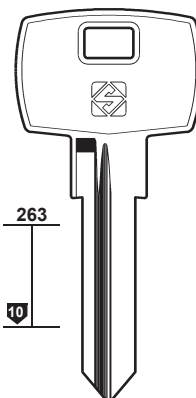

  
**BUR32**  
26W

  
**BUR34R**

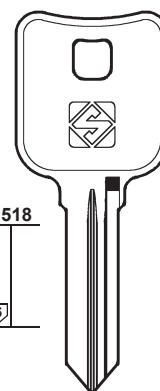

  
**BUR38**





44

PER / FOR

**BURG** (DE)

- + ABUS (8)
- + HOPPE (103)
- + MELSMETALL (136)
- + OJMAR (147)
- + RONIS (162)
- + VIRO (206)
- + ZEISS-IKON (221)

**BUS** (DE)  
KROST

**BUVA** (DE)

- GERA
- KALE
- + PHAFFENHAIN (155)

**BV** (DE)

- + CAS-CISMA (45)
- + FASEM (86)

**BWS** (GB)

- + CORBIN (60)

**CAB** (IT)

- + CAS-CISMA (45)
- + SIMECA (170)
- + YALE (213)

**CAF** (IT)

**CAM** (FR)

- + ISEO (108)

PER:  
FOR:

**BURG**

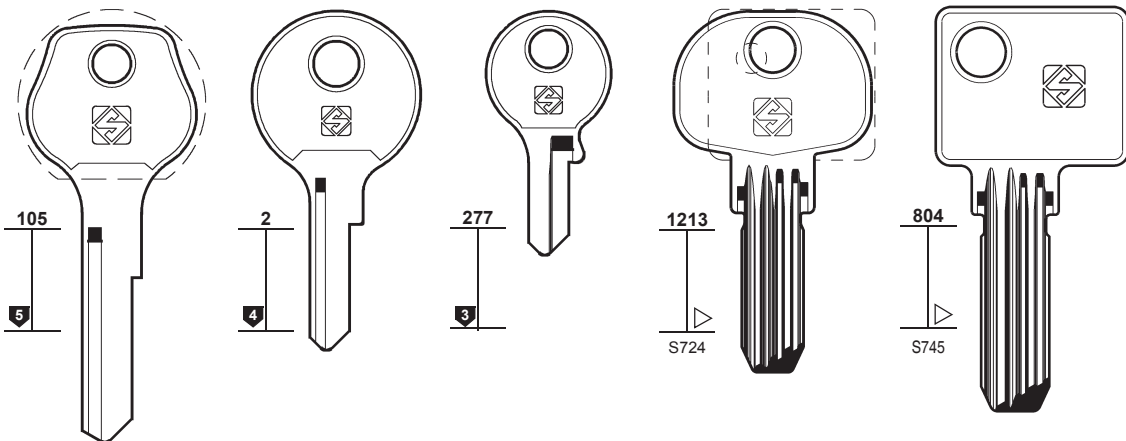

**BUR57R**  
71R

**BUR55R**  
77R

**BUR56**  
405/20

**BUR27**  
75W

**BUR33**  
76W



PER:  
FOR:

**BUS**

**BUVA**

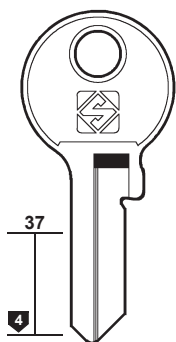

**BUS1**

KROST

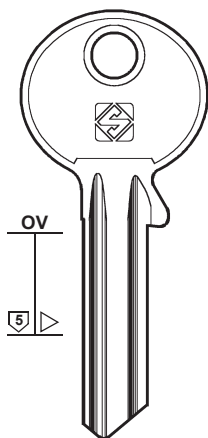

**BVA1**

**BVA1R**

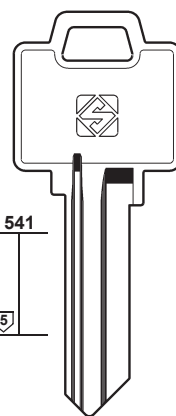

**BVA3**

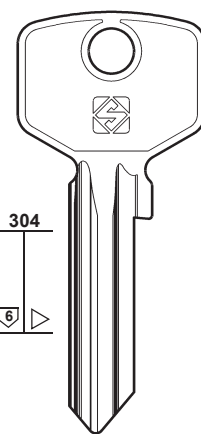

**BVA4**

GERA - KALE

PER:  
FOR:

**CAB**

**CAF**

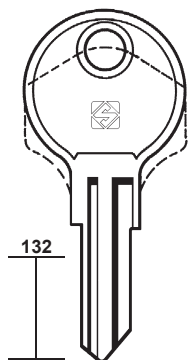

**CAB1**

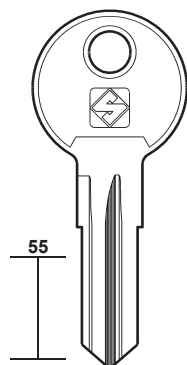

**CAB2R**

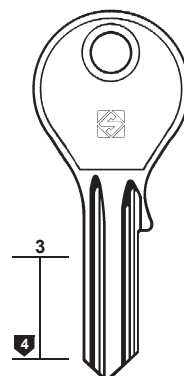

**CAF1**

**CAF1R**

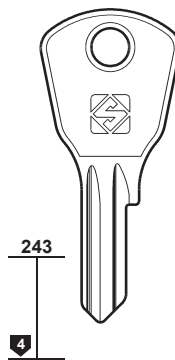

**CAF2**

**CAF2R**



PER:  
FOR:

### CANDAVEN CV

### CARACAL

### CARL F

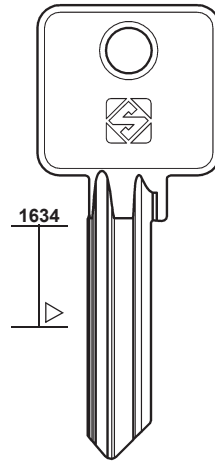
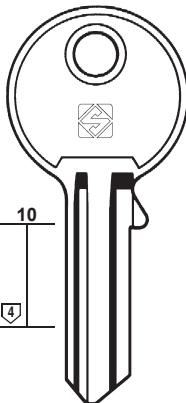
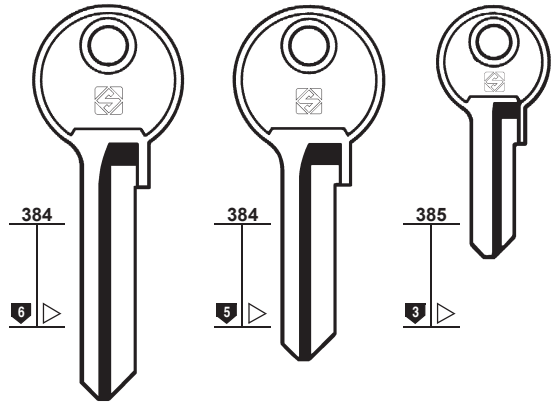

CV1



CV2



CV3



CAR1



CLF2



# 45

PER / FOR

#### CANDAVEN CV (VE)

##### CAP (FR)

- CITY (58)
- KVR (119)
- PREFER (157)
- VACHETTE (201)

#### CARACAL (TW)

##### CARAT (DE)

- YALE (212)

#### CARL F (GB)

##### CAROLI (IT)

- MERONI (136)

##### C.A.R.S. (IT)

- OMA (148)

##### CASAS (ES)

- AGA (11)

#### CAS-CISMA (IT)

- BV
- CAB
- DOMUS
- ETNA
- FTH
- GSA
- GUARDIAN
- LAPERCHÉ
- M
- MERONI
- MST
- SISO
- SOBINCO
- STIQAM
- STREMLER
- TECHNAL
- TESTA

PER:  
FOR:

### CAS-CISMA

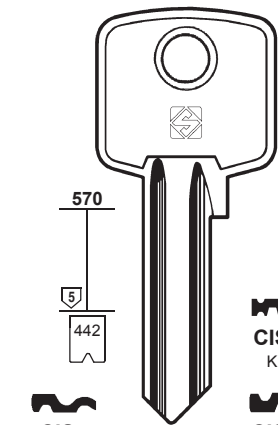

CIS5

- ..... 1234567
- ..... 123456789AB
- L..... 1001-2178
- L..... 14001-14500
- L..... 15001-18199
- ..... 20001-20625

ETNA - FTH - GSA - LAPERCHÉ  
STREMLER - TECHNICAL

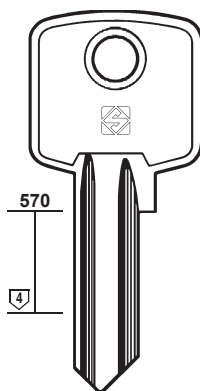

CIS11  
KRL



CIS5R



CIS8

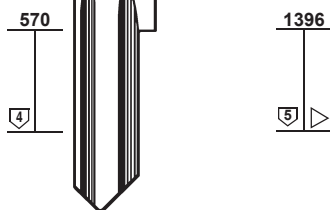

CIS6



CIS6R

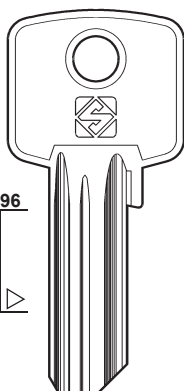

CIS9

- ..... 12345678AB
- ..... 12345678



CIS12

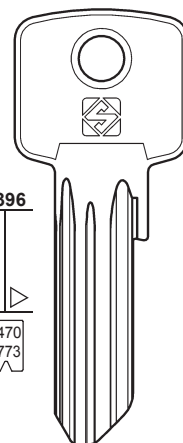

CIS12X

- ..... 12345678



MERONI - SOBINCO

PER:  
FOR:

### CAS-CISMA

### CASH-BOX

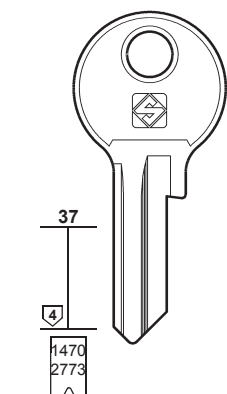

CIS7

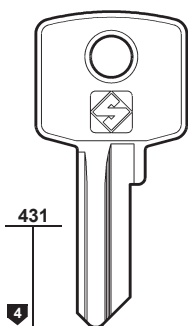

CIS4



CIS2



CIS4R

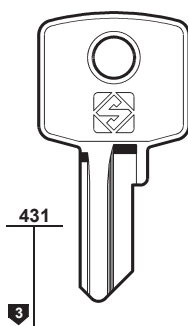

CIS1



CIS3



BV - CAB - DOMUS - GUARDIAN  
M - MST - SISO - STIQAM - TESTA

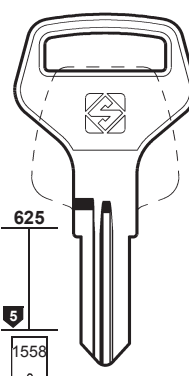

CAX1R

- ... 101-170
- ... 201-270

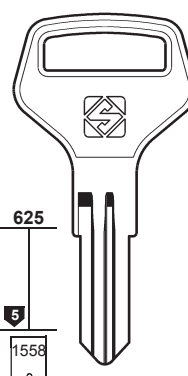

CAX2R

- ..... 0-1-2
- ..... 301-370



##### CASI (DE)

- SCHLECHTENDAHL (166)

##### CASIO (IT)

- OLIVETTI (148)

#### CASH-BOX (DE)

- + CLAUSOR (59)
- + KIFERM (117)

##### CASMA (IT)

- CES (48)
- P.C. (154)

##### CATOR (FR)

- RONIS (161)

##### CAVERS (FR)

- AZBE (27)
- CISA (55)
- CITY (58)
- SPIDER (174)



46

PER / FOR

CAYS (ES)

CCC (IL)

CDP (NL)

CEE (PT)

CCL (FR)

CORBIN (62)

CEKA (DE)

HUWIL (104)

CEMA (IT)

ELFIN

LAMPA

CENTURY (GB)

ALLGOOD

PER: FOR:	CAYS	CCC	CDP
	 10  626 mm 27 0-1-2-3-4-5-6-7-8-9  <b>CYS1</b>  <b>CYS1R</b>  <b>CYS2</b>	 431  4 <b>CCC1</b> <b>CCC1R</b>	 214  5 <b>CDP1R</b>

PER: FOR:	CEE	CEMA	CENTURY	
	 A  4 <b>CEE1</b>	 73  4 552 <b>CM3</b> E.. 1-78 <b>CM4</b> G.. 1-78 <b>CM2</b> <b>CM1</b>  <b>ELFIN - LAMPA</b>	 73  5 <b>GT4</b> <b>GT4R</b> <b>CM3R</b> F.. 1-78 <b>CM4R</b> H.. 1-78 <b>CM2R</b> <b>CM1R</b>  <b>ELFIN - LAMPA</b>	 185  5 <b>CEN4R</b>

PER: FOR:	CENTURY			
	 182  5 <b>CEN1</b> <b>CEN1R</b>	 N  5 <b>CEN2</b> <b>CEN2R</b>	 171  <b>CEN3</b>	 577  5  ø 7.5 ø 10 <b>CEN5T</b>



PER:  
FOR:

### CES

**CE147**  
mm 27,5  
7  
CE6  
ELZETT  
FRECOV  
HÄFELE  
HANNO  
JOSTA  
KARDEX  
KIND  
KNAPP  
MAUSER  
NEMEF  
OJMAR  
VOKO  
WASO  
WECO

**CE4**  
69  
6  
223  
414  
mm 23  
CE4R  
BODA  
ELZETT  
FRECOV  
KNAPP

**CE8**  
69  
6  
223  
1544  
2320  
mm 23  
CE8  
..... 12345678

**CE7**  
69  
5  
mm 21  
CE7R  
BODA  
FRECOV  
KNAPP  
OJMAR

**CE18**  
69  
4  
223  
1594  
mm 18  
CE18R  
N .. 1-50  
... 101-400

**CE9**  
..... 12345678  
CE9  
FRECOV  
HÄFELE  
HANNO  
JOSTA  
KARDEX  
KIND  
KNAPP  
MAUSER  
NEMEF  
OJMAR  
SÄNTIS  
VOKO  
WASO  
WECO

**CE34**  
..... 123456789  
CE35  
..... 123456789  
CE36  
..... 123456789

**CE10**  
CE10  
WS ... 401-410

**CE21R**  
WS ... 401-410

**CE29R**

**STUV**



# 47

PER / FOR

**CES (DE)**  
BERRY  
BODA  
BOTT  
COMBA  
ELZETT  
FEFI  
FRECOV  
FUHR  
GIESCHE  
HÄFELE  
HANNO  
HÖHRMANN  
JOSTA  
KARDEX  
KIMA  
KIND  
KNAPP  
MAUSER  
MBB  
NEMEF  
OJMAR  
OTIS  
SÄNTIS  
SIEBAU  
SOLID  
SS  
STUV  
TORE  
TRITON  
VOKO  
WASO  
WECO

PER:  
FOR:

### CES

**CE33**  
295  
4  
mm 18,5

**CE13**  
37  
3  
mm 15,5  
CE13R  
BODA  
ELZETT  
FRECOV  
KNAPP

**CE11**  
2  
CE11R  
BOTT

**CE19**  
385  
mm 15  
CE19R

**CE30**  
215  
3  
CE30R

**STUV**

PER:  
FOR:

### CES

**CE3**  
68  
6  
643  
mm 33  
.....  
1-2-3-4-5-6-7-8-9-0  
BODA

**CE1**  
OV  
6  
357  
557  
mm 31,5  
CE1  
FUHR  
GIESCHE  
HÖHRMANN  
KIMA  
NEMEF  
SIEBAU  
SOLID  
SS  
STUV  
.....  
1-2-3-4-5-6-7-8-9-0  
A .....  
1-2-3-4-5-6-7-8

**CE5**  
OV  
5  
357  
mm 28

**CE2**  
OV  
5  
357  
557  
mm 28  
.....  
1-2-3-4-5-6-7-8-9-0  
BB ..... 1-12000  
BBF ..... 1-12000  
BT ..... 1-12000  
TS ..... 1-12000  
CE2R  
SOLID  
TORE

**CE2X**



48

PER / FOR

CES (DE)  
CASMA  
HÄFELE  
NEMEF  
SPEEDAL

PER:  
FOR:

CES

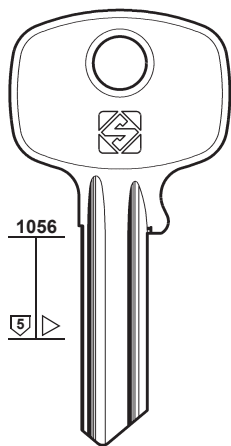

CE40

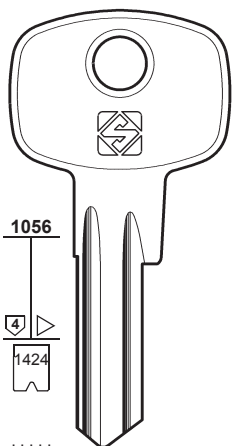

CE41

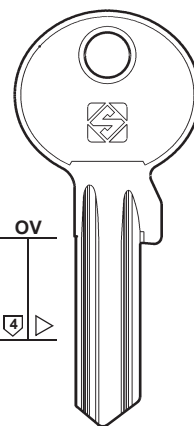

CE41X-OV

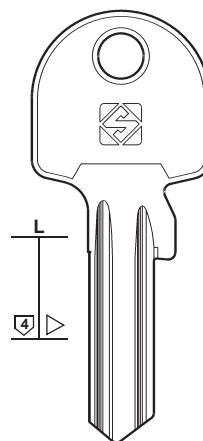

CE41XL

HÄFELE

PER:  
FOR:

CES

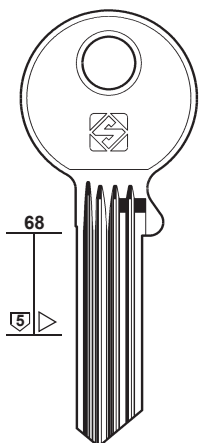

CE17XPS

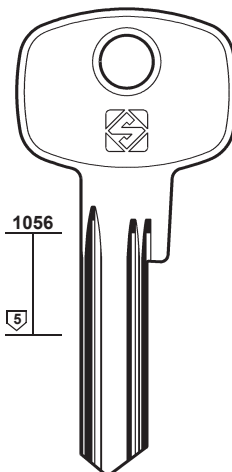

CE127

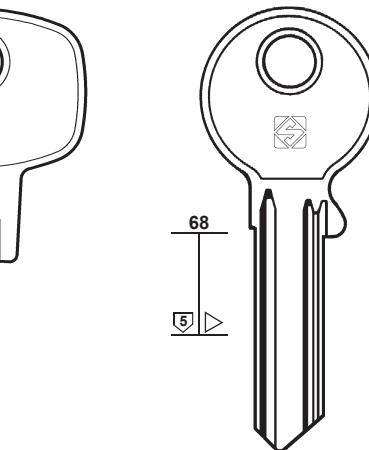

CE155

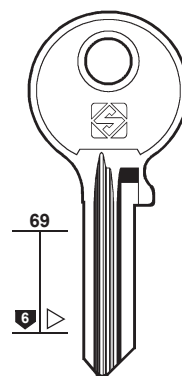

CE153R

CE17WPS

CE150

NEMEF

CE154

CE20

CE114

NEMEF

PER:  
FOR:

CES

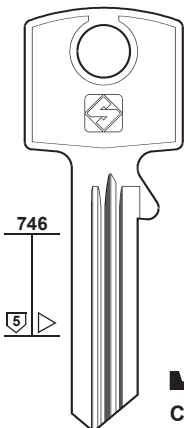

CE23R

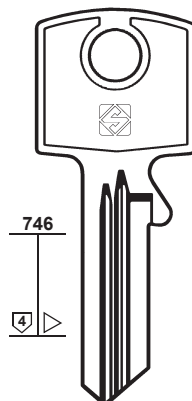

CE27

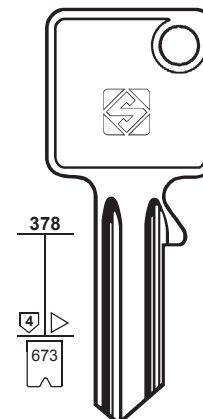

CE12  
..... 1234567890

CE28

CE24R

CE25R

CE31

CE32R

CE26R

CASMA - SPEEDAL

PER:  
FOR:

### CES



# 49

PER / FOR

CES (DE)  
BODA

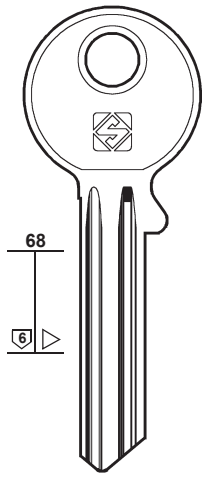

**CE149**

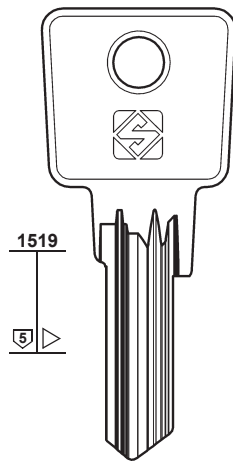

**CE158**

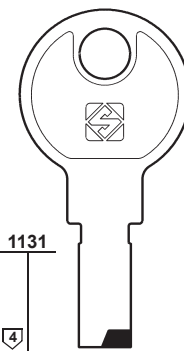

S914  
MS...1-20

**CE131**



PER:  
FOR:

### CES

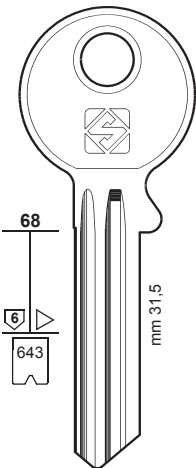

**K CE15**   **CE39**  
**TB CE16**

- |                   |                   |
|-------------------|-------------------|
| 15 <b>CE14-15</b> | 35 <b>CE14-35</b> |
| 16 <b>CE14-16</b> | 36 <b>CE14-36</b> |
| 17 <b>CE14-17</b> | 37 <b>CE14-37</b> |
| 18 <b>CE14-18</b> | 38 <b>CE14-38</b> |
| 25 <b>CE14-25</b> | 45 <b>CE14-45</b> |
| .....1234567890   |                   |
| 26 <b>CE14-26</b> | 46 <b>CE14-46</b> |
| 27 <b>CE14-27</b> | 47 <b>CE14-47</b> |
| 28 <b>CE14-28</b> | 48 <b>CE14-48</b> |

BODA

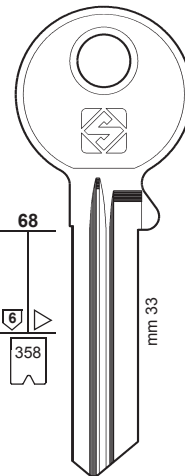

- |                   |                   |
|-------------------|-------------------|
| 15 <b>CE22-15</b> | 35 <b>CE22-35</b> |
| 16 <b>CE22-16</b> | 36 <b>CE22-36</b> |
| 1Z.....1-100000   |                   |
| 17 <b>CE22-17</b> | 37 <b>CE22-37</b> |
| 18 <b>CE22-18</b> | 38 <b>CE22-38</b> |
| 25 <b>CE22-25</b> | 45 <b>CE22-45</b> |
| 26 <b>CE22-26</b> | 46 <b>CE22-46</b> |
| 27 <b>CE22-27</b> | 47 <b>CE22-47</b> |
| 28 <b>CE22-28</b> | 48 <b>CE22-48</b> |

BODA

PER:  
FOR:

### CES

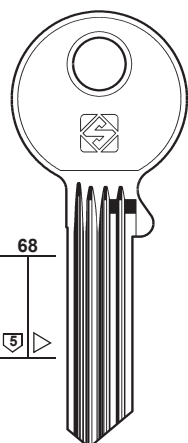

- |                |                |                |                |                |                |
|----------------|----------------|----------------|----------------|----------------|----------------|
| <b>CE17W23</b> | <b>CE17W30</b> | <b>CE17W37</b> | <b>CE17X23</b> | <b>CE17X30</b> | <b>CE17X37</b> |
| <b>CE17W24</b> | <b>CE17W31</b> | <b>CE17W38</b> | <b>CE17X24</b> | <b>CE17X31</b> | <b>CE17X38</b> |
| <b>CE17W25</b> | <b>CE17W32</b> | <b>CE17W39</b> | <b>CE17X25</b> | <b>CE17X32</b> | <b>CE17X39</b> |
| <b>CE17W26</b> | <b>CE17W33</b> | <b>CE17W40</b> | <b>CE17X26</b> | <b>CE17X33</b> | <b>CE17X40</b> |
| <b>CE17W27</b> | <b>CE17W34</b> | <b>CE17W41</b> | <b>CE17X27</b> | <b>CE17X34</b> | <b>CE17X41</b> |
| <b>CE17W28</b> | <b>CE17W35</b> | <b>CE17W42</b> | <b>CE17X28</b> | <b>CE17X35</b> | <b>CE17X42</b> |
| <b>CE17W29</b> | <b>CE17W36</b> |                | <b>CE17X29</b> | <b>CE17X36</b> |                |



50

PER / FOR

CES (DE)  
BODA  
THÖMEE

PER:  
FOR:

CES

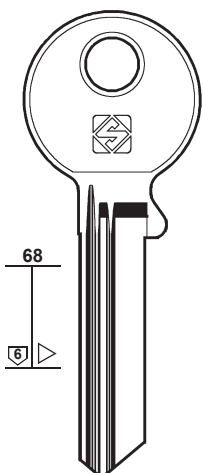

PER:  
FOR:

CES

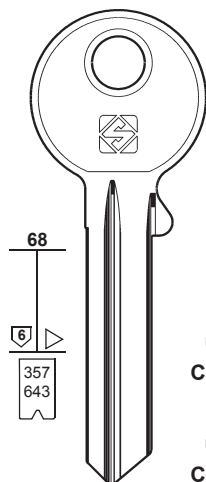

.....  
1-2-3-4-5-6-7-8-9-0



BODA - THÖMEE

PER:  
FOR:

# CES

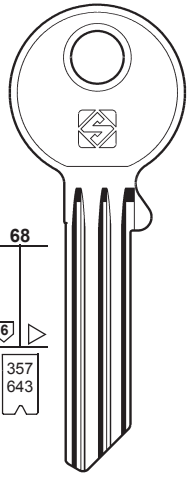

 CE130-1 C/2	 CE130-2 B/2	 CE130-3 B/1	 CE130-4 C/4	 CE130-5 A/4	 CE130-6 A/5	 CE130-7 C/5
 CE130-8 C/1	 CE130-9 A/2	 CE130-10 D/1	 CE130-11 A/34	 CE130-12 B/3	 CE130-13 X/678	 CE130-14 1/68
 CE130-15 4/67	 CE130-16 4/68	 CE130-17 AB5	 CE130-18 B/15	 CE130-19 C/15	 CE130-20 AD1	 CE130-21 AD4
 CE130-22 A1-5	 CE130-23 AB1-3	 CE130-24 D1-5	 CE130-25 D/2	 CE130-26 D/5	 CE130-27 D/4	 CE130-28 A/3
 CE130-29 C/34	 CE130-30 C/3	 CE130-31 B/34	 CE130-32 B/5	 CE130-33 B/4	 CE130-34 D/3	 CE130-35 A/1

1-2-3-4-5-6-7-8-9-0

BODA - THÖMEE



# 51

PER / FOR

**CES** (DE)  
BODA  
THÖMEE

**CEV** (IT)  
IDRO-STOP (105)

**CF** (FR)  
FTH (91)

**CFP** (DE)  
WILKA (210)

**CHANGE-O-MATIC** (FR)  
CORBIN (62)

**CHAVO** (PT)  
+ CISA (55)  
+ SOFI-SONAFI (172)

**CHEK** (HK)  
CHEYLOCK

**CHELIABINSK** (RU)

**CHEYLOCK** (HK)  
CHEK (51)

**CHG** (FR)  
GABON (93)

**CHICAGO** (US)  
FORT  
ILLINOIS  
ODA

PER:  
FOR:

## CHAVO

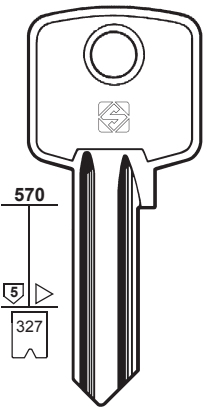

CHV1 CHV1R

## CHEK

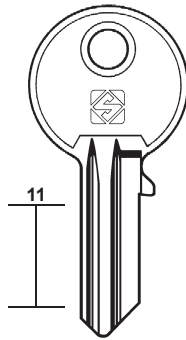

CK1  
CHEYLOCK

## CHELIABINSK

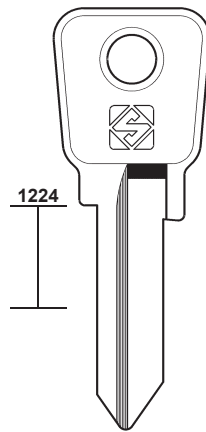

CLK1

## CHICAGO

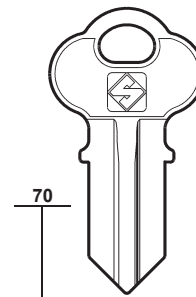

CH1 CH2  
CH3 CH4  
CH5 CH8

PER:  
FOR:

## CHICAGO

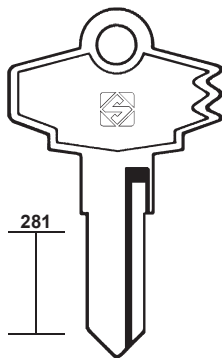

CH6

ILLINOIS - ODA

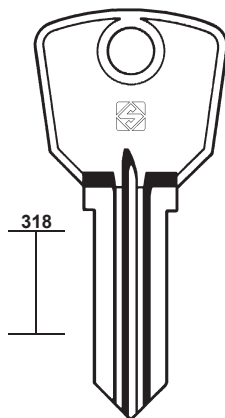

CH7 CH7R

FORT

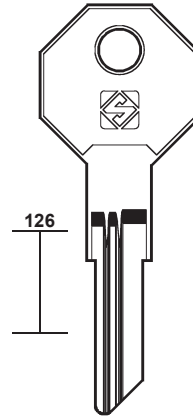

CH15

ODA



52

PER / FOR

**CHICAGO (US)**

- ACE
- ADEMCO
- AGA
- ALPHA
- EURO LOCKS
- FORT
- GEM
- IFAM
- L & F
- STEELCASE

**CHRIST (DE)**

- DOM (68)
- HUWIL (104)

**CHSS (TW)**

**CHUBB (GB)**

- AVA-CHUBB (26)

**CIAL (BR)**

**CIB (FR)**

- FTH (90)
- OMIV (149)
- PREFER (157)
- UCEM (192)

**CIBC (IT)**

- CISA (57)
- FTH (90)

**CIC (IT)**

- BASI (31)
- CORNI (62)

PER:  
FOR:

**CHICAGO**

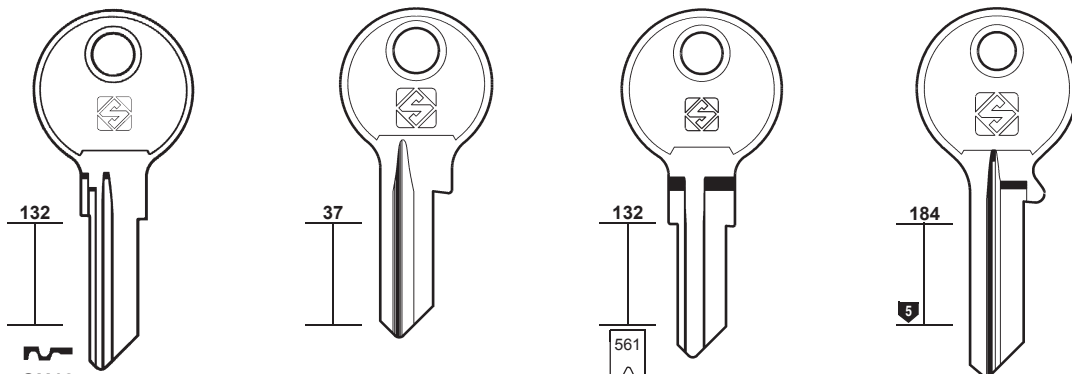

CH18

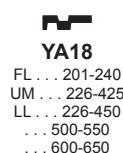

STEELCASE

PER:  
FOR:

**CHICAGO**

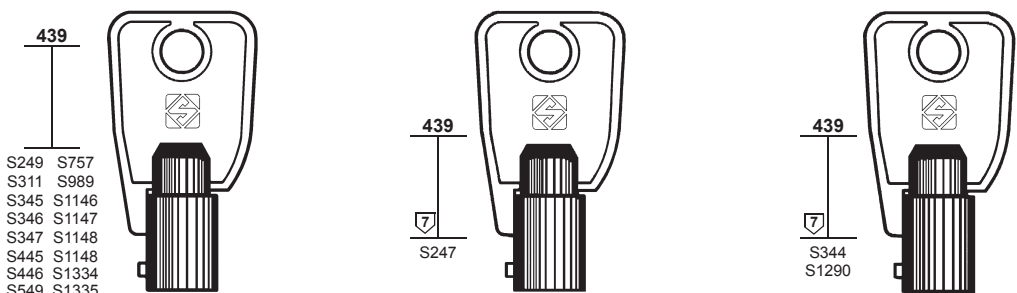

- S249 S757
- S311 S989
- S345 S1146
- S346 S1147
- S347 S1148
- S445 S1148
- S446 S1334
- S549 S1335
- S550

- S247

- S344
- S1290

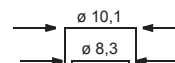
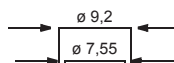
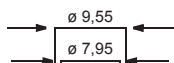

- ... 1-999
- ... 2001-2100
- ... 0123
- ... 7654321
- ... 7654321
- ... 7654321
- ... 1234567
- ... 280001-285000
- ... 320001-326000
- ... 24568ABCDEFGHIJKLMNO

- ... HD 0001-9400
- ... HD ... 0001-9400
- ... HMC ... 00001-31000

- ... 7-6-5-4-3-2-1

- ... 123456
- ... X123456

ACE - ADEMCO - AGA - ALPHA  
EURO LOCKS - FORT  
GEM - IFAM - L & F

PER:  
FOR:

**CHSS**

**CHUBB**

**CIAL**

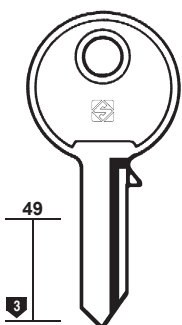

CHS1

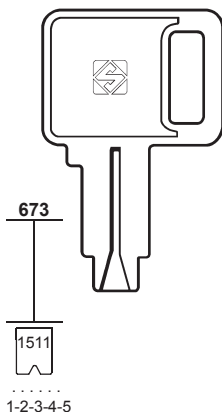

CHU5

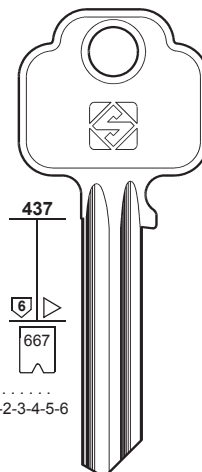

CHU6

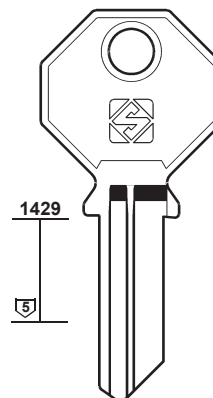

CIA1

PER:  
FOR:

### CIEF

### CIELS



# 53

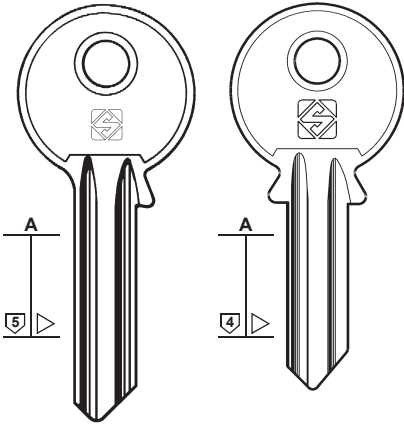

FEB2 FEB2R FEB1 FEB1R

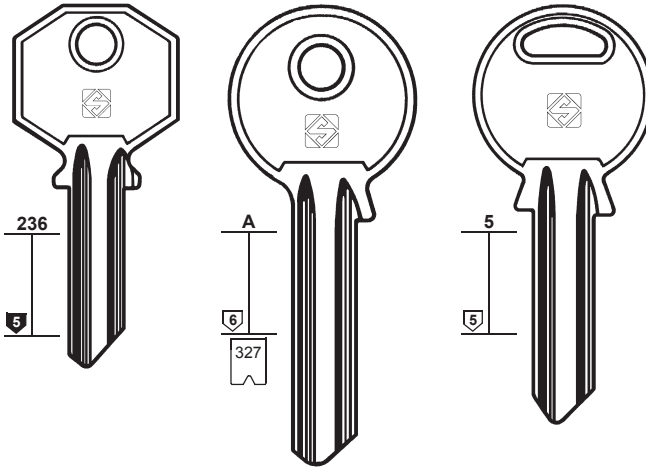

CLS1 CLS242 CLS3 CLS220 CLS2

1-2-3-4-5-6



### PER: FOR: CIERRA SOLA

### CIFIAL

### CIL LIL

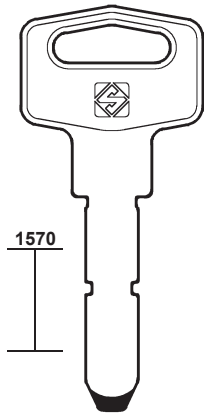

CRL1

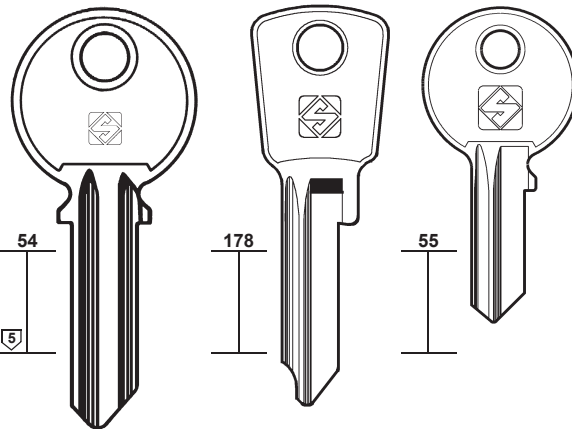

CF1 CF1R  
CF2 CF2R

CF3

CF4

LE FEBURE

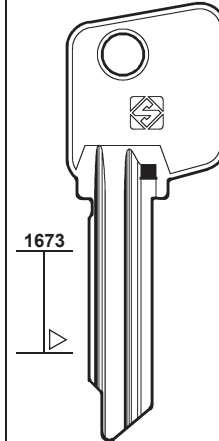

CL11

PER:  
FOR:

### CILA-GENTILI

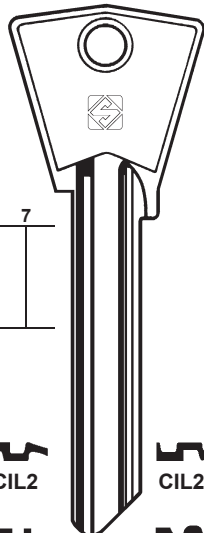

CIL2

CIL2R

CIL4

CIL6

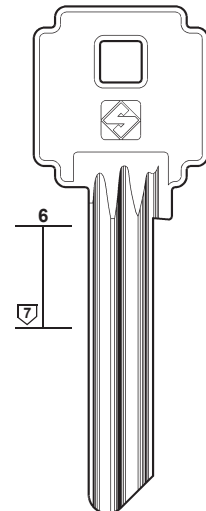

CIL7

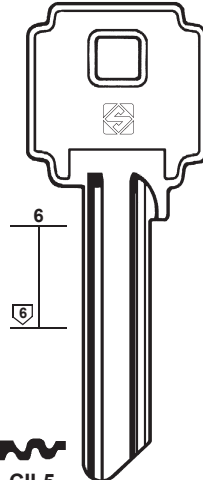

CIL5

CIL1

CIL1R

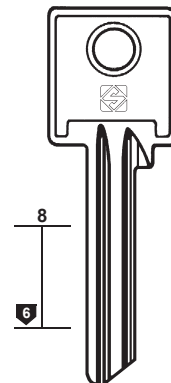

CIL3



PER / FOR

CIEF (FR)

CIELS (IT)

CIERRA SOLA (AR)

CIFIAL (PT)  
LE FEBURE

CIGNO (IT)  
CISA (57)

CIL LIL (IL)

CILA-GENTILI (IT)



54

PER / FOR

CINA (TW)

555  
ABUS  
ALI  
BAODEAN  
EIKO  
HOOPLY  
MASTER LOCK  
MSM  
SHANGHAI  
+ SHANGHAI (168)

PER:  
FOR:

CINA

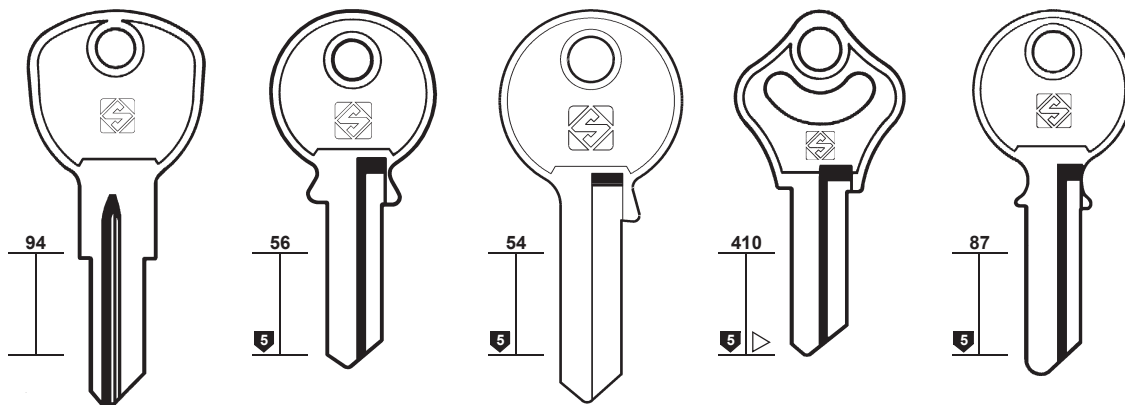

RC1R



A303



C303



AS1



mm 45



SG808



SG808R



SHANGHAI



SG1



SHANGHAI

PER:  
FOR:

CINA

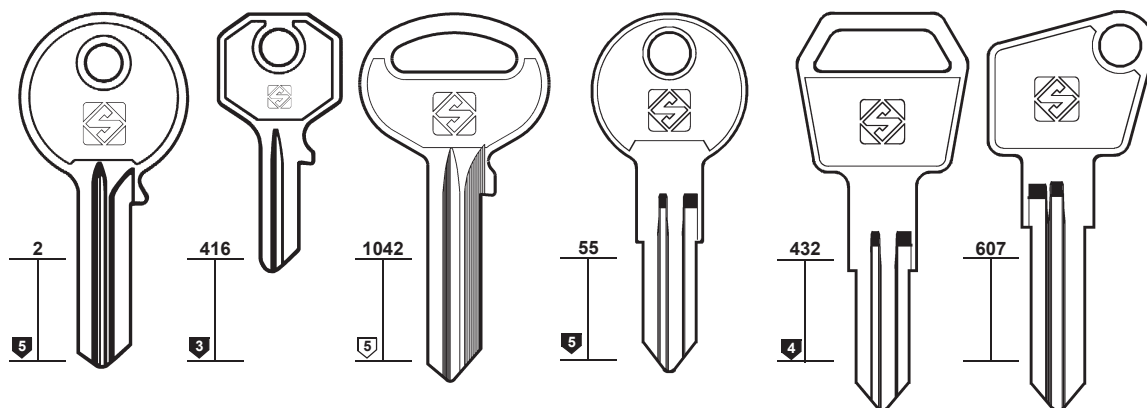

454



C555



555



RC3R

ALI - EIKO



RC4



RC5



RC5R



RC6



RC6R



RC7R



PER:  
FOR:

CINA

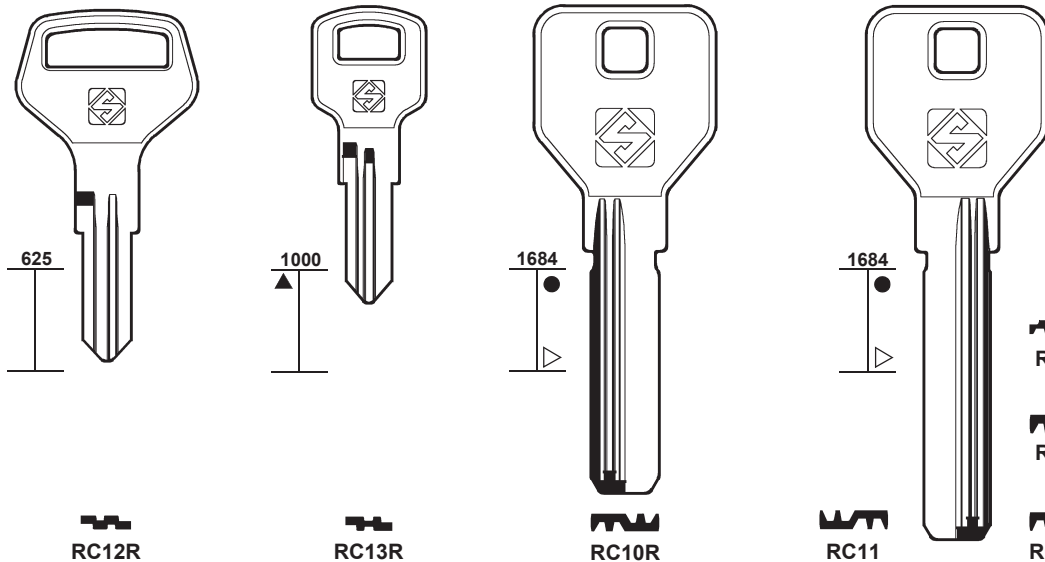

RC12R



RC13R



RC10R



RC11



RC9R



RC8R



RC11R



BAODEAN - HOOPLY  
MASTER LOCK - MSM



PER:  
FOR:

# CINA

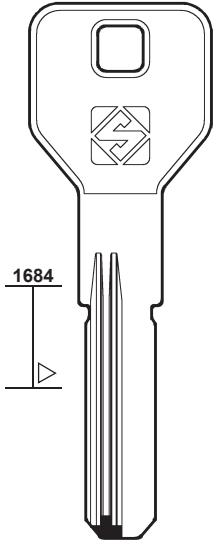

1684

**RC15R**

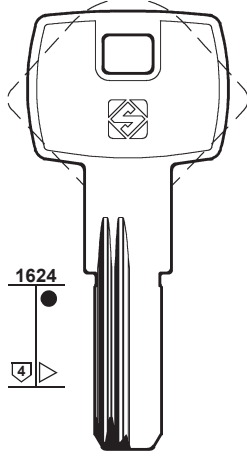

1624

**RC16R**

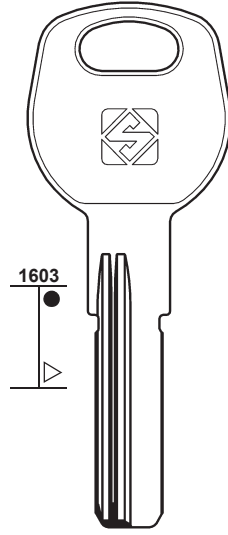

1603

**RC17R**

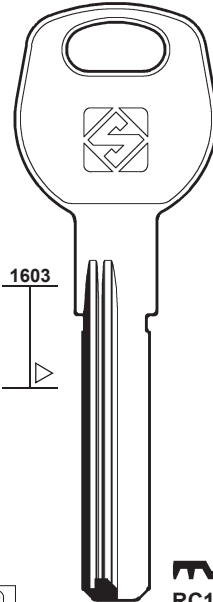

1603

**RC14R**



# 55

PER / FOR

**CINA** (TW)  
+ SHANGHAI (168)

**CISA** (IT)  
ABUS  
ALA  
ALF  
BRICARD  
CAVERS  
CHAVO  
DOBUS  
ESCO  
ESSENDIA  
GEFI  
GETE  
GEVY  
GTV  
ITO  
LOGO  
NB  
SCHÜCO  
STANDARD  
TIEFENTHAL  
TZAFRER  
UNIFERRO  
+ ABUS (6-7-8-10)  
+ ALA (14)

PER:  
FOR:

# CISA

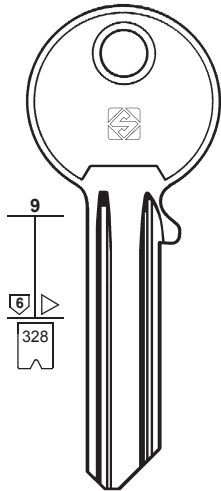

9

6

328

**CS501R**

**CS501**

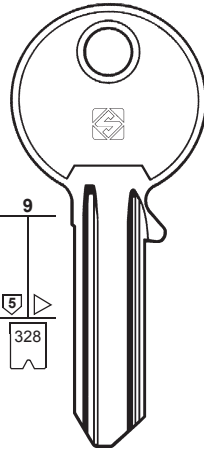

9

5

328

**CS500R**

**CS500**

..... 1-2-3-4-5

..... 1-2-3-4-5

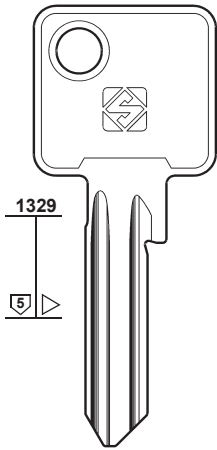

1329

5

**CS85**

**CS17 CS17R**  
mm 50-55-60-65  
70-75-77-84-94  
ALA

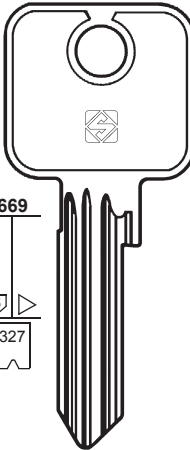

669

5

327

**CS47**

**CS47R**

..... 1-2-3-4-5-6

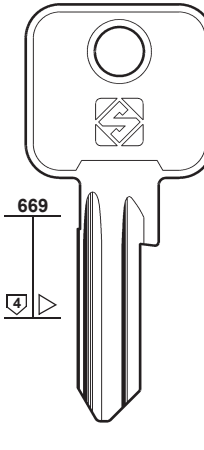

669

4

**CS46**

**CS46R**

PER:  
FOR:

# CISA

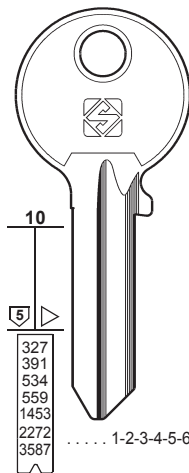

10

5

327

391

534

559

1453

2272

3587

AY ..... 1-6032  
BA ..... 1-6032  
BB ..... 1-6032  
BC ..... 1-6032  
BD ..... 1-6032  
BJ ..... 1-6032  
BK ..... 1-6032  
BL ..... 1-6032  
BM ..... 1-6032  
BN ..... 1-6032  
BP ..... 1-6032  
BQ ..... 1-6032  
BR ..... 1-6032  
BS ..... 1-6032  
BT ..... 1-6032  
BU ..... 1-6032  
BY ..... 1-6032  
SA ..... 1-6032  
SB ..... 1-6032  
..... 123456  
..... 123456789

**CS206**

**CS13**  
 **BRICARD**

**CS13R**  
 **BRICARD**

**CS14**  
 **CS14R**

**CS15**  
 **CS15R**

**CS15R**  
 **CS162**

**CS18**  
 **LOGO**

**CS18R**  
 **LOGO**

**CS68**

**CS24**  
 **LOGO**

**CS24R**  
 **LOGO**

**CS88**

**CS31**  
 **CS31R**

**CS31R**  
 **CS138**

**CS138**  
G08D

**CS38**  
 **CS38R**

**CS38R**  
 **CS142**

**CS142**

**CS44**  
 **CS44R**

**CS44R**  
 **CS143**

**CS143**

**CS49**  
G28D

**CS50**  
G16D

**CS147**

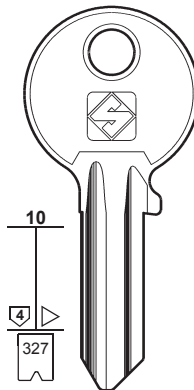

10

4

327

327

391

534

559

1453

2272

3587

**CS204**

**CS205**

..... 1-2-3-4-5-6

**CS16**  
 **LOGO**

**CS16R**  
 **LOGO**

..... 1-2-3-4-5-6

**CS25**  
 **LOGO**

**CS25R**  
 **LOGO**

**CS30**

**CS30R**

**CS34**

**CS34R**

**CS36**

**CS41**

**CS37**

**CS37R**

**CS42**  
G28D

**CS43**  
G16D

**CS105**

**CS67**

**DOBUS - GEVY - TZAFRER**

**mm 50-60**

..... 1-2-3-4-5-6  
E ..... 1234567890ABCDEFGHIJ



56

PER / FOR

CISA (IT)

ABUS

BRICARD

ESLA

JPM

+ ABUS (6-7-8-10)

+ ALA (14)

PER:  
FOR:

CISA

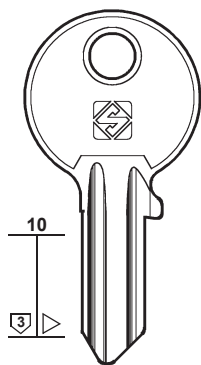

10  
3

CS66

CS4

CS4R

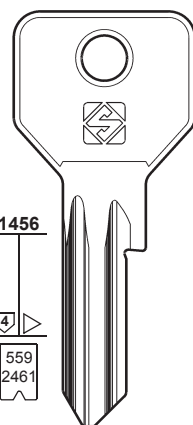

1456  
4  
559  
2461

CS120

CS120R

..... 1-2-3-4-5-6-7-8  
..... (C 2000) 1-2-3-4-5-6-7-8

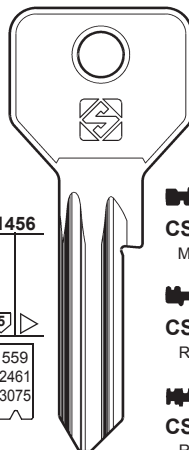

1456  
5  
559  
2461  
3075

CS170  
M080

CS168  
R035

CS152  
R027

CS119

CS119R

..... 0-1-2-3-4-5-6-7-8  
..... 1-2-3-4-5-6-7-8  
..... (C 2000) 1-2-3-4-5-6-7-8

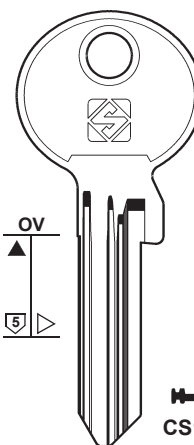

OV  
5

CS163X  
ABUS

CS13X  
BRICARD

CS52X  
G14D



PER:  
FOR:

CISA

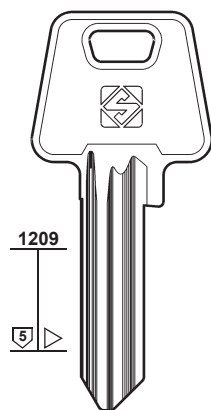

1209  
5

CS61

JPM

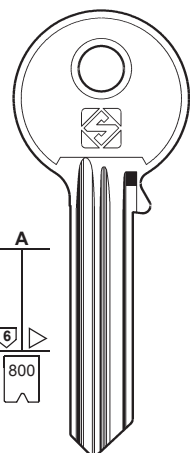

A  
6  
800

CS121

..... 0-1-2-3-4-5-6-7-8-9

ESLA

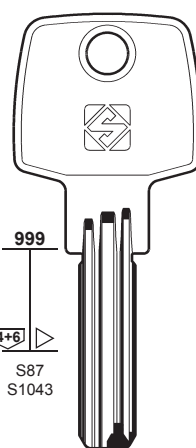

999  
4+6  
S87  
S1043

CS48

A/Z A/Z A/Z .....  
000001-030198



ABUS  
BRICARD

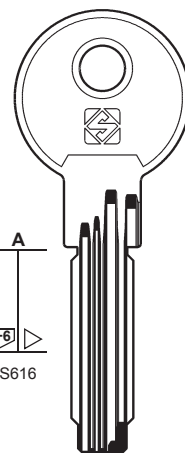

A  
6+6  
S616

CS70 W60

..... AM 1-38832 AM



ASIX

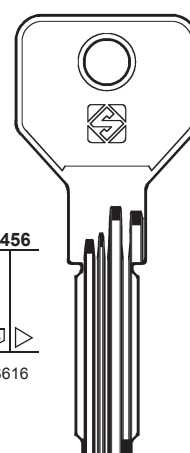

1456  
6+6  
S616

CS146

..... AM 1-38832 AM



ASIX

PER:  
FOR:

CISA

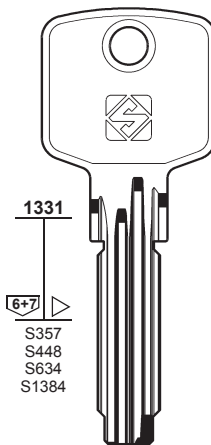

1331  
6+7  
S357  
S448  
S634  
S1384

CS144

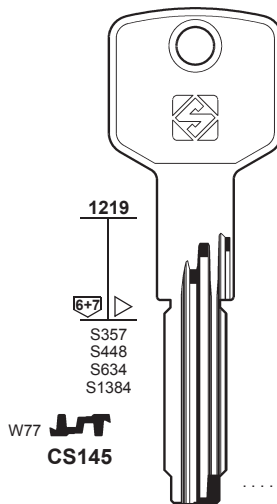

1219  
6+7  
S357  
S448  
S634  
S1384

W77 CS145

W76 CS139

..... (XN008710) 1-11808  
..... (XN005710) 1-38832



W08 CS62

..... (XN008710) 1-11808  
..... (XN005710) 1-38832  
..... 900001-944826

W05 CS115  
BRICARD

W70 CS141

..... (XN008710) 1-11808  
..... (XN005710) 1-38832

W72 CS140

..... (XN008710) 1-11808  
..... (XN005710) 1-38832

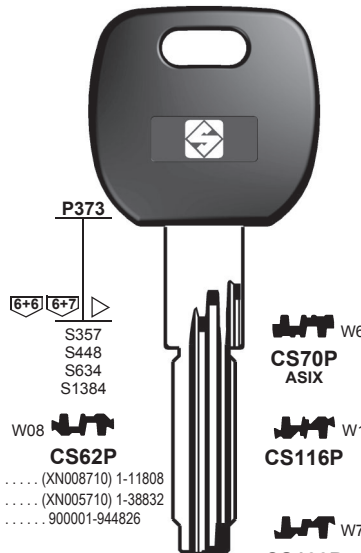

P373  
6+6 | 6+7  
S357  
S448  
S634  
S1384

W60 CS70P  
ASIX

W13 CS116P

W76 CS139P



NEW ASTRAL

Copyright by Silca S.p.A. 2018 - All Rights Reserved

PER:  
FOR:

# CISA

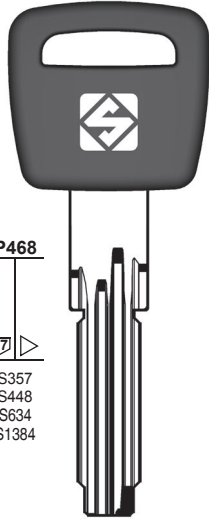

W08 **CS62AP**

..... 900001-944826  
..... (XN008710) 1-11808  
..... (XN005710) 1-38832



**CS155AP**

**CS154AP**

W76 **CS139AP**

W13 **CS116AP**

W60 **CS70AP**

**CS159AP**

**CS158AP**

**CS157AP**

**CS156AP**



# 57

PER / FOR

**CISA (IT)**

ABUS

ALA

BATU

CIBC

CIGNO

IFAM

KUNERT

LOGO

LOK 2000

+ ABUS (6-7-8-10)

+ ALA (14)

PER:  
FOR:

# CISA

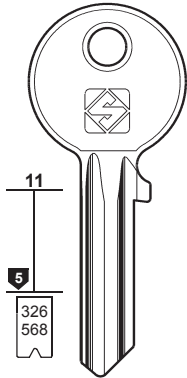

**CS21** **CS21R**

..... 1-2-3-4-5-6

**CS7** **CS7R**

A..... 1-01321  
..... 1-2-3-4-5-6



mm 40

**BATU - CIBC**  
**IFAM - KUNERT - LOGO**

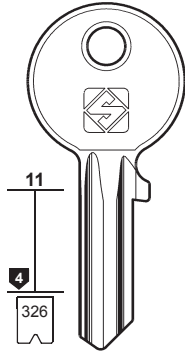

**CS6** **CS6R**

..... 1-2-3-4-5-6  
EA... 1-738



mm 30

**ABUS**

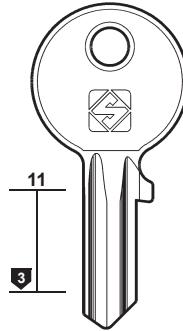

**CS5** **CS5R**

**LOK 2000**  
**ABUS**

PER:  
FOR:

# CISA

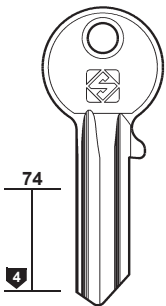

**CS22** **CS22R**

**LOGO** **LOGO**

**CS8** **CS8R**



mm 30

**IFAM**

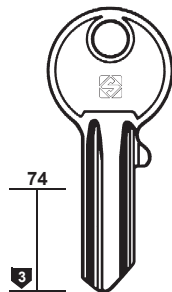

**CS9** **CS9R**



mm 20-25

**CIGNO**

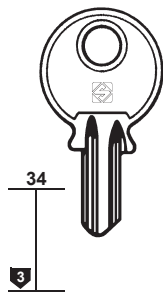

**CS12** **CS12R**



mm 15

**ABUS - ALA**

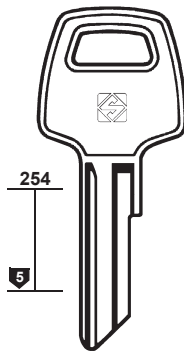

**CS10** **CS10R**

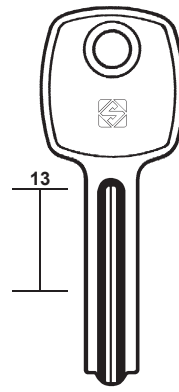

**CS11**





58

PER / FOR

CISA (IT)

BASI  
CITY  
IFAM  
+ ABUS (6-7-8-10)  
+ ALA (14)

CITY (FR)

ATP  
CAP  
CAVERS  
FO  
PROTEC  
QCP  
SIAM  
SOS  
VIP  
ZENITH  
+ BUGA (40)  
+ CISA (58)  
+ FTH (91)

CKS (DE)

YALE (212)

CLASSIC (DE)

ABUS (7)

PER:  
FOR:

CISA

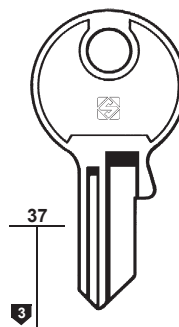
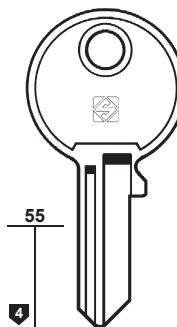
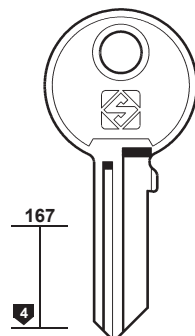
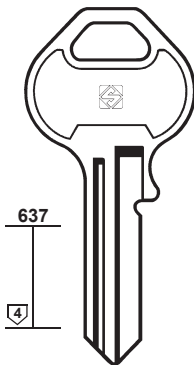
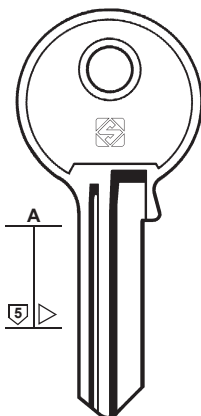

CS33 CS33R



BASI



CS32 CS32R



BASI - CITY



CS19 CS19R



BASI



CS26



CS26R



CITY



CS27



CS27R



PER:  
FOR:

CISA

CITY

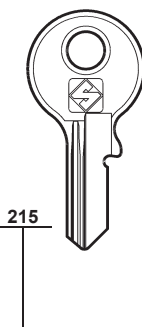

215



CS45



CS45R

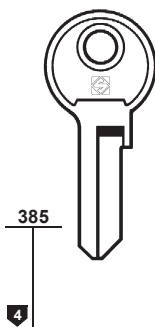

385



CS20



CS20R

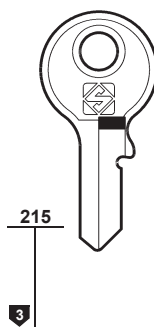

215



CS23



CS23R



BASI - IFAM



277



CS28



CS28R

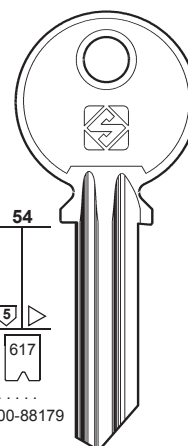

54

617

81000-88179



CA15

PER:  
FOR:

CITY

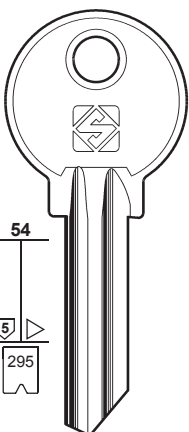

54

295



CA2R

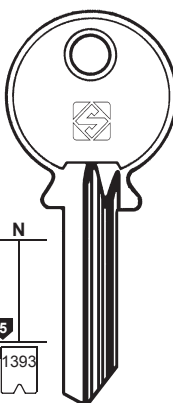

N

1393



CA1

160 ... 000-999  
16 ... 1000-6288

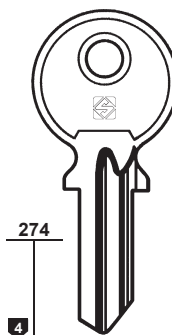

274



CA3

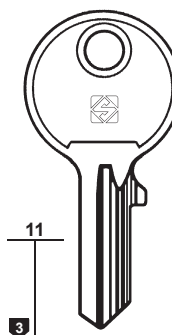

11



CA4

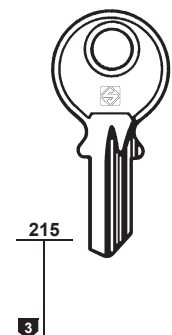

215



CA5

ATP - CAP - FO  
PROTEC - QCP - SIAM  
SOS - VIP - ZENITH

CAVERS

CAVERS

CAVERS

CAVERS

PER:  
FOR:

**CLAUSOR**

**CLUB**

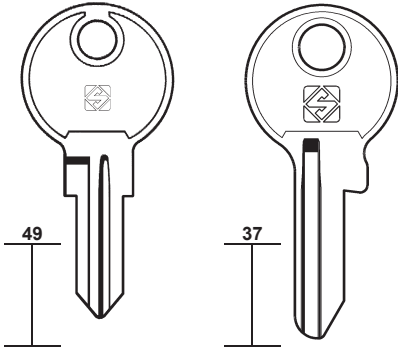

**CR2R**      **CR5R**



**BRABANTIA  
CASH BOX - ELSET**

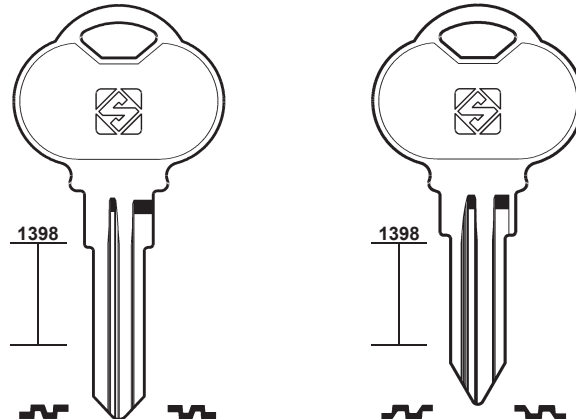

**CLU1**      **CLU1R**      **CLU4**      **CLU4R**  
**CLU2**      **CLU2R**  
**CLU3**      **CLU3R**



**59**

PER / FOR

**CLAUSOR (ES)**  
BRABANTIA  
CASH BOX  
ELSET  
+ ME-FA (135)

**CLUB (US)**

**CODEM (FR)**  
FTH (92)

**CODKEY (IL)**  
SPIDER (174)

**COLE (US)**  
ROYAL

**COLE-HERSEE (US)**  
YALE (213)

**COLL (BY)**

**COLOMENCA (ES)**  
AGA (11)

**COMBA (DE)**  
CES (48)  
KFV (116)  
TOK-WINKHAUS (186)

**CONCEPT (BR)**

**CORBIN (IT)**  
MERMIER  
OAL  
POPLOCK

PER:  
FOR:

**COLE**

**COLL**

**CONCEPT**

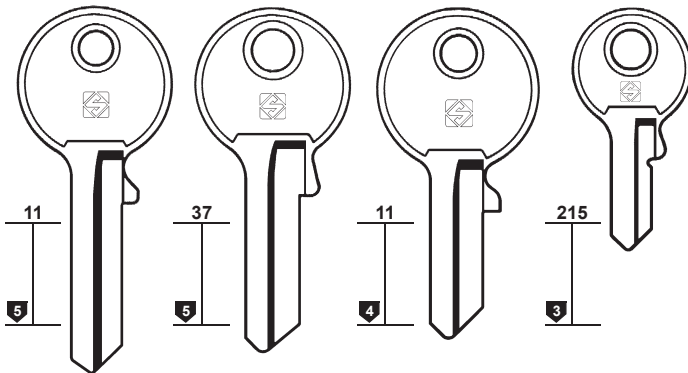

**COL1**      **COL2**      **COL3**      **COL4**



ROYAL

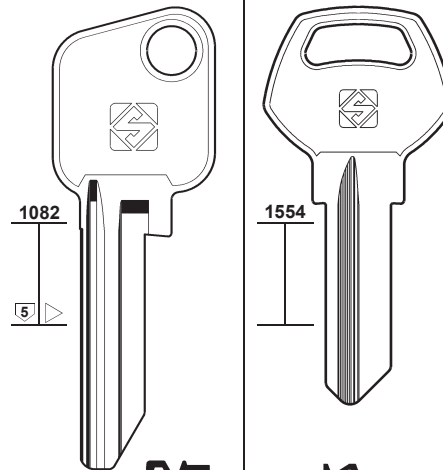

**CLL1**      **CNP1R**

PER:  
FOR:

**CORBIN (IT)**

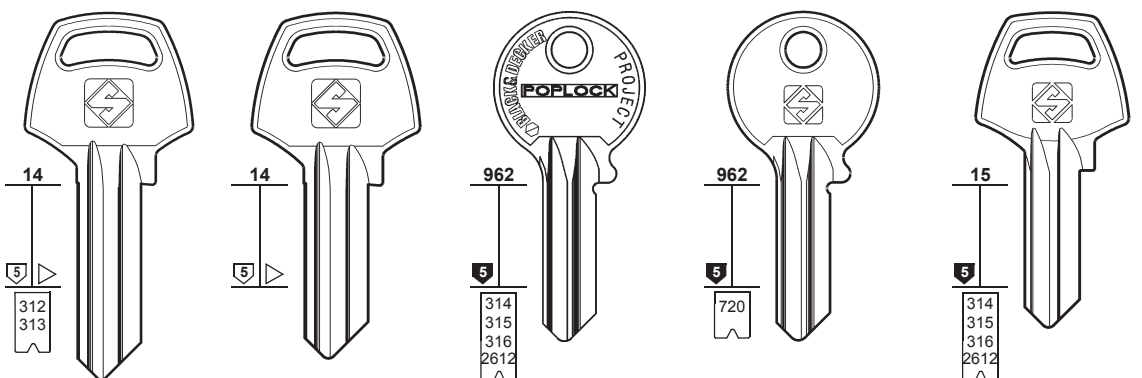

**CB1**      **CB1R**      **CB2**      **CB2R**      **CB3-OR**      **CB80**      **CB3**      **CB3R**

..... 2-3-4-5-6-7-8-9  
..... 1-2-3-4-5-6-7-8-9

..... 1-2-3-4-5-6-7-8-9  
..... 2-3-4-5-6-7  
..... 1-2-3-4-5-6-7-8

..... 1-2-3-4-5

..... 1-2-3-4-5-6-7-8-9  
..... 2-3-4-5-6-7  
..... 1-2-3-4-5-6-7-8



mm 26-45-50-60

**MERMIER - OAL**



mm 23

**OAL**

**POPLOCK**



mm 21-40

**OAL**



60

PER / FOR

**CORBIN (IT)**  
 ALUNORM  
 BWS  
 CORNI  
 CRC-CAMBÒA  
 DOM  
 ESCO  
 EURONORM  
 FEB  
 HEGO  
 HESTE  
 ISSERSTEDT  
 KAWE  
 LITTO  
 MERMIER  
 MUKRA  
 NEMEF  
 NOVOFERM  
 POPLOCK  
 STREMLER  
 SUL  
 THÒNE  
 VERSCO  
 WÜRTH  
 ZEÇE

PER: CORBIN (IT)  
FOR:

Key 1: Length 963, bitting 4, bitting pattern 1-2-3-4-5

Key 2: Length 963, bitting 4, bitting pattern 1-2-3-4-5

Key 3: Length 15, bitting 4, bitting pattern 314, 315, 316, 2612

Key 4: Length 964, bitting 5, bitting pattern 323

Key 5: Length 964, bitting 3, bitting pattern 717

Key 6: Length 285, bitting 3, bitting pattern 323

Profiles: CB4-OR, CB81, CB4, CB4R, CB9-OR, CB79, CB9

Icons: Lock, Door handle

Dimensions: mm 17,5, mm 11,5-20-25

Labels: POPLOCK

PER: CORBIN (IT)  
FOR:

Key 1: Length 11, bitting 5, profile CB85

Key 2: Length 37, bitting 5, profile CB15 025

Key 3: Length 277, bitting 4, bitting pattern 718, profile CB70

Key 4: Length 961, bitting 5, bitting pattern 317, 318, 327, 798, 1400, profile CB6-OR

Profile: CB6-OR

Icon: Lock

Label: POPLOCK

PER: CORBIN (IT)  
FOR:

Key 1: Length 214, bitting 5, bitting pattern 317, 318, 1400, mm 28, profile CB6

Key 2: Length 214, bitting 5, bitting pattern 321, 322, mm 26, profile CB5

Key 3: Length 214, bitting 5, bitting pattern 321, 322, mm 25, profile CB5R

Key 4: Length 214, bitting 4, bitting pattern 319, 320, mm 23, profile CB8

Key 5: Length 214, bitting 4, bitting pattern 319, 320, mm 23, profile CB7

Key 6: Length 214, bitting 4, bitting pattern 319, 320, mm 23, profile CB7R

Profiles: CB6, CB6R, CB16 A1, CB105R, CB17, CB103R, CB19 B1, CB95R, CB32, CB96R, CB42, CB99R, CB43R, CB100R, CB78R, CB101R

Profiles: CB5, CB5R, CB8, CB7, CB7R

Bitting patterns: 1-2-3-4-5-6-7-8-9, 0-1-2-3-4-5-6-7-8, 8-7-6-5-4-3-2-1-0, 012345678, 123456, DX 123456, 123456789, 876543210

Dimensions: mm 28, mm 26, mm 25, mm 23

Label: BWS

Label: ESCO - EURONORM KAWE - MUKRA

PER:  
FOR:

### CORBIN (IT)

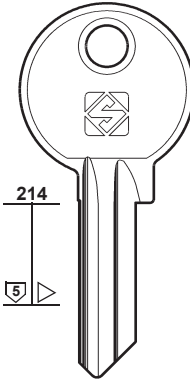
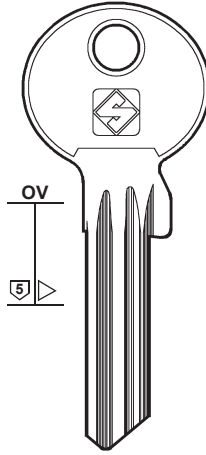
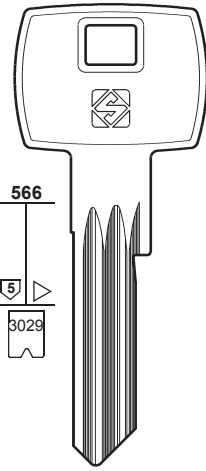
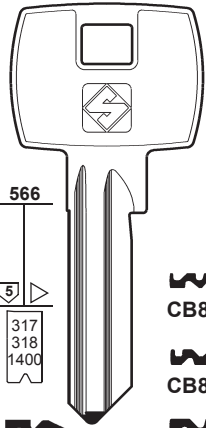

- CB89R**
- CB88R**
- CB31**
- CB84**  
..... 1-2-3-4-5-6-7
- CB30**
- CB30R**  
..... 1-2-3-4-5-6-7-8-9  
..... 0-1-2-3-4-5-6-7-8  
..... 8-7-6-5-4-3-2-1-0

- CB90R**
- CB86**  
..... 1-2-3-4-5-6-7

- CB104R**
- CB106**

- CB21**

TESIO



# 61

PER / FOR

**CORBIN (IT)**  
TESIO

**CORBIN (US)**  
SKILMANN

PER:  
FOR:

### CORBIN (IT)

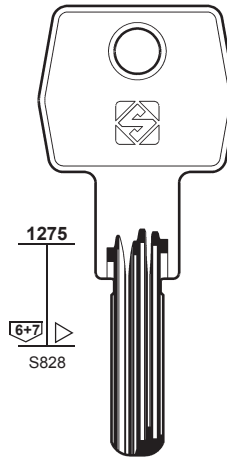
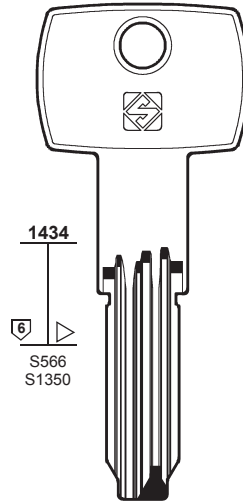
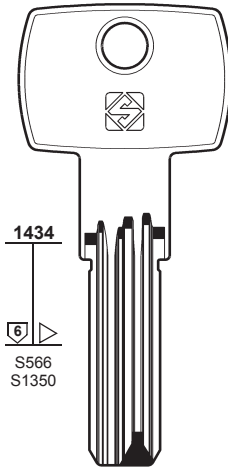
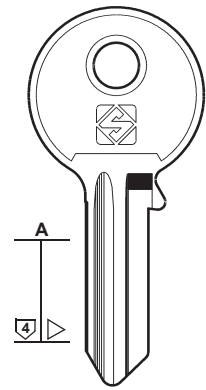

**CB83**

**CB87**

**CB97**

**CB98**



"Euro Star Plus"



PER:  
FOR:

### CORBIN (US)

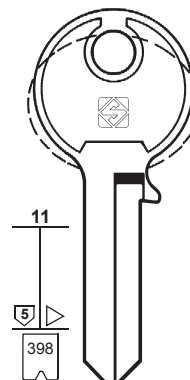
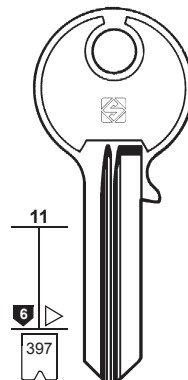
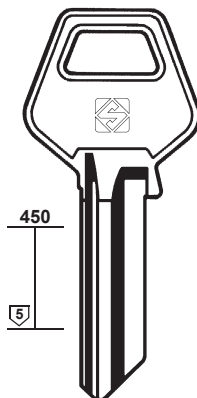
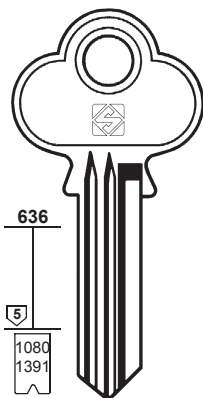
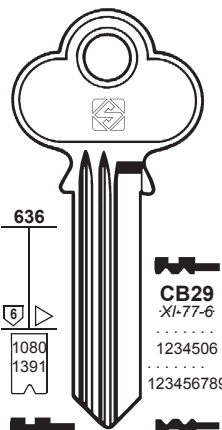

**CB12**

**CB29R**  
..... 1234506  
..... 123456789

**CB11**  
*XI-77-5*  
..... 1234567890

**CB11R**

**CB18**

**CB28R**  
4R .....  
0-1-2-3-4-5-6-7-8

9R .....  
0-1-2-3-4-5-6-7-8

**CB38**

**CB38R**  
B4R .....  
0-1-2-3-4-5-6-7-8-9

4T .....  
0-1-2-3-4-5-6-7-8-9

**CB12R**

**CB82**

**CB37**  
..... 1234506  
..... 1234567890

**CB39R**  
..... 1234506  
..... 1234567890

SKILMANN



62

PER / FOR

CORBIN (US)  
CCL  
CHANGE-O-MATIC  
EMHART  
LANE

CORNI (IT)

333  
BETA  
CIC  
EURONORM  
FONTAINE  
MUL.T.LOCK  
+ CORBIN (60)

PER: CORBIN (US)  
FOR:

520 520 520 520 856

6 458 7 1290 6 396 1253 1290 5 396 1290 6 458

CB34R ..... 1234567  
CB25R ..... 1234506  
CB40R ..... 1234506  
CB26R ..... 1234567890  
CB33R ..... 1234506  
CB27R ..... 1234506  
          ..... 1234567890  
          M ..... 1234567890  
CB22R ..... 1234567  
CB23R ..... 1234567890  
          M ..... 1234567890  
CB24R ..... 1234567890  
          M ..... 1234567890  
CB41R ..... 1234567890  
          M ..... 1234567890  
CB44R .....  
          1-2-3-4-5-6-7

PER: CORBIN (US)  
FOR:

A 520 214 233 265

5 5 5 4 4

CB20      CB102R      CB10      CB13      CB13R      CB14      CB14R

2A ..... 0-1-2-3-4-5-6-7-8-9  
7A ..... 0-1-2-3-4-5-6-7-8-9  
8P ..... 0-1-2-3-4-5-6-7-8-9

EMHART      CHANGE-O-MATIC      CCL

PER: CORNI  
FOR:

10 10 10 10

5 4 3 5

325 1432 1433 325 325 325 325 325

CC5 ..... 1-1000  
48 ..... 1-1000  
CC4 ..... 0-1-2-3-4-5-6-7-8-9  
CC2 ..... 1-1000  
48 ..... 1-1000  
          ..... 28001-29000  
          ..... 80000-80625  
          ..... 85000-86000  
          ..... 86000-87000  
CC3 ..... 0-1-2-3-4-5-6-7-8-9  
CC3R ..... 0-1-2-3-4-5-6-7-8-9  
CC7 ..... 0-1-2-3-4-5-6-7-8-9  
CC7R ..... 0-1-2-3-4-5-6-7-8-9  
CC6R ..... 0-1-2-3-4-5-6-7-8-9

333 - BETA - CIC      BETA      BETA      FONTAINE  
EURONORM      MUL.T.LOCK



PER: FOR:	CORNI	CORONA	COTICO
	<p>N 11 5 324</p>	<p>A 1112 5</p>	<p>OV 5</p>
	<p>CC1 CC1R CC8 1-2-3-4-5</p>	<p>COR1 COR2 COR2R</p>	<p>CO1 CO1R</p>
		BAB - BUG - DOCO GEBRO - ZEISS IKON	



**63**

- PER / FOR**
- CORNI (IT)**  
+ CORBIN (60)
  - CORONA (DE)**  
BAB  
BUG  
DOCO  
GEBRO  
ZEISS IKON  
+ BAB (28)  
+ ZEISS IKON (221)
  - COTICO (DE)**
  - COUILLET (FR)**  
 RICOUARD (160)
  - C.R. (IT)**
  - CRC-CAMBÔA (PT)**  
 CORBIN (60)
  - CRISTANI (IT)**  
R.C.
  - CROWN (TW)**
  - CVL (ES)**
  - CWS (DE)**  
 DOM (68)

PER: FOR:	C.R.	CRISTANI	CROWN
	<p>OV 5</p>	<p>A 5 A 4</p>	<p>277 3</p>
	<p>C1 C1R</p>	<p>CT2 CT2R CT1 CT1R</p>	<p>CW1</p>
		R.C.	<p>mm 30</p>

PER: FOR:	CVL			
	<p>A 5</p>	<p>A 5 808</p>	<p>129 4</p>	<p>1214 4 S195</p>
	<p>CVL1 CVL1R</p>	<p>CVL3 CVL3R ..... 1-2-3-4-5-6-7</p>	<p>CVL2 CVL2R</p>	<p>CVL5R ..... IC 8-7-6-5-4-3</p>
		<p>CVL4</p>		



64

PER / FOR

DAC (GR)

DAD (FR)

DECAYEUX

+ FORT (90)

+ L & F (128-129)

+ RONIS (161)

+ VACHETTE (198-199)

DAF (TR)

DAIYA (TW)

DALWA (JP)

LIPS

DAMM (DE)

BKS (34)

DAV (FR)

RONIS (161)

DC (FR)

RONIS (161)

DE ANGELI (IT)

DEBEAURAIN (FR)

RONIS (161)

DECAYEUX (FR)

DAD (64)

DOM (69)

FORT (90)

O.NOVOX (150)

PICARDIE (155)

RICOUARD (160)

DEF (FR)

KIFERM (117)

DEFEND LOCK (CZ)

DEHA (TW)

YETI (218-219)

PER: FOR:	DAC	DAD		DAF	
		DECAYEUX			

PER: FOR:	DAF	DAIYA	DALWA	DE ANGELI
			LIPS	

PER: FOR:	DEFEND LOCK		

PER:  
FOR:

# DEKABA

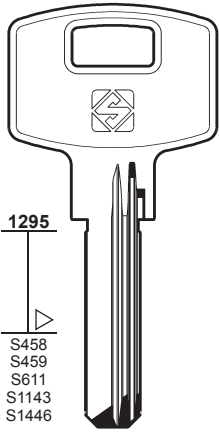

1295

S458  
S459  
S611  
S1143  
S1446



**DK1**

..... 00001-85798  
..... 000001-028000



MAUER

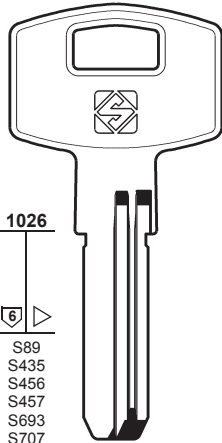

1026

S89  
S435  
S456  
S457  
S693  
S707  
S708  
S1144

..... 000016-280006



**DK3**

E2



**DK6**

E2

MAUER

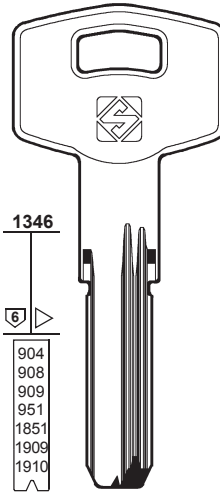

1346

904  
908  
909  
951  
1851  
1909  
1910



**DK6X**

..... 00016-280006



# 65

PER / FOR

**DEKABA** (BG)  
MAUER  
+ MAUER (132)

**DELCA** (GR)  
GEVY

**DELTA** (FR)  
RONIS (161)

**DERLOCHE** (FR)  
RONIS (161)

**DESPREZ** (FR)  
GABON (93)  
RONIS (161)

**DETHLEF** (GB)  
EURO-LOCKS (80)

**DEXTER** (IT)

PER:  
FOR:

# DEKABA

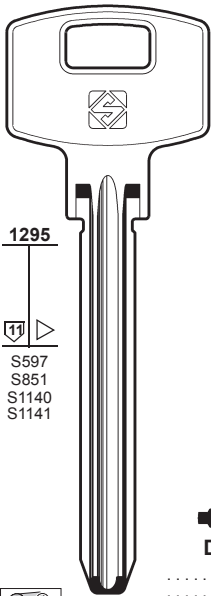

1295

S597  
S851  
S1140  
S1141



**DK7**

..... 000002-111985  
..... 000003-129307



MAUER

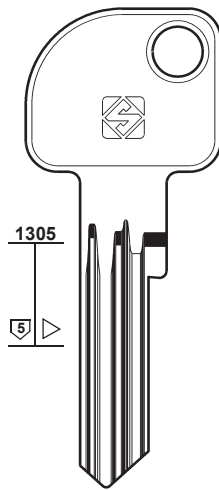

1305



**DK5**

F

MAUER

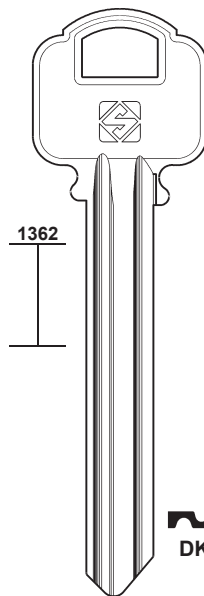

1362



**DK4**

MAUER

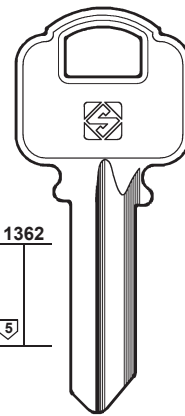

1362



**DK8R**



**DK9R**

PER:  
FOR:

# DELCA

# DEXTER

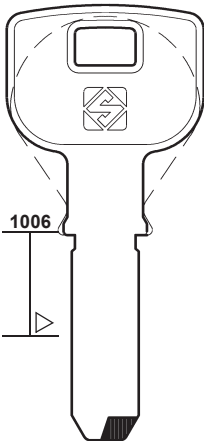

1006

**DLC1**

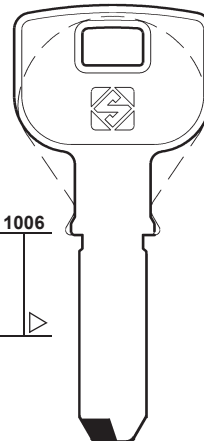

1006

**DLC1R**

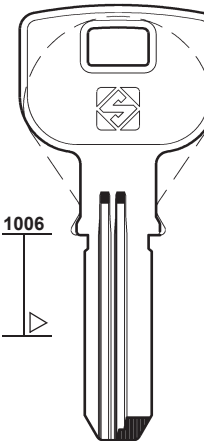

1006

**DLC2R**

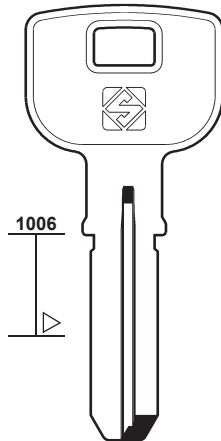

1006

**DLC3**

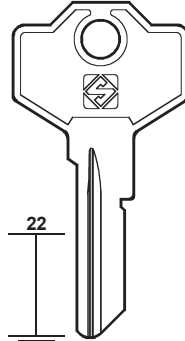

22

207

**GS4R**

E.....  
9001-9741



GEVY

GEVY





66

PER / FOR

DEXTER (IT)

DIAMA (FR)

FTH (90)

DIAMOND (TW)

PER:  
FOR:

### DEXTER

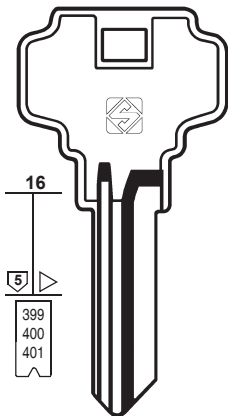

..... 0-1-2-3-4-5-6-7  
..... 0-1-2-3-4-5-6-7  
..... 0-1-2-3-4-5-6-7-8-9  
..... T 0-1-2-3-4-5-6-7-8-9

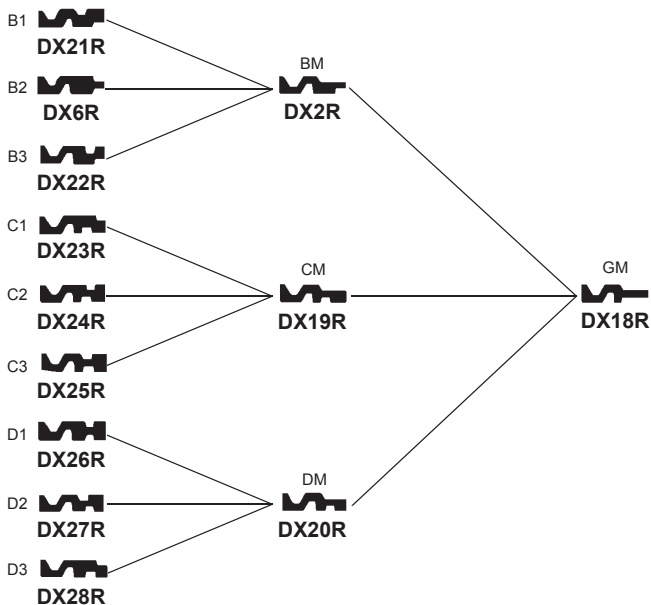

PER:  
FOR:

### DEXTER

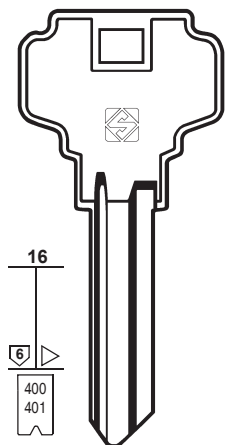

..... 0-1-2-3-4-5-6-7  
..... 0-1-2-3-4-5-6-7-8-9  
..... T 0-1-2-3-4-5-6-7-8-9

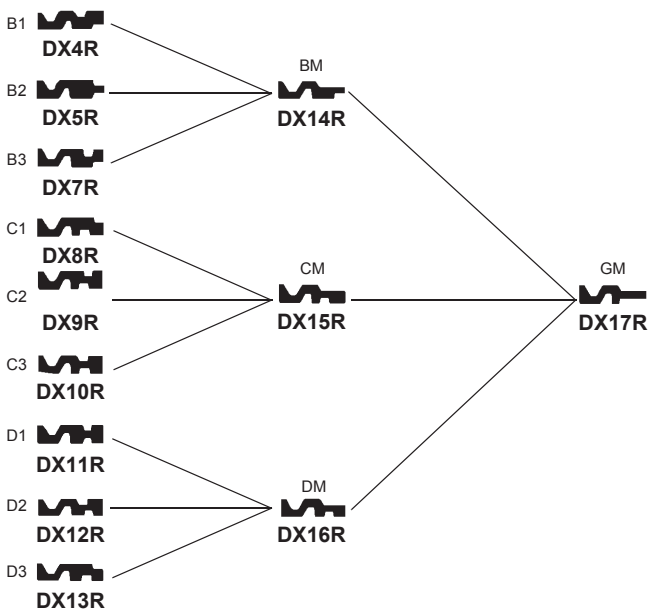

PER:  
FOR:

### DIAMOND

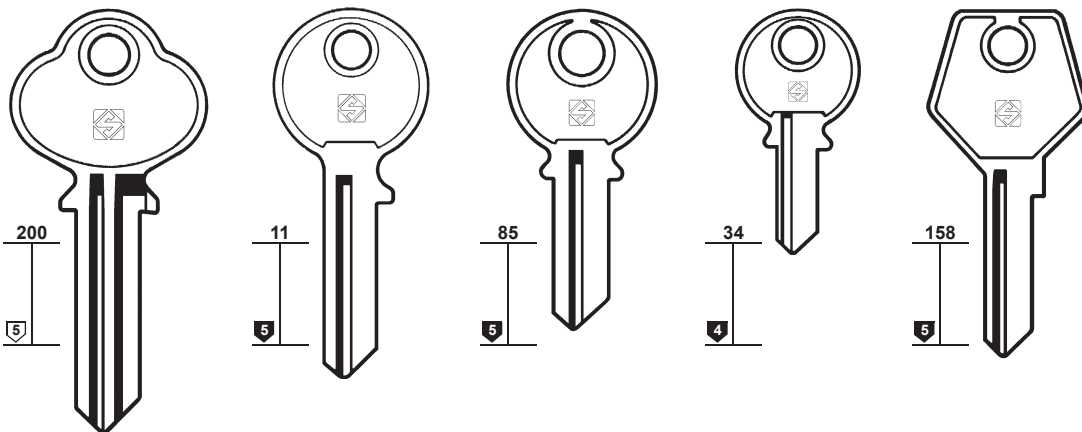

DN2



DN3



DN1



DN9R



DN4



PER:  
FOR:

### DIAMOND

### DIERRE

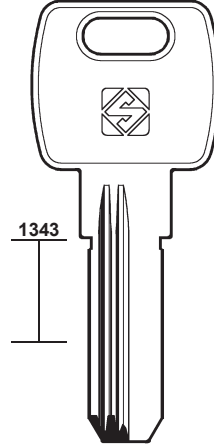
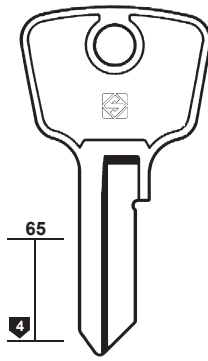
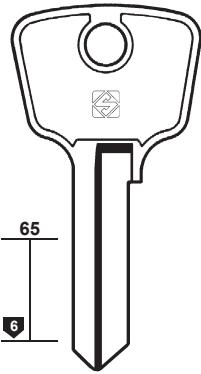
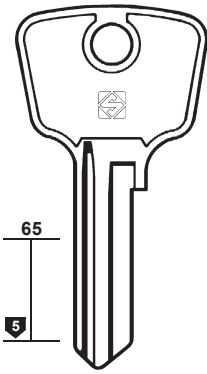
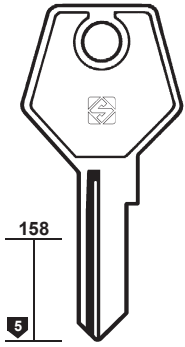

# 67



DN5



DN7



DN6



DN8



DIR1R



PER:  
FOR:

### DINBOX

### DIMITROVGRAD

### DLP (D. LA PORTE)

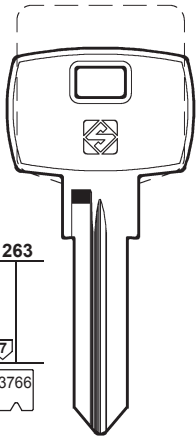

DBX1R  
..... 1-2-3

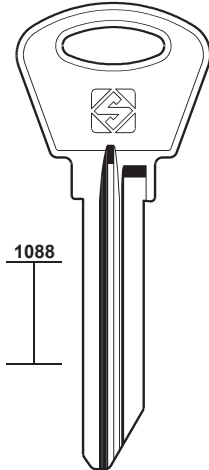

DMT1R

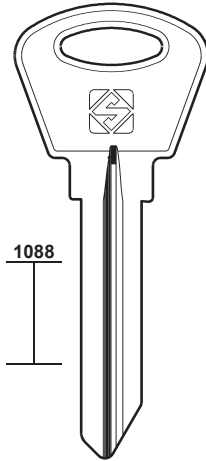

RUS3R

DMT2R

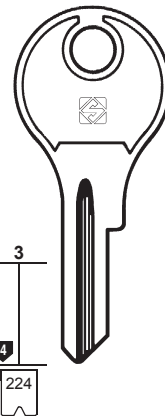

DL1R

..... 2501-2550

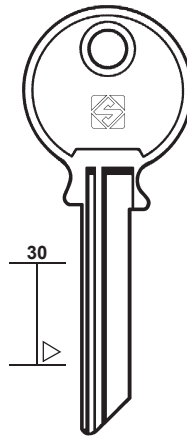

LAP3

3766

224



PER:  
FOR:

### DLP (D. LA PORTE)

### DNEPROPETROVSK

### DOBLINA

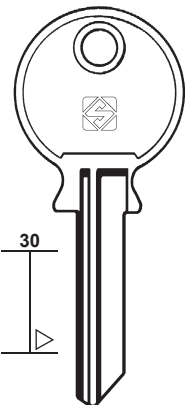

LAP2

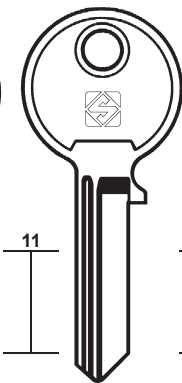

DL3

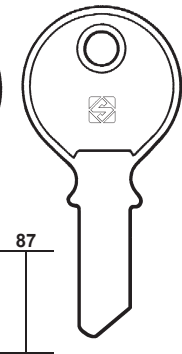

DL2

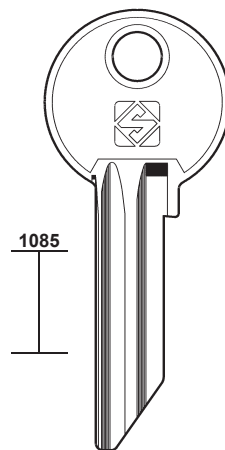

FMK1

FIMANEVSKI

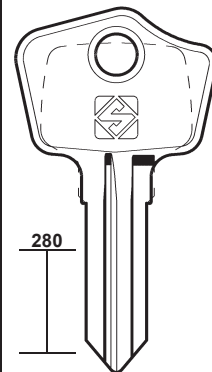

DB60

PER / FOR

DIAMOND (TW)

DIERRE (IT)  
+ WILKA (210)

DIFA (DK)  
+ RUKO (162)

DIMITROVGRAD (RU)

DINBOX (SE)

DISQUIN (FR)  
+ TOK-WINKHAUS (185)

DLP (D. LA PORTE) (DE)  
+ LA PORTE (121)

DNEPROPETROVSK (UA)  
FIMANEVSKI

DNS (GB)  
+ EAGLE (75)

DOBLINA (DE)



68

PER / FOR

DOBLINA (DE)

DOBUS (DE)

👁️ CISA (55)

DOCO (DE)

👁️ CORONA (63)

DOFIN (FR)

👁️ GLOBE (97)

DOM (DE)

BARRO

BTV

CHRIST

CWS

DECAYEUX

EAO

HÄFELE

HEKNA

HUWIL

IDEAL

MENOVA

METEOR

MLM

RUKA

SCHLEGEL

SINJET

STS

SWISSTAC

TM

+ 👁️ CORBIN (60)

+ 👁️ EMR (77)

+ 👁️ MLM (141)

+ 👁️ STUV (178)

PER:  
FOR:

DOBLINA

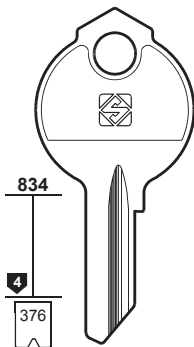

... 201-626

DB1	DB1R
35 ...	34 ...
DB2	DB2R
U ...	V ...
DB3	DB3R
2 ...	1 ...
DB4	DB4R
3 ...	4 ...
DB5	DB5R
6 ...	5 ...
DB6	DB6R
8 ...	7 ...
DB7	DB7R
11 ...	12 ...
DB8	DB8R
14 ...	13 ...
DB9	DB9R
15 ...	16 ...
DB10	DB10R
17 ...	18 ...
DB11	DB11R
20 ...	21 ...

	DB12	22 ...
	DB13	25 ...
	DB14	27 ...
	DB15	29 ...
	DB16	31 ...
	DB17	32 ...
	DB18	36 ...
	DB19	39 ...
	DB20	40 ...
	DB21	42 ...
	DB22	44 ...
	DB23	47 ...
	DB24	48 ...
	DB25	51 ...
	DB26	53 ...
	DB27	54 ...

	DB12R	23 ...
	DB13R	24 ...
	DB14R	26 ...
	DB15R	28 ...
	DB16R	30 ...
	DB17R	33 ...
	DB18R	37 ...
	DB19R	38 ...
	DB20R	41 ...
	DB21R	43 ...
	DB22R	45 ...
	DB23R	46 ...
	DB24R	49 ...
	DB25R	50 ...
	DB26R	52 ...
	DB27R	55 ...

	DB28	120 ...
	DB29	122 ...
	DB30	125 ...
	DB31	130 ...
	DB32	132 ...
	DB33	134 ...
	DB34	136 ...
	DB35	138 ...
	DB36	141 ...
	DB37	142 ...
	DB38	145 ...
	DB39	147 ...
	DB40	148 ...
	DB41	B ...
	DB42	D ...
	DB43	F ...

	DB28R	121 ...
	DB29R	123 ...
	DB30R	124 ...
	DB31R	131 ...
	DB32R	133 ...
	DB33R	135 ...
	DB34R	137 ...
	DB35R	139 ...
	DB36R	140 ...
	DB37R	143 ...
	DB38R	144 ...
	DB39R	146 ...
	DB40R	149 ...
	DB41R	A ...
	DB42R	C ...
	DB43R	E ...

	DB44	H ...
	DB45	L ...
	DB46	M ...
	DB47	P ...
	DB48	S ...
	DB49	Y ...
	DB50	1Z ...
	DB51	1A ...
	DB53	1E ...
	DB54	1H ...
	DB55	1K ...
	DB56	1M ...
	DB57	1R ...
	DB58	1T ...
	DB59	1X ...

	DB44R	G ...
	DB45R	K ...
	DB46R	N ...
	DB47R	R ...
	DB48R	T ...
	DB49R	Z ...
	DB50R	1Y ...
	DB51R	1B ...
	DB53R	1F ...
	DB54R	1G ...
	DB55R	1L ...
	DB56R	1N ...
	DB57R	1P ...
	DB58R	1S ...
	DB59R	1W ...

PER:  
FOR:

DOM

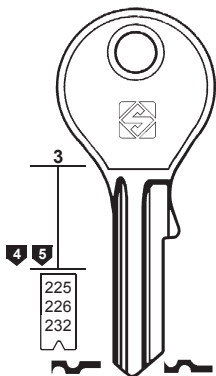

DM4 DM4R  
..... 80138-80748  
..... 80761-83242  
DN ... 1-120

▷ DM61 DM61R  
GS ... 1-1000  
..... 1-1000



BARRO - IDEAL - TM

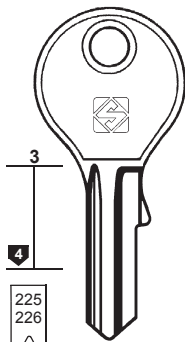

DM6  
..... 80138-80748  
..... 80761-83242

▷ DM6R  
..... 80138-80748  
GP ... 1-250  
C ... 1001-1200  
CL ... 1-250  
C ... 1301-1500

CHRIST

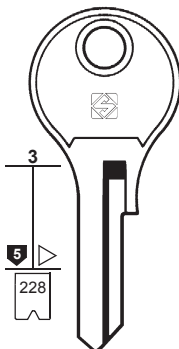

DM39 DM39R  
6E ... 1-205  
7E ... 269-473



EAO - SWISSTAC

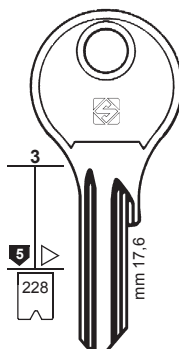

DM8 DM8R  
2D ... 1-222  
5A ... 1-2600  
9A ... 1-5200  
W ... 1-50  
1D ... 601-654  
2W ... 1-50

BTV - DECAYEUX  
HÄFELE - HEKNA  
HUWIL - METEOR  
MLM - RUKA  
SCHLEGEL - STS

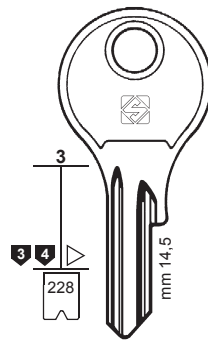

DM10 DM10R  
2A ... 1-34  
DB ... 1-148  
CF ... 1-140  
3A ... 1-82  
1D ... 1-482  
1D ... 501-560  
1D ... 1-57  
FG ... 1-615  
FS ... 1-60

CWS - HÄFELE  
HEKNA - HUWIL  
MENOVA - METEOR  
MLM - RUKA  
SINJET

PER:  
FOR:

# DOM

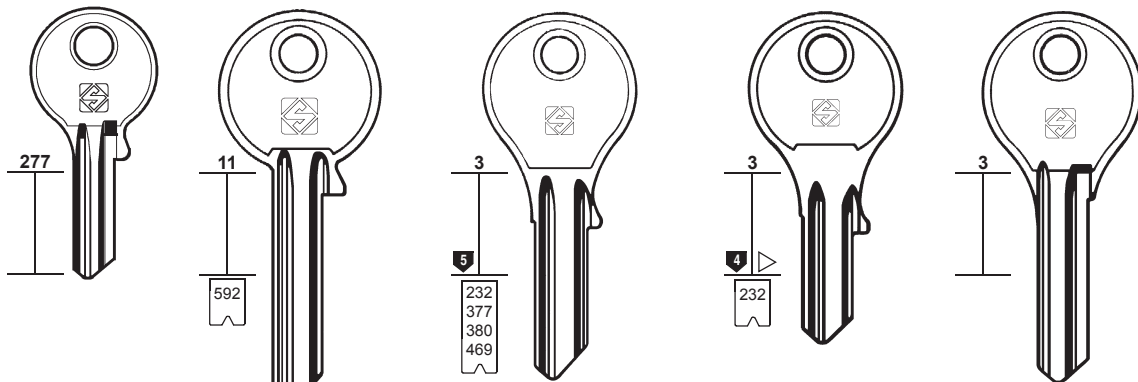

DM153

DM13

DM13R

DM2

DM2R

DM23

DM23R

DM5

DM5R

DM96  
1E... 1-160

DM104R  
KNK

DM62 DM62R  
NOBO



LISTA



# 69

PER / FOR

DOM (DE)

FLAMBO  
GEWIRU  
HEKNA  
LISTA  
NOBO  
PEROHAUS  
RAFI

- + CORBIN (60)
- + EMR (77)
- + MLM (141)
- + STUV (178)

PER:  
FOR:

# DOM

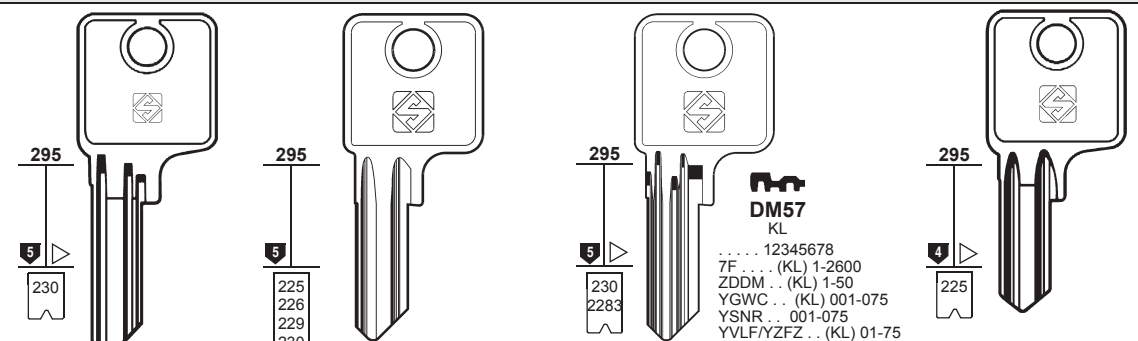

DM41

DM41R

DM16

DM16R

DM57

KL  
... 12345678  
7F... (KL) 1-2600  
ZDDM... (KL) 1-50  
YGWC... (KL) 001-075  
YSNR... 001-075  
YVLF/YZFY... (KL) 01-75

DM37

DM37R

DM38

DM52

ZDDM... 51-100  
7F... (KM) 5201-5205  
YSNR... 001-075  
YVLF/YZFY... (KL) 01-75

DM19

DM19R

DC... 1-1800  
K... 1-50  
GD... 1-1800  
GZ... 1-1800  
3E... 1-350  
2C... 1-2600  
DN... 1-120  
80138-80748  
80761-83242  
FLAMBO - HEKNA  
NOBO - PEROHAUS

VN

DM111

WS  
YSNR... (WS) 2701-2775  
YZFY... (WS) 2701-2775  
WL  
DM113  
YSNR... (WL) 2701-2775  
YZFY... (WL) 2701-2775

DM102

DM36

DM36R

C... 1001-1200  
CL... 1-250  
GP... 1-250  
C... 1301-1500

DM101

DM113

DM137

DM149

GEWIRU

PER:  
FOR:

# DOM

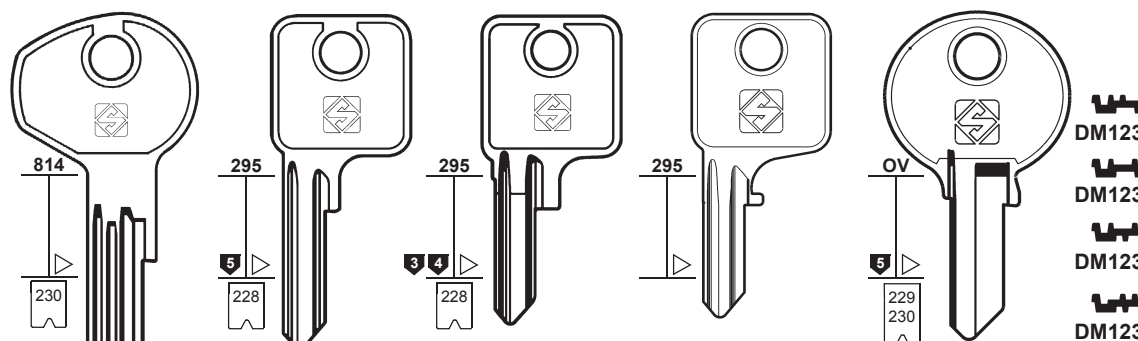

DM123-3

DM123-4

DM123-5

DM123-6

DM123-7

DM123-8

DM123-9

DM123-10

ZDDM... 101-150  
7F... (KN)  
1F... 501-513  
YSNR... 201-275  
YVLF... (KN) 201-275  
YZFY... (KN) 201-275

DM63  
2D... 1-222  
5A... 1-2600  
9A... 1-5200  
W... 1-50

DM34 DM34R  
CF... 1-140  
DB... 1-148  
2A... 1-34  
4A... 1-482  
1D... 1-57  
FG... 1-615  
3A... 1-82  
1D... 501-560

DM110  
1D... 58-114  
2A... 35-68

DM28  
DM111  
2C... 1-2600  
DC... 1-1800  
3E... 1-350  
GD... 1-1800  
GZ... 1-1800  
1C... 1-363  
TB... 1-1796  
YSNR... (VN) 1201-1275  
YSNR... (WN) 2201-2275  
YZFY... (VN) 1201-1275

DM106



RAFI





70

PER / FOR

- DOM (DE)
- CORBIN
- DYES
- EMHART
- FORTSCHRITT
- HÄFELE
- HÖHRMANN
- LISTA
- MAQUET
- MARCO
- MIPPART
- MLM
- STEIGA
- STUV
- VARIO
- VIKI
- VOKO
- + CORBIN (60)
- + EMR (77)
- + MLM (141)
- + STUV (178)

PER:  
FOR:

DOM

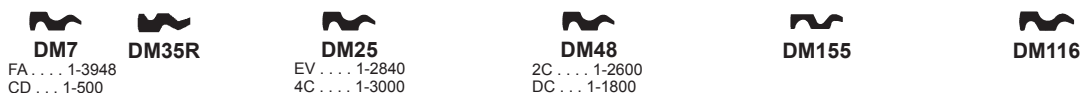
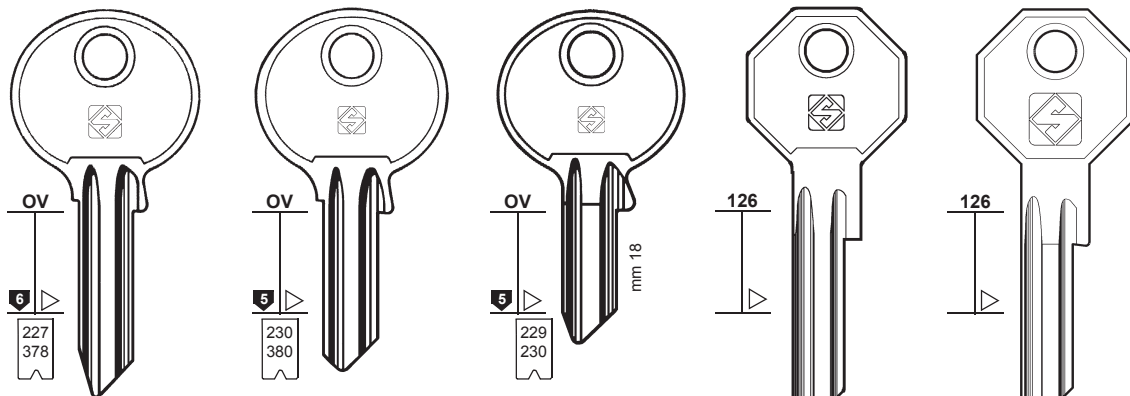

**DM7** FA ... 1-3948  
CD ... 1-500

**DM35R**

**DM25** EV ... 1-2840  
4C ... 1-3000

**DM48** 2C ... 1-2600  
DC ... 1-1800  
3E ... 1-350  
GD ... 1-1800  
GZ ... 1-1800

VARIO

HÖHRMANN

DYES - FORTSCHRITT - HÄFELE  
LISTA - MAQUET - MARCO  
MIPPART - MLM - VOKO

PER:  
FOR:

DOM

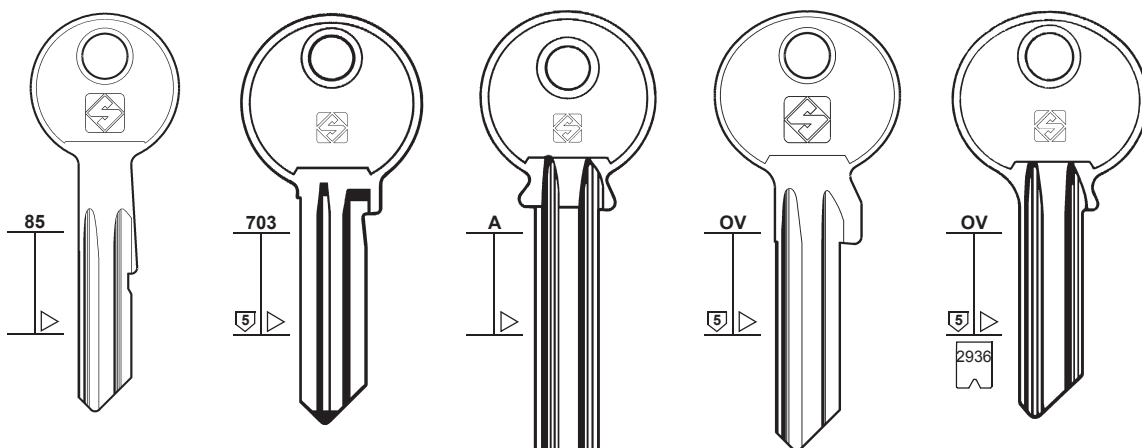

DM114

DM98R  
E

DM32

DM3X

DM3  
... 01234567

DM105R

STEIGA  
STUV - VIKI

PER:  
FOR:

DOM

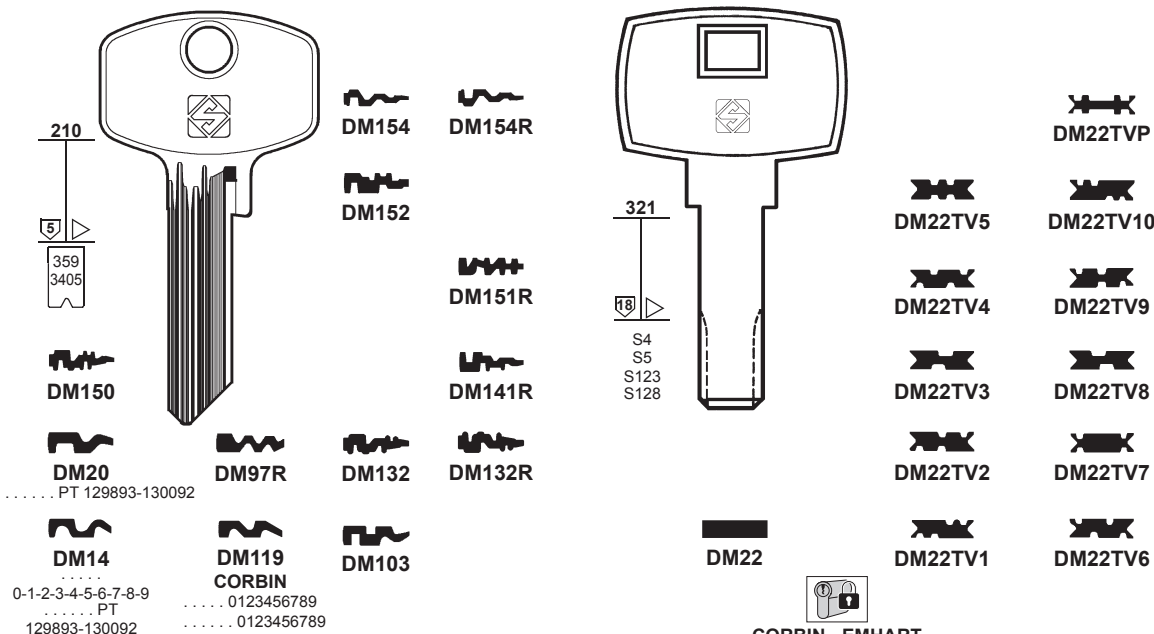

DM150

DM20  
... PT 129893-130092

DM14  
...  
0-1-2-3-4-5-6-7-8-9  
... PT  
129893-130092

DM154

DM152

DM151R

DM141R

DM132

DM132R

DM103

DM154R

DM141R

DM132R

DM132R

DM132R

DM132R

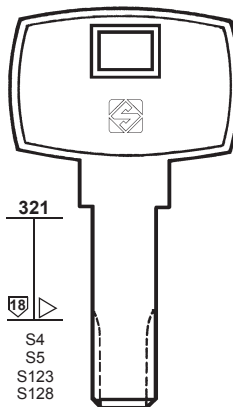

DM22

DM22TVP

DM22TV5

DM22TV4

DM22TV3

DM22TV2

DM22TV1

DM22TV10

DM22TV9

DM22TV8

DM22TV7

DM22TV6



CORBIN - EMHART



PER:  
FOR:

### DOM



# 71

PER / FOR

**DOM** (DE)  
ASPA  
CORBIN  
EMHART  
IR  
LAPERCHE  
MOREAUX  
NOBO  
STS

- + CORBIN (60)
- + EMR (77)
- + MLM (141)
- + STUV (178)

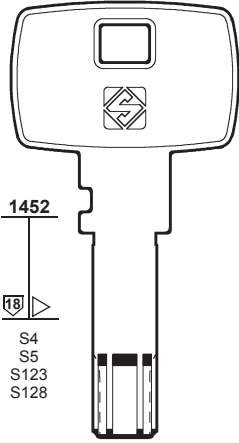

1452

18

S4  
S5  
S123  
S128

**DM22TVPX**   **DM22TV5X**

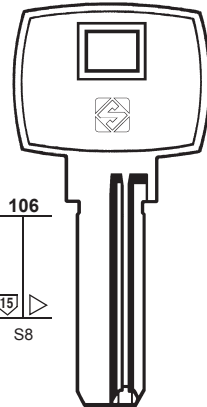

106

15

S8

**DM24**   **DM64**  
IX5

**DM118**

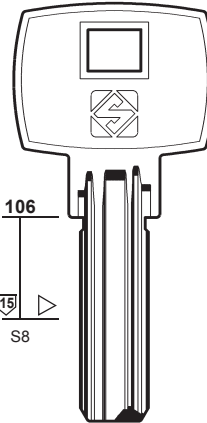

106

15

S8

**DM120**   **DM122**



PER:  
FOR:

### DOM

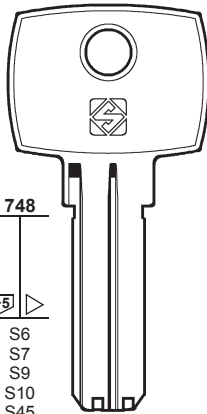

748

5+5

S6  
S7  
S9  
S10  
S45  
S118  
S178

**DM49**   **DM53**

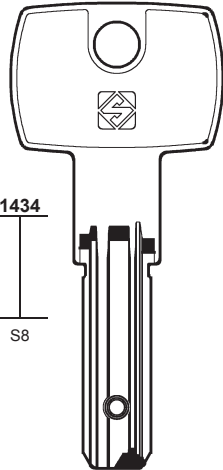

1434

S8

**DM139**   **DM145**  
IX5

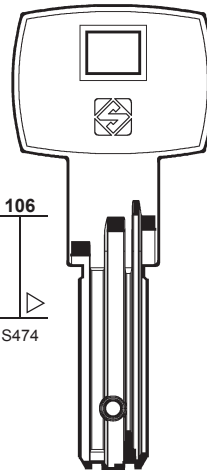

106

S474

**DM144**  
IX6



PER:  
FOR:

### DOM

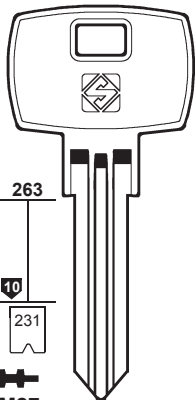

263

10

231

**DM27**  
1H .... 1-4088  
3H .... 1-600

**DM17**   **DM17R**

1H .... 1-4088  
2H .... 1-2088  
3H .... 1-600  
**ASPA**

**NOBO**

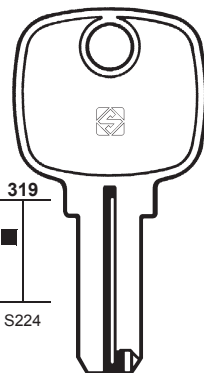

319

S224

**DM21**  
..... 0-1-2-3-4-5



**MOREAUX**

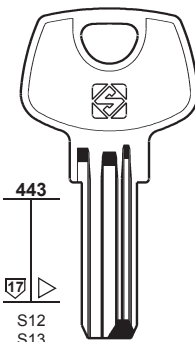

443

17

S12  
S13

**DM138**

**DM55**  
2Y



**ALARM**

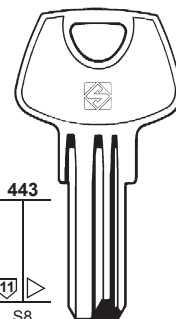

443

11

S8  
S11

**DM128**

**DM58**



**ALARM**



72









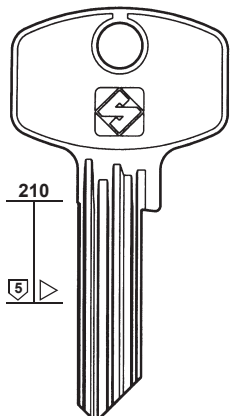



















PER / FOR



















DOM (DE)

PER:  
FOR:

DOM



 DM40 L	 DM40R L	 DM67	 DM67R	 DM66	 DM66R
 DM44 M	 DM44R M			 DM68	 DM68R
 DM18R C	 DM18 C	 DM50	 DM50R	 DM69	 DM69R
 DM42 D	 DM42R D			 DM70	 DM70R
 DM29 P	 DM29R P			 DM74	 DM74R
 DM43 U	 DM43R U			 DM60	 DM60R

 DM47 Q	 DM47R Q	 DM71	 DM71R	 DM45 T	 DM45R T
 DM46 R	 DM46R R	 DM72	 DM72R		
 DM26 S	 DM26R S	 DM73	 DM73R		
		 DM75	 DM75R		
		 DM115	 DM115R		

 DM33R	 DM12-1	 DM12-10	 DM12-19	 DM12-28	 DM12R-12	 DM12-37	 DM12-46
	 DM12-2	 DM12-11	 DM12-20	 DM12-29	 DM12R-13	 DM12-38	 DM12-47
 DM12-00	 DM12-3	 DM12-12	 DM12-21	 DM12-30	 DM12R-16	 DM12-39	
	 DM12-4	 DM12-13	 DM12-22	 DM12-31	 DM12R-19	 DM12-40	
	 DM12-5	 DM12-14	 DM12-23	 DM12-32	 DM12R-31	 DM12-41	
 DM12R-00	 DM12-6	 DM12-15	 DM12-24	 DM12-33	 DM12R-32	 DM12-42	
	 DM12-7	 DM12-16	 DM12-25	 DM12-34	 DM12R-34	 DM12-43	
	 DM12-8	 DM12-17	 DM12-26	 DM12-35	 DM12R-35	 DM12-44	
	 DM12-9	 DM12-18	 DM12-27	 DM12-36	 DM12R-36	 DM12-45	

PER:  
FOR:

# DOM









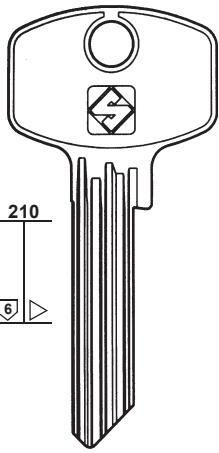



































# 73

PER / FOR

DOM (DE)



 DM86 L	 DM86R L	 DM77	 DM77R	 DM76	 DM76R
 DM87 M	 DM87R M			 DM78	 DM78R
 DM88 C	 DM88R C	 DM108	 DM108R	 DM79	 DM79R
 DM89 D	 DM89R D			 DM80	 DM80R
 DM90 P	 DM90R P			 DM84	 DM84R
	 DM94R U			 DM109	 DM109R

 DM91 Q	 DM91R Q	 DM81	 DM81R	 DM95 T	 DM95R T
 DM92 R	 DM92R R	 DM82	 DM82R		
 DM93 S	 DM93R S	 DM83	 DM83R		
		 DM85	 DM85R		

 DM65-00	 DM65-1	 DM65-10	 DM65-19	 DM65-28	 DM65R-12	 DM65-46
	 DM65-2	 DM65-11	 DM65-20	 DM65-29	 DM65R-13	
 DM65R-00	 DM65-3	 DM65-12	 DM65-21	 DM65-30	 DM65R-16	
	 DM65-4	 DM65-13	 DM65-22	 DM65-31	 DM65R-19	 DM65-40
	 DM65-5	 DM65-14	 DM65-23	 DM65-32	 DM65R-31	 DM65-41
	 DM65-6	 DM65-15	 DM65-24	 DM65-33	 DM65R-32	 DM65-42
	 DM65-7	 DM65-16	 DM65-25	 DM65-34	 DM65R-34	 DM65-43
	 DM65-8	 DM65-17	 DM65-26	 DM65-35	 DM65R-35	 DM65-44
	 DM65-9	 DM65-18	 DM65-27	 DM65-36	 DM65R-36	 DM65-45



74

PER / FOR

**DOMINION** (US)  
PETERBORO  
+ ARROW (20)

**DOMUS** (IT)  
+ CAS-CISMA (45)

**DOMUS** (GR)

PER:  
FOR:

### DOMINION

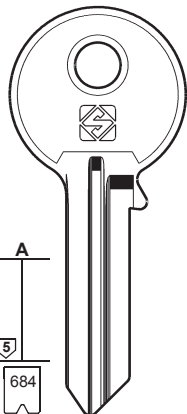

**DO1R**

1-2-3-4-5-6-7-8-9

PETERBORO

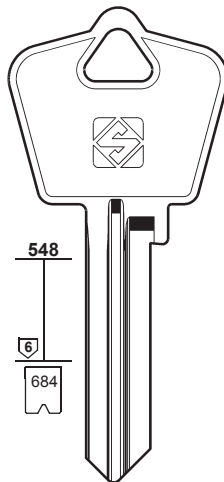

**DO2R**

1-2-3-4-5-6-7-8-9

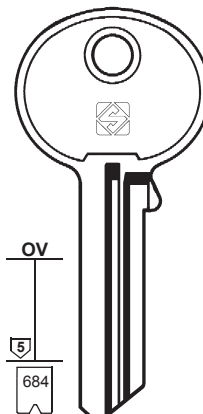

**DO6**

1-2-3-4-5-6-7-8-9

PER:  
FOR:

### DOMINION

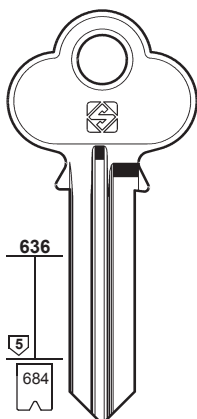

**DO10**

1-2-3-4-5-6-7-8-9

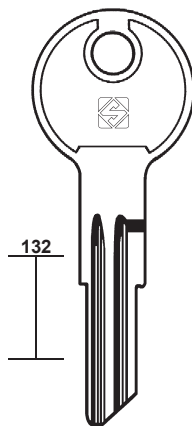

**DO11**

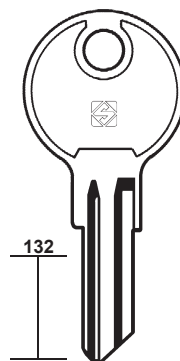

**DO12**

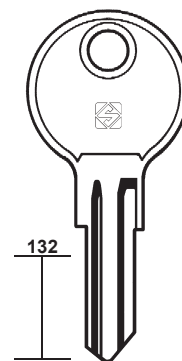

**DO13**



PER:  
FOR:

### DOMUS (IT)

### DOMUS (GR)

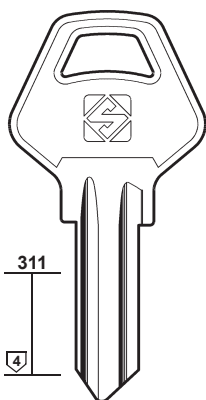

**DS4**

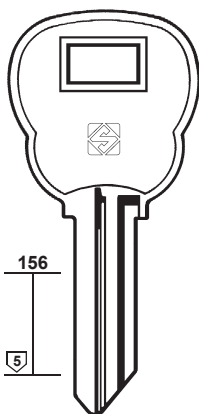

**DS1**



**DS1R**



**DS2**

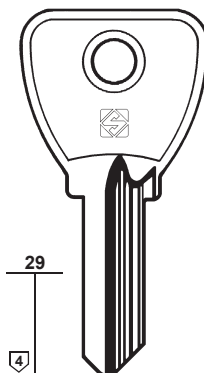

**DS3R**

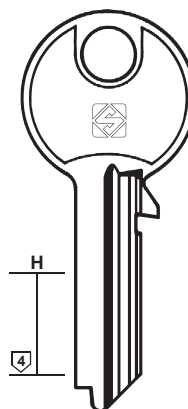

**DS5R**

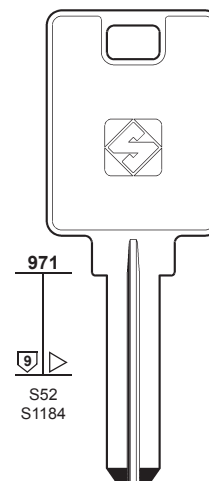







**DS6**

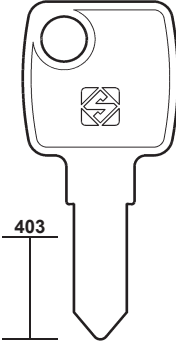
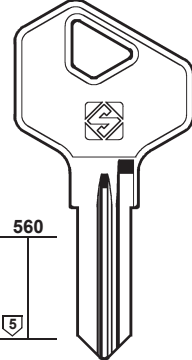
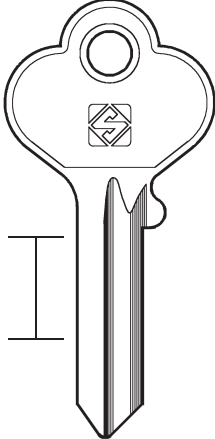
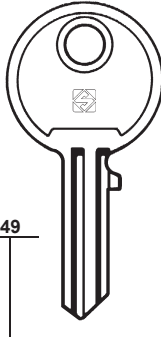

**DS7**









S52  
S1184

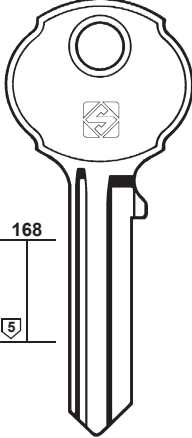
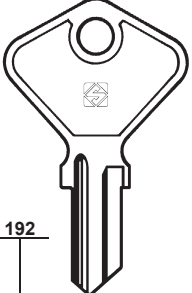
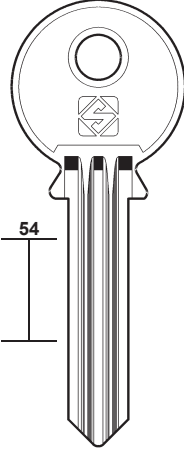
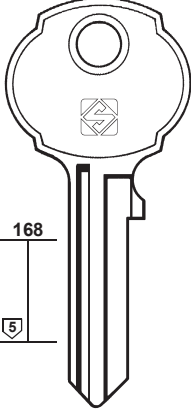

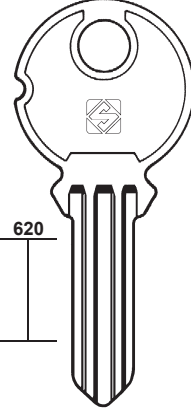





PER: FOR:	DONG HWA	DORIC	DORSET	DOUBLE ARROWS
	 403	 560 5	 5	 49
	 DOW1R	 DRC1	 DRS1R	 DW1 

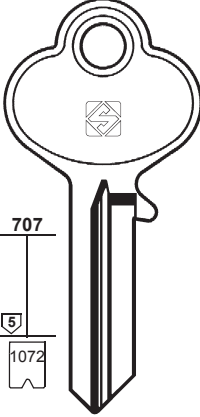
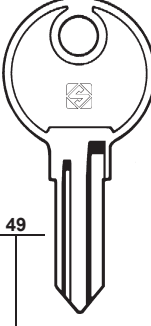
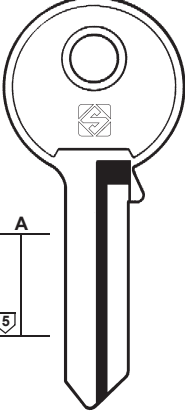
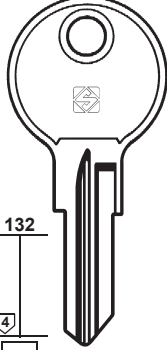

75

PER: FOR:	DOUBLE CIRCLE	DIPLOMATIC	EAG
	 168 5	 192	 54
	 168 5	 DP1 DP1R	 620
	 DCR1		 EA1
	 DCR2		 EA2
			 EA3
			 EA4
	TRI-CIRCLE		

PER: FOR:	EAGLE	EAST	ECM
	 707 5 1072	 49	 A 5
	 132 4 1045	 EAS1	 ECM1
	 EG1		 ECM1R
	 EG2		
	 EG2R		
	1A... EA... EB... EZ... PZ... 1-240		
	DNS - HARLOC - LORI		

PER / FOR
DONG HWA (TW)
DORIC (AU)
DORMA (DE) WILKA (210)
DORSET (IN) KABA (113)
DOUBLE ARROWS (TW)
DOUBLE CIRCLE (TW) TRI-CIRCLE
DOUBLE SAFE (GB) EURO LOCKS (79) L & F (128)
DUBOIS (FR) LAS (121)
DUO (US) ILLINOIS (107)
DIPLOMATIC (IT)
DYES (DE) DOM (70)
EAG (DE)
EAGLE (US) DNS HARLOC LORI
EAO (DE) DOM (68)
EAST (TW)
EBA (IT) MERONI (137)
ECM (PT)



# 76

PER / FOR

**EFCO** (AU)

**EGRET** (GR)

**EFSA** (FR)

**BABY-CLIP** (30)

**EGSA** (DE)

**TOK-WINKHAUS** (186-187)

**EIKO** (TW)

**CINA** (54)

**EKLA** (HK)

**GUARD** (100)

**ELCA** (DE)

STS  
TESA  
VIRO

**ELDON** (DE)

**EMKA** (77)

**ELEPHANT** (TW)

**TRI-CIRCLE** (189)

**ELFIN** (IT)

**CEMA** (46)

**ELKO** (CZ)

**ELMO** (US)

**BASCO** (31)

**ELP** (RU)

**ELSA** (IT)

**GIUSSANI** (96)

**ELSET** (FR)

**CLAUSOR** (59)

**ELSI** (IT)

**INDESIT** (107)

**ELVOX** (IT)

**GIUSSANI** (96)

**ELZETT** (HU)

TIEFENTHAL

+ **CES** (47)

**EMGE** (FR)

**RONIS** (161)

**EMHART** (US)

**CORBIN** (62)

**DOM** (70-71)

**RONIS** (161)

PER: **EFCO**

FOR:

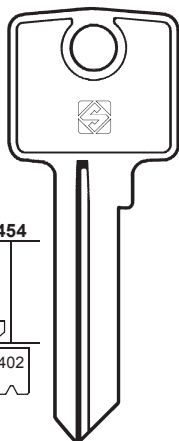

454

6

402

0-1-2-3-4-5-6-7-8-9



EF7



CA **EF1R**



CK **EF2R**



DA **EF3R**



DB **EF4R**



DK **EF5R**



DM **EF6R**

PER: **EGRET**

FOR:

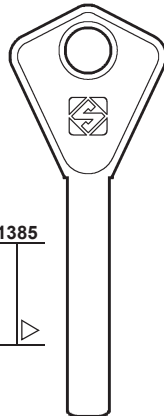

1385



EGR1

PER: **ELCA**

FOR:

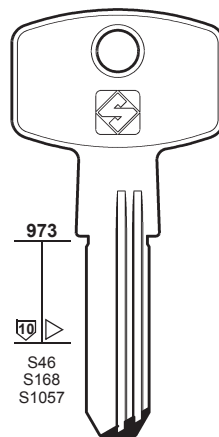

973

10

S46  
S168  
S1057



EC5



STS - TESA - VIRO

PER: **ELKO**

FOR:

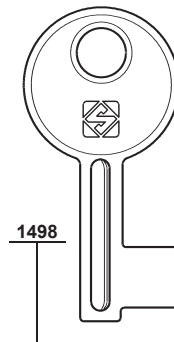

1498



ELK1

PER: **ELP**

FOR:

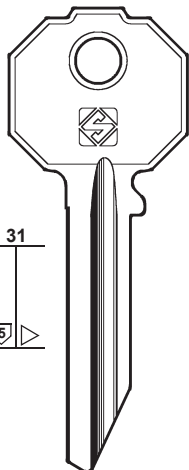

31

5



ELP1R

PER: **ELZETT**

FOR:

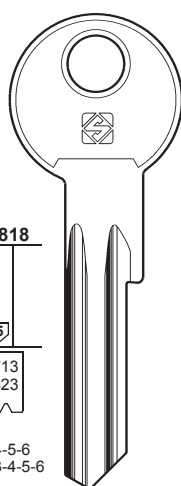

818

5

713  
823

1-2-3-4-5-6  
0-1-2-3-4-5-6



EL1X



TUTIS

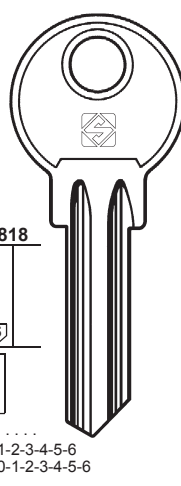

818

5

713  
823

1-2-3-4-5-6  
0-1-2-3-4-5-6



EL1



TIEFENTHAL

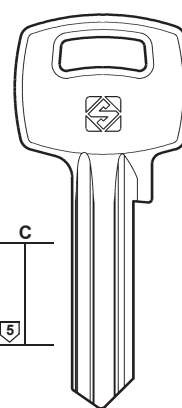

C

5



EL1C

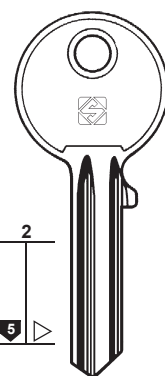

2

5



EL3

PER: **ELZETT**

FOR:

PER: **ELZETT**

FOR:

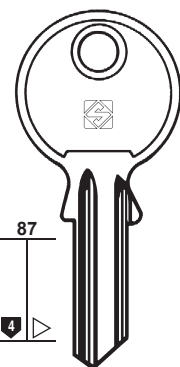

87

4



EL2

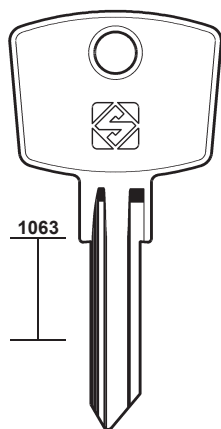

1063



EL4



EL6

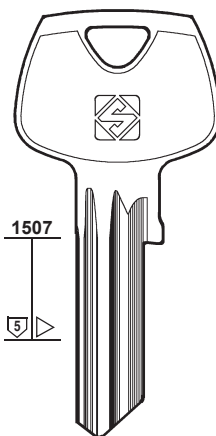

1507

5



EL5R



EL7R

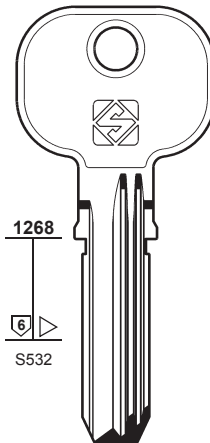

1268

6

S532

0-1-2-3-4



EL9



PER:  
FOR:

### EMKA

### EMR

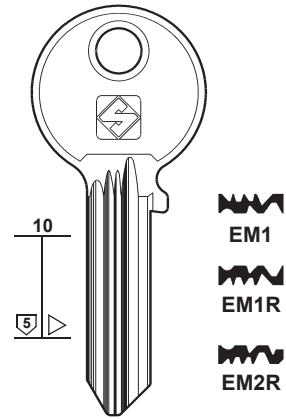
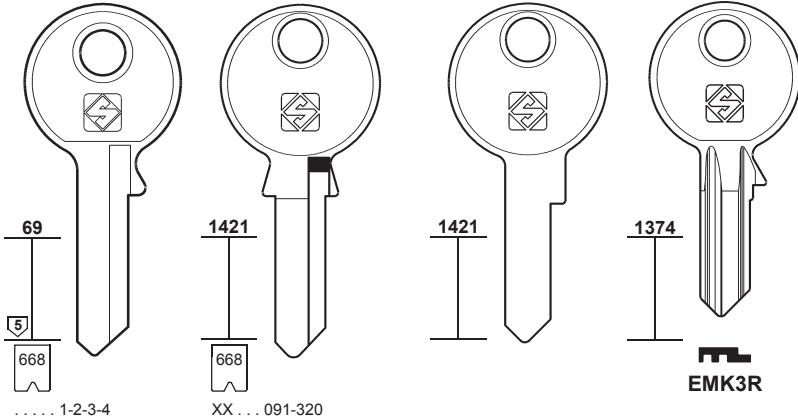

# 77

- PER / FOR**
- EMKA (FR)
    - ELDON
    - GHE
    - KOVER
    - RONIS
    - + EURO LOCKS (78)
    - + FORT (90)
    - + RONIS (161)
    - + TITAN (183)
    - + WILKA (210)

PER:  
FOR:

### EMR

### ENEL

### ERA

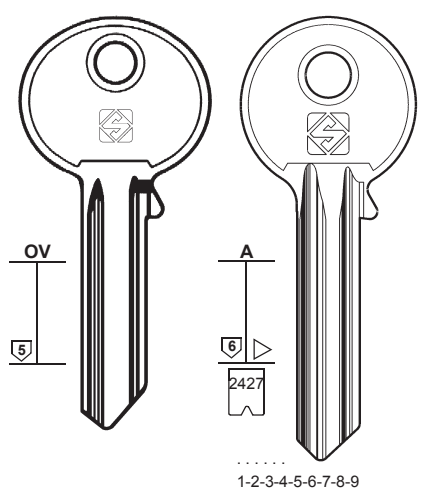
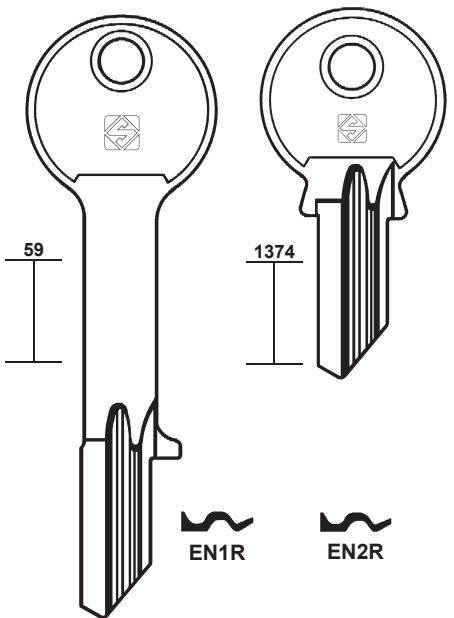
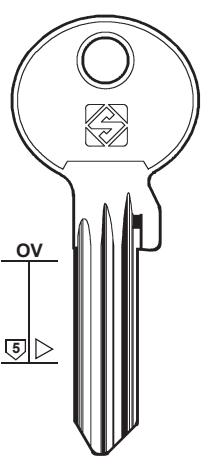

- EMR (DE)
  - DOM
  - GTV
  - JOWIL
  - TIEFENTHAL

- ENAX (FR)
  - TOK-WINKHAUS (187)

- ENEL (IT)
  - EPO (JP)
    - SCHLAGE (165)

- EQUIBATIR (FR)
  - RONIS (161)

- ERA (GB)
  - ERICSSON (SE)
    - TEKA (181)

- ERMEX (SE)
  - TEKA (181)

- ERTEL (DE)

- ESA (ES)
  - NUMIDIA

PER:  
FOR:

### ERA

### ERTEL

### ESA

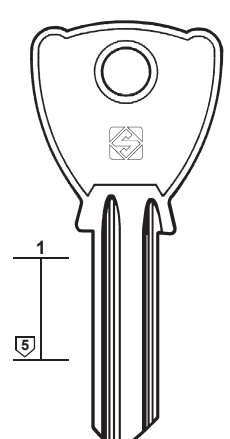
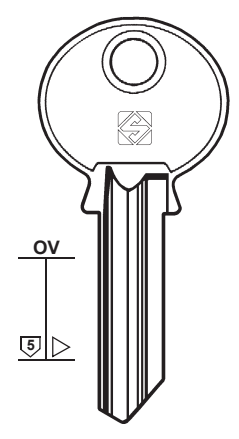
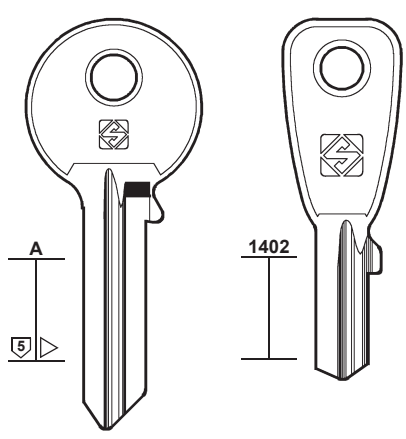

- ESAFE (ES)
  - EZCURRA (82)
  - TESA (181)
  - UCEM (192)

- ESCO (DE)
  - CISA (55)
  - CORBIN (60)

- ESLA (GB)
  - CISA (56)

- ESS (DE)
  - BAB (28)

- ESSENDIA (SE)
  - CISA (55)

- ESZ (DE)
  - JOWIL (110)



78

PER / FOR

ETAS (GB)  
YANEDIS

ETF (FR)  
+ BABY CLIP (30)

ETNA (IT)  
+ CAS-CISMA (45)

EUREKA (IT)  
ITALBLOCK

EUROBOX (GB)  
+ FORT (90)

EURO LOCKS (BE)  
FASMA  
L & F  
SCHULTZ  
+ BASTA (31)  
+ CHICAGO (52)  
+ L & F (128-129)

PER: FOR:	ETAS	ETF	ETNA
	 ETA1 YANEDIS	 ETF1	 ET1  ET1R  ET2  ET2R

PER: FOR:	EUREKA				EUROBOX
	 EK1	 EK1R	 EK2	 EK2R	 EK4
	 EK4R	 EK3	 EK3R	 EBX1R	
	ITALBLOCK				

PER: FOR:	EURO LOCKS		
	S928 S990  EU17	200 1435  EU3  EU11R K... 5272-6291	 EU12  EU1R ... 1201-1400 ... 45001-48000 ... 45001-49001 ... 43001-45000 ... 48001-49000 ... 50001-52000  EU19  EU5R ... 25001-27000 FASMA  EU18R
	SCHULTZ		L & F



PER:  
FOR:

## EURO LOCKS

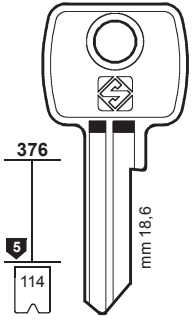

**LF4**      **LF4R**

60 ... 1-400  
90 ... 1-200  
92 ... 1-400  
... 1-400  
GHM ... 1-155  
M ... 1-400  
92 ... 401-600  
99 ... 1-400  
RV ... 1-400  
RVM ... 1-400  
SP ... 1-400  
GS ... 1-400  
... ES1  
... EV1

L & F

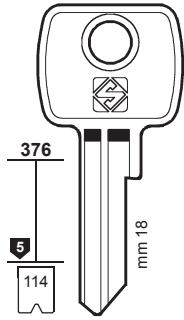

**LF6**      **LF6R**

90 ... 1-200  
... 1-400  
91 ... 201-275  
GH ... 1-400  
SS ... 1-400  
91 ... 276-350



**LF18R**

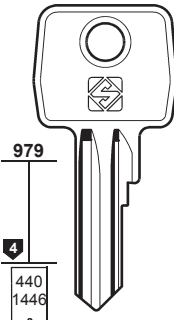

**EU4**      **EU4R**

... E 01234  
... E 1111-4444  
... 405-4324  
... E 405-4324



**EU2**



**EU2R**



**EU7**



L & F

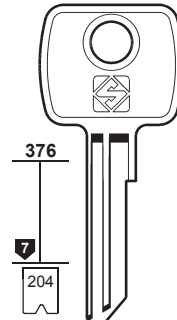

**LF11**      **LF11R**

76 ...  
1-400  
...  
70001-71000  
M ...  
70001-71000



# 79

PER / FOR

**EURO LOCKS (BE)**  
DOUBLE SAFE  
BASI  
IBFM  
L & F  
VIOMETAL  
+ BASTA (31)  
+ CHICAGO (52)  
+ L & F (128-129)

PER:  
FOR:

## EURO LOCKS

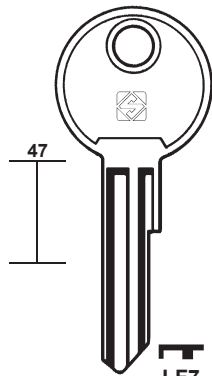

**LF7**



**LF8**



**LF8R**

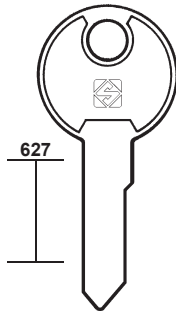

**LF29R**

L & F

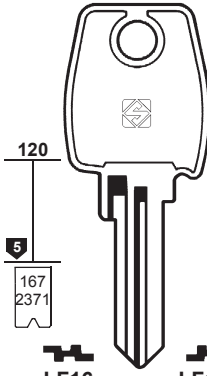

**LF16**      **LF16R**



**LF2**



**LF26**

G ... 1001-5000  
... 31001-32000  
... 32001-33000  
... 36001-38000  
... 38001-38999  
... 77001-77500  
... 95000-99000

DOUBLE SAFE

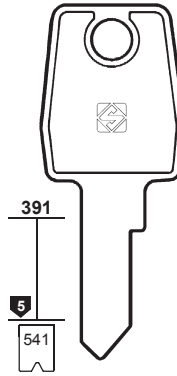

**LF13**



**LF17**



**LF15R**

90901-90975

L & F

PER:  
FOR:

## EURO LOCKS

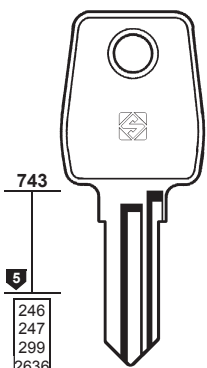

**LF22**      **LF22R**

93 ... 201-400  
... 93901-94000

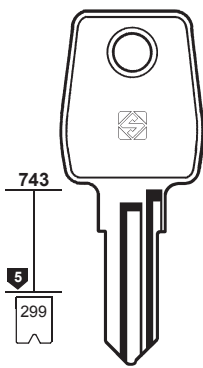

**LF20**      **LF20R**

93901-94000

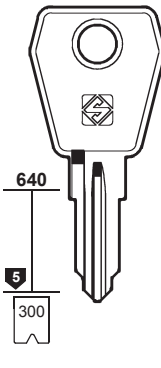

**LF30R**

... 801-900  
... 901-1000  
... 901-1000  
IBFM



**EU9**

BASI - L & F  
VIOMETAL

**EU16R**

L & F

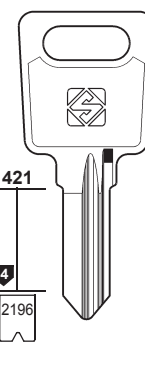

**EU14**

IF ... 1-2-3-4



80

PER / FOR

EURO LOCKS (BE)

DETHLEF  
HOBBY  
KNAUS  
TRABER  
+ \* BASTA (31)  
+ \* CHICAGO (52)  
+ \* L & F (128-129)

EURONORM (DE)

\* CORBIN (60)  
\* CORNI (62)

EUROP (FR)

\* SUREX (178)

EURO PLUS (CZ)

EUROSPEC (GB)

EVERGOOD (TW)

JNF  
MERONI  
SISO

EVO (GB)

MILA

EVVA (AT)

TRYBA

PER: FOR:	EURO LOCKS	EURO PLUS	EUROSPEC	EVERGOOD
	 3 55 2196 298 3982 EU20 ..... 12345 EU15 EU6 EU10 EU10R ..... 2001-2200 DETHLEF - HOBBY KNAUS - TRABER	 1241 EUR1	 1329 2690 EUS1 ..... 123456	 625 ED1 

PER: FOR:	EVERGOOD	EVO	EVVA
	 48 3344 ED2 MERONI ..... 1-2-3 ED4 ED3R JNF - SISO	 A EVO1 MILA	 54 360 441 666 1537 ..... A 1000-9999 ..... A . 1000-9999 ..... A . 1000-9999 ..... A ... 1000-9999 ..... 1234567890 ..... 1234567890 XA ..... 40000-59999 A ..... 5600-9999 ..... 60001-97000 ..... C 1000-9999 ..... C . 1000-9999 ..... C ... 1000-9999 ..... C .... 1000-9999 ..... (.) 1234567890 C ... 5600-9999 C ..... 60001-97000 EV2 E EV3 C EV4 F EV5 Z EV9 BB EV10 A EV3R 2C EV4R 2F ..... Z 1000-9999 ..... Z . 1000-9999 ..... Z ... 1000-9999 ..... Z .... 1000-9999 Z ..... 5600-9999 ..... F 1000-9999 ..... F . 1000-9999 ..... F ... 1000-9999 ..... F .... 1000-9999 F ..... 5600-9999

PER: FOR:	EVVA			
	 54 666 EV110RX EV118X EV3X C EV4X F EV5X Z EV2X E EV69X S EV111RX EV3RX 2C EV4RX 2F EV9X BB EV10X1 A EV64RX S	 OV 666 EV10X A ..... 60001-97000	 471 666 EV11 C EV12 A	 54 361 666 EV81X 6S ..... 40000-59999 EV109X EV82X

TRYBA

PER:  
FOR:

# EVVA

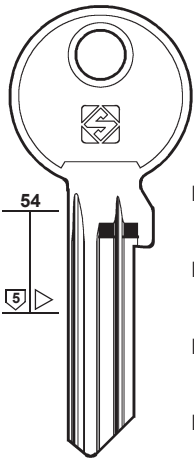

**EV103X-1**

**EV103X-2**

**EV103X-3**

**EV103X-4**

**EV103X-5**

**EV103X-6**

**EV103X-7**

**EV103X-8**

**EV103X-9**

**EV103X-10**

**EV103X-11**

**EV103X-12**

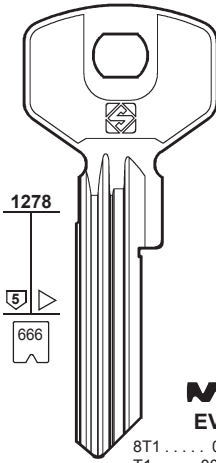

**EV70**

8T1 ..... 00000-99999  
T1 ..... 00001-68199  
T1 ..... 68200-99999

**EV70R**

OT1 ..... 00000-99999  
OT ..... 00001-83799  
OT ..... 83800-99999

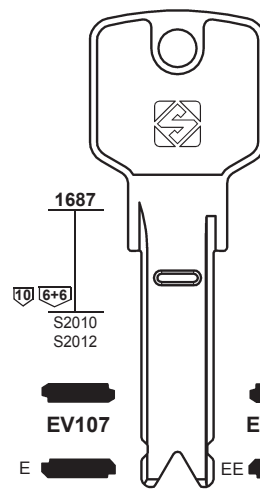

**EV107**

S2010  
S2012

**EV106**

**EV122**

**EV107R**

**EV106R**

**EV122R**



# 81

PER / FOR

**EVVA (AT)**

**EXCEL (FR)**  
+ **SIDLEEN (169)**

**EXPRES (PL)**  
 **LOB (125)**

**EXCEL (FR)**  
+ **SIDLEEN (169)**

**EXPRES (PL)**  
 **LOB (126)**

**EZCURRA (ES)**  
+ **SEA (166)**

PER:  
FOR:

# EVVA

# EXCEL

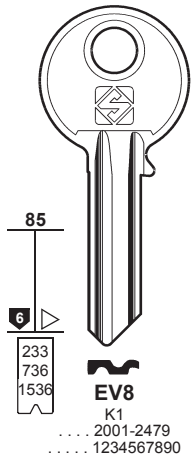

**EV8**

K1  
..... 2001-2479  
..... 1234567890

**EV8R**

K0  
..... 1001-1479  
..... 1234567890

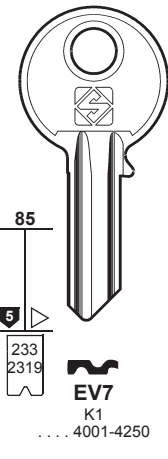

**EV7**

K1  
..... 4001-4250

**EV7R**

K0  
..... 3001-3250  
M ..... 3001-3250

**EV21R**  
NM .....  
NM2 .....  
50000-54999

**EV22R**  
NM .....  
NM2 .....  
55000-59999

**EV23R**  
NM .....  
NM2 .....  
60000-64999

**EV24R**  
NM .....  
NM2 .....  
65000-59999

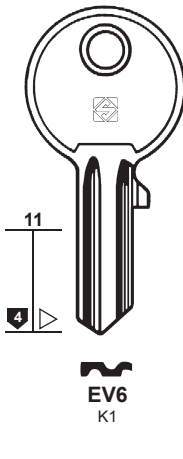

**EV6**

K1

**EV6R**

K0

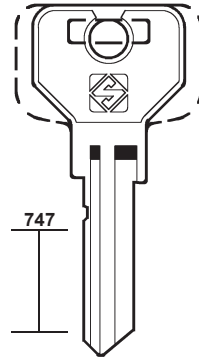

**EX1**

PER:  
FOR:

# EZCURRA

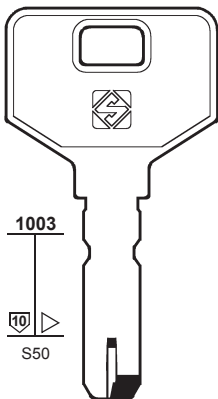

**EZ3**  
DS10

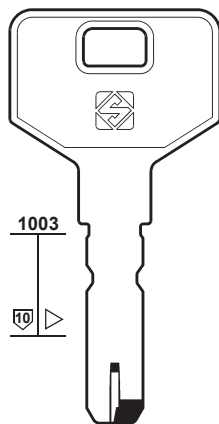

**EZ3X**  
DS10

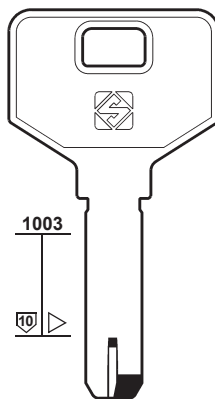

**EZ6**  
DS15

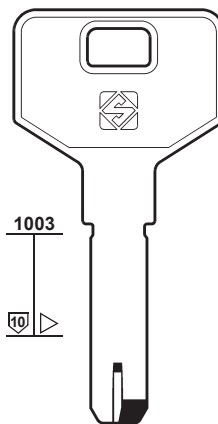

**EZ6X**  
DS15





82

PER / FOR

**EZCURRA (ES)**

ESAFE  
JMR  
NAZABAL  
+ SEA (166)

**E-Z-SET (US)**

KWIKSET (119)

**FAB (CZ)**

GUARD  
LOB  
YETI

PER:  
FOR:

**EZCURRA**

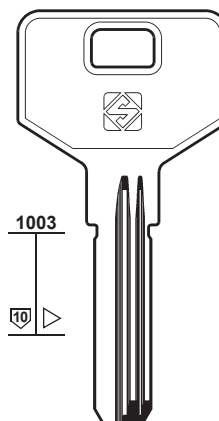
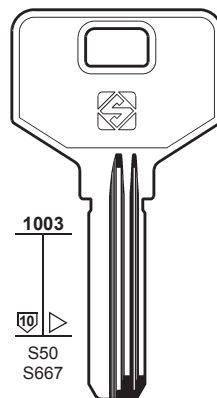
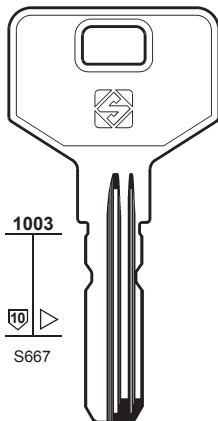
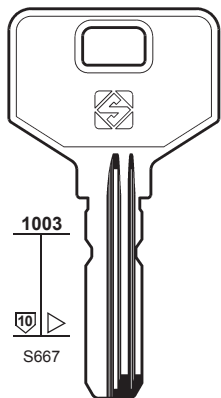

PER:  
FOR:

**EZCURRA**

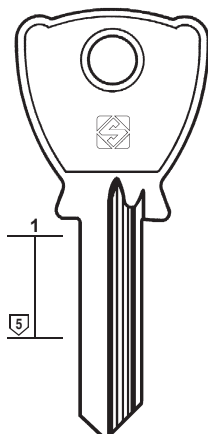

NAZABAL

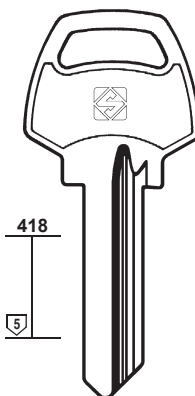

ESAFE - JMR

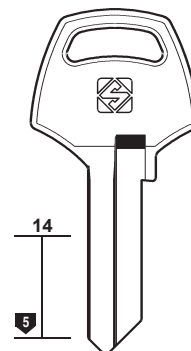

PER:  
FOR:

**FAB**

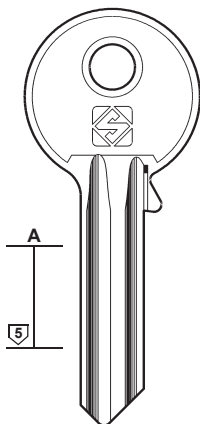

GUARD

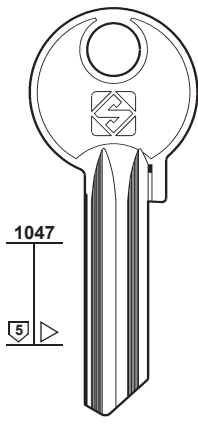

GUARD

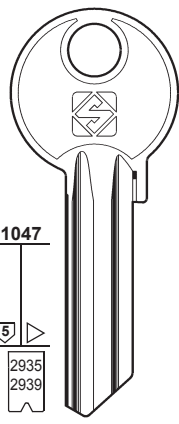

LOB - YETI

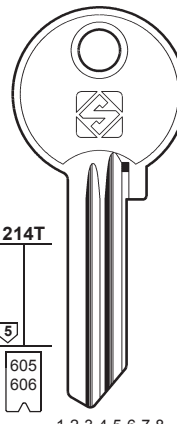

15



..... 1-2-3-4-5-6-7-8  
..... 0-1-2-3-4-5-6-7-8



16

PER:  
FOR:

**FAB**

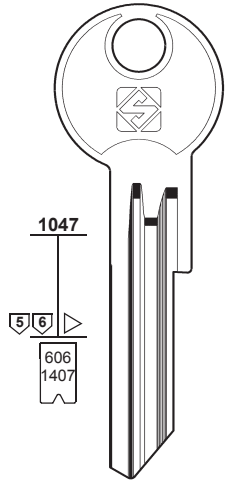

..... 0-1-2-3-4-5-6-7-8  
..... 0-1-2-3-4-5-6-7-8

- |            |           |           |           |           |            |            |            |            |        |       |            |            |            |            |       |
|------------|-----------|-----------|-----------|-----------|------------|------------|------------|------------|--------|-------|------------|------------|------------|------------|-------|
| FB98X      | FB62X     | FB63X     | FB13X     | FB13RX 20 | FB14RX 21  | FB15RX 22  | FB16RX 23  | FB97RX     | FB69RX | FB39X | FB21RX 10X | FB22RX 11X | FB25RX 12X | FB28RX 14X | FB20X |
| FB62RX 030 | FB17RX 24 | FB18RX 26 | FB19RX 30 | FB20RX 32 | FB21RX 10X | FB22RX 11X | FB25RX 12X | FB28RX 14X | FB20X  |       |            |            |            |            |       |

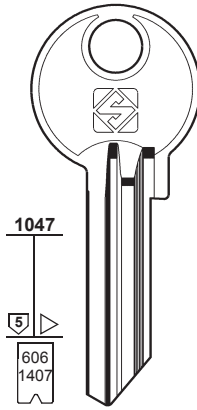

..... 0-1-2-3-4-5-6-7-8  
..... 0-1-2-3-4-5-6-7-8

- |       |          |          |          |          |          |          |          |       |       |           |           |           |           |
|-------|----------|----------|----------|----------|----------|----------|----------|-------|-------|-----------|-----------|-----------|-----------|
| FB17X | FB13R 20 | FB14R 21 | FB15R 22 | FB16R 23 | FB17R 24 | FB18R 26 | FB19R 30 | FB27R | FB57R | FB21R 10X | FB22R 11X | FB25R 12X | FB28R 14X |
|-------|----------|----------|----------|----------|----------|----------|----------|-------|-------|-----------|-----------|-----------|-----------|



**83**

PER / FOR

FAB (CZ)

PER:  
FOR:

**FAB**

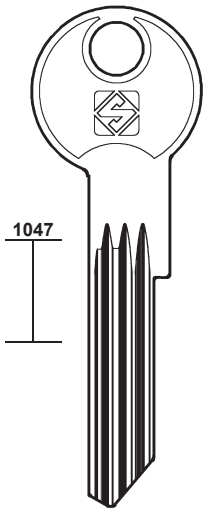

- |            |       |
|------------|-------|
| FB64RX 027 | FB64X |
|------------|-------|

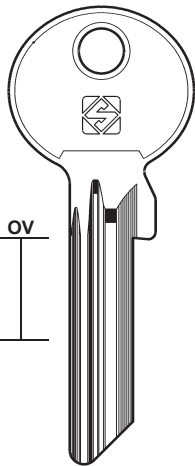

- |         |
|---------|
| FB35R K |
|---------|

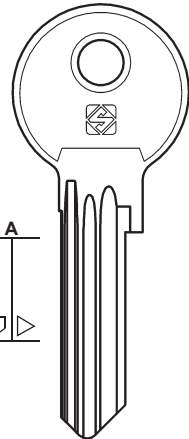

- |       |
|-------|
| FB108 |
|-------|

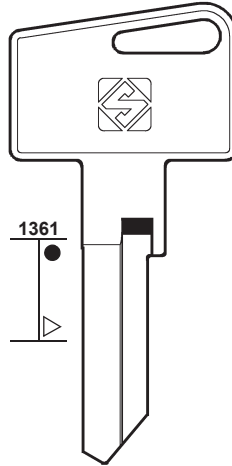

- |      |
|------|
| FB31 |
|------|

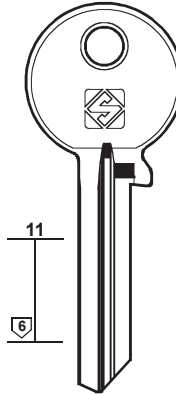

- |       |
|-------|
| FB65R |
|-------|

PER:  
FOR:

**FAB**

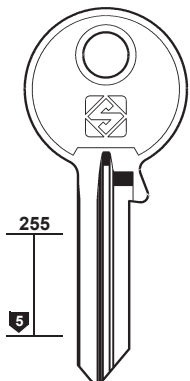

- |       |
|-------|
| FB34R |
|-------|

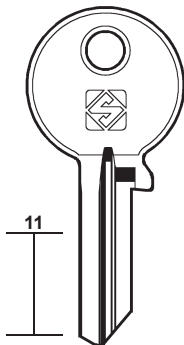

- |            |
|------------|
| FB83R 82KR |
|------------|

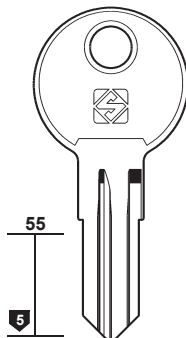

- |      |       |
|------|-------|
| FB36 | FB36R |
|------|-------|

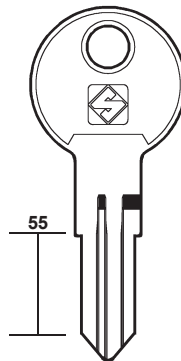

- |       |
|-------|
| FB103 |
|-------|

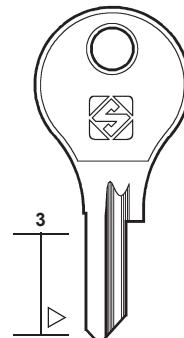

- |        |
|--------|
| FB105R |
|--------|

- |       |
|-------|
| FB75R |
|-------|

- |        |
|--------|
| FB104R |
|--------|





84

PER / FOR

FAC (ES)  
ARREGUI  
INDAUX

PER:  
FOR:

FAC

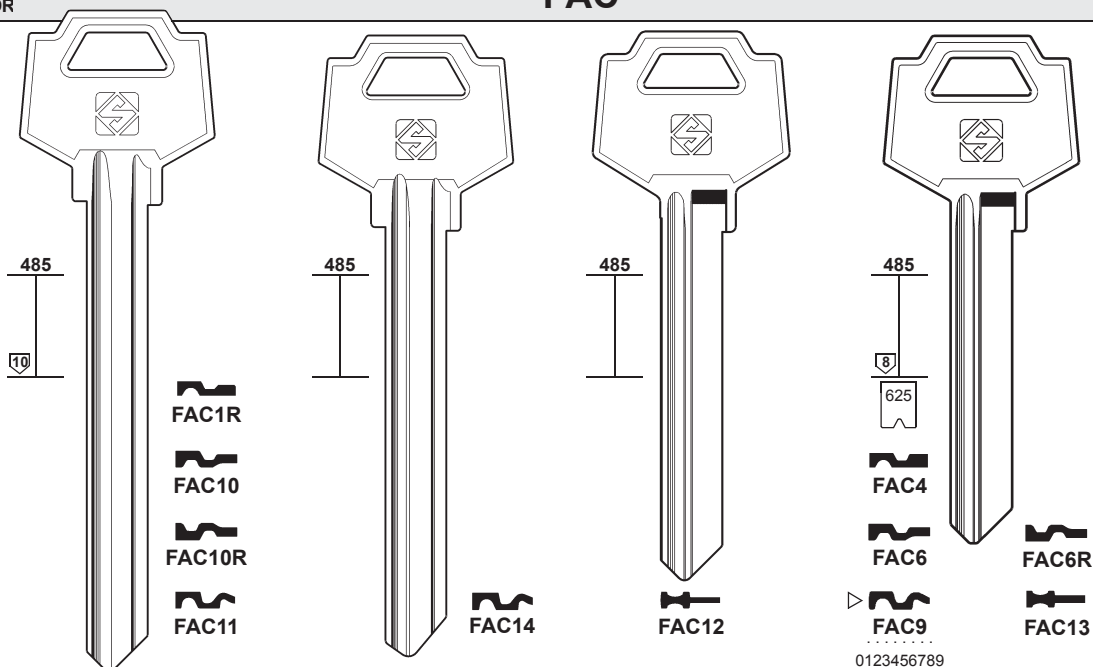

PER:  
FOR:

FAC

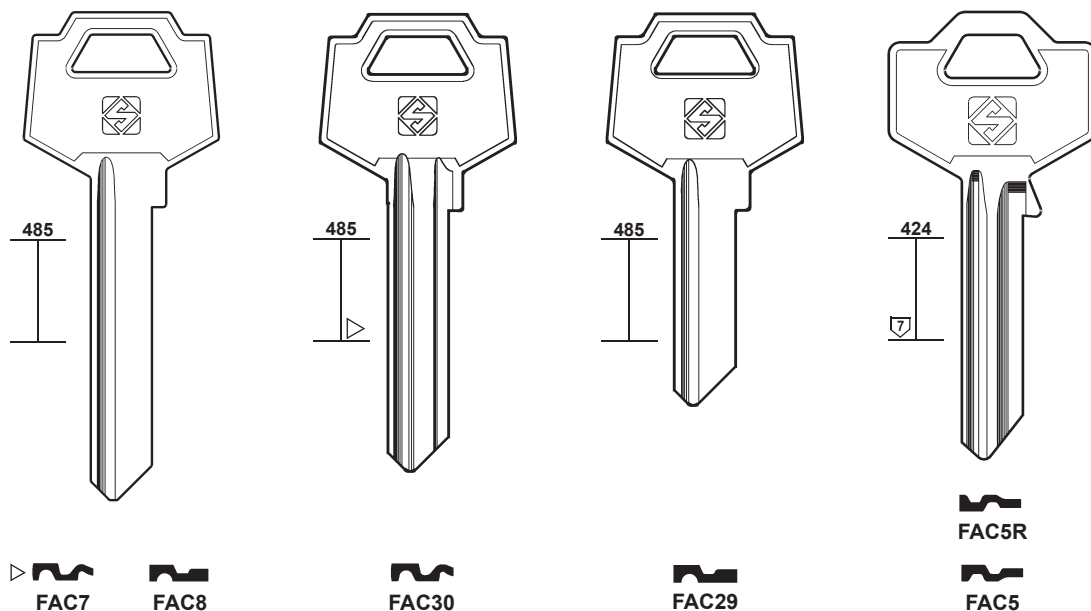

PER:  
FOR:

FAC

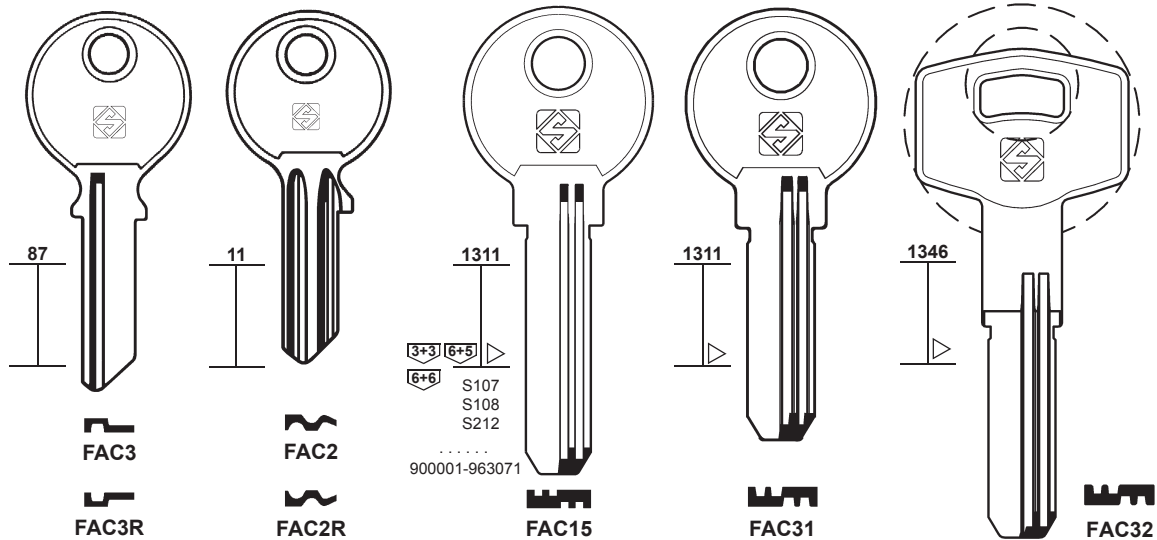

ARREGUI - INDAUX



PER:  
FOR:

### FAI

### FALCON



# 85

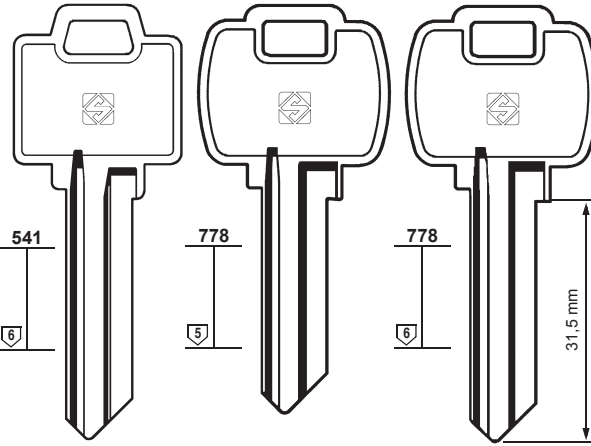
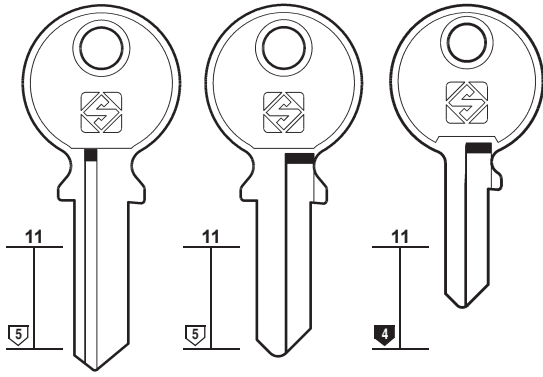

FAI1R

FAI2

FAI3

FN1

FN2

FN4



VIRO



VIRO

WEISER

WEISER

#### PER / FOR

**FAI (IT)**  
VIRO  
+ VIRO (205)

**FALCON (US)**  
WEISER  
+ BEST (33)  
+ WEISER (208)

**FAMA (IT)**

**FAMA (BR)**

**FANA (PL)**  
+ BRUMME (40)

**FARCE (FR)**  
 MELSMETALL (136)

**FAS (SE)**

PER:  
FOR:

### FAMA (IT)

### FAMA (BR)

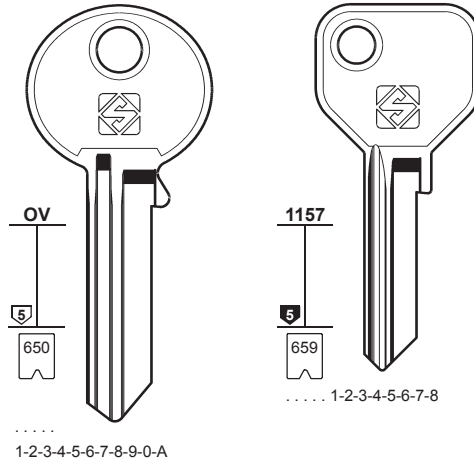
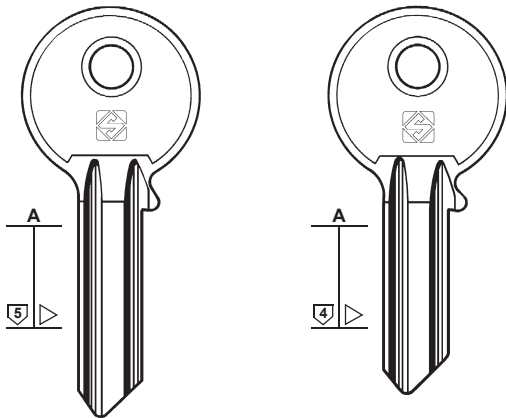

FAM1 FAM1R

FAM2 FAM2R

FAM6

FAM3

PER:  
FOR:

### FAMA (BR)

### FANA

### FAS

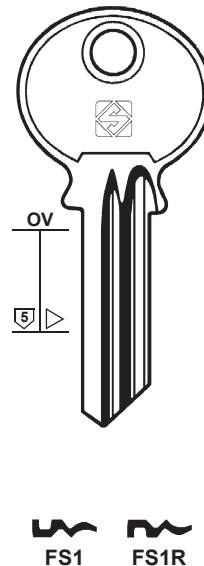
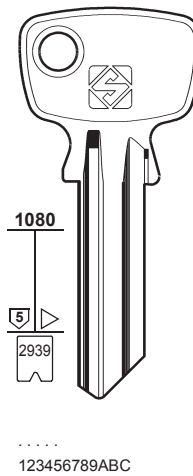
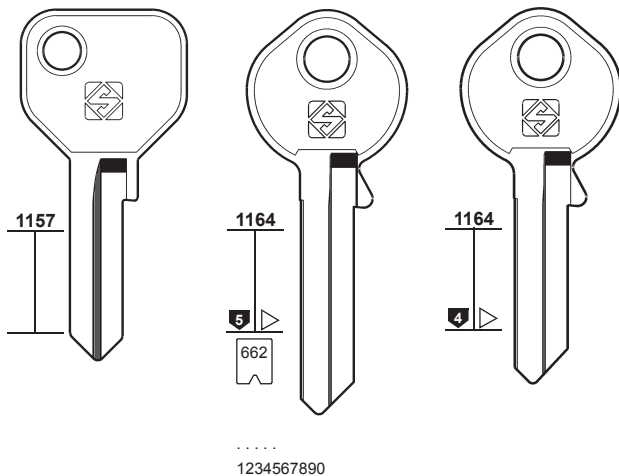

FAM9

FAM5

FAM8

FAN1

FS1 FS1R



86

PER / FOR

**FASEM** (IT)  
BERETTA  
BV  
FPB  
ILS  
IULIA MAS FED  
JUWEL  
+ **BIELLE** (33)

**FASMA** (IT)  
 **EURO LOCKS** (78)

**FATTORINI** (IT)  
 **PREFER** (157)

**FAVOUR** (DZ)

**FAYN** (TR)

**FB** (ES)  
 **AGA** (11)

**FBC** (IT)  
 **GIUSSANI** (96)

PER:  
FOR:

**FASEM**

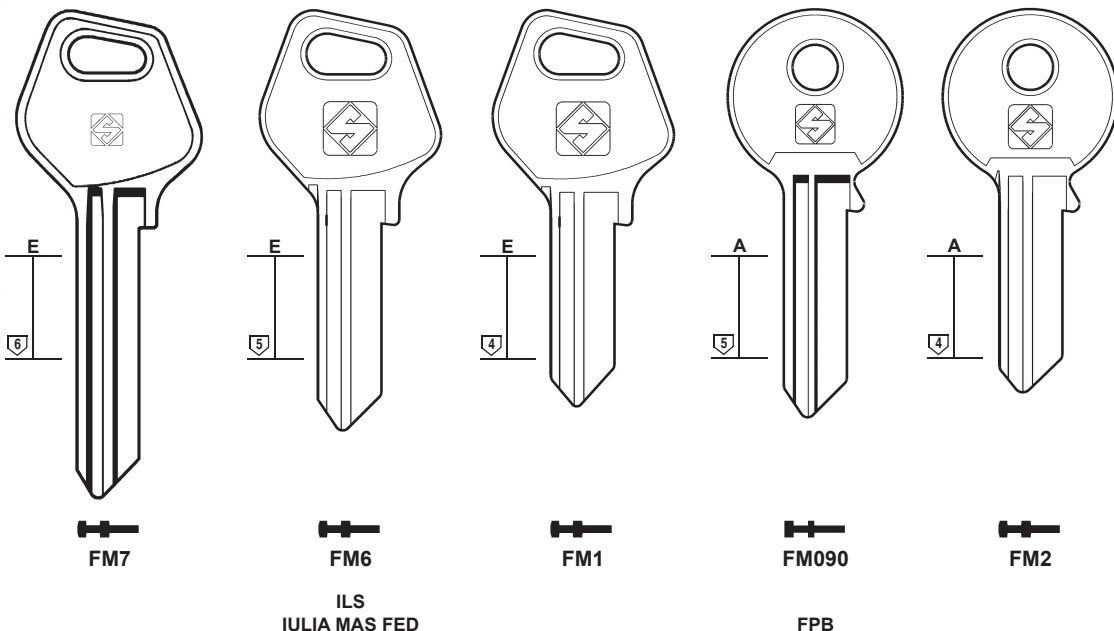

PER:  
FOR:

**FASEM**

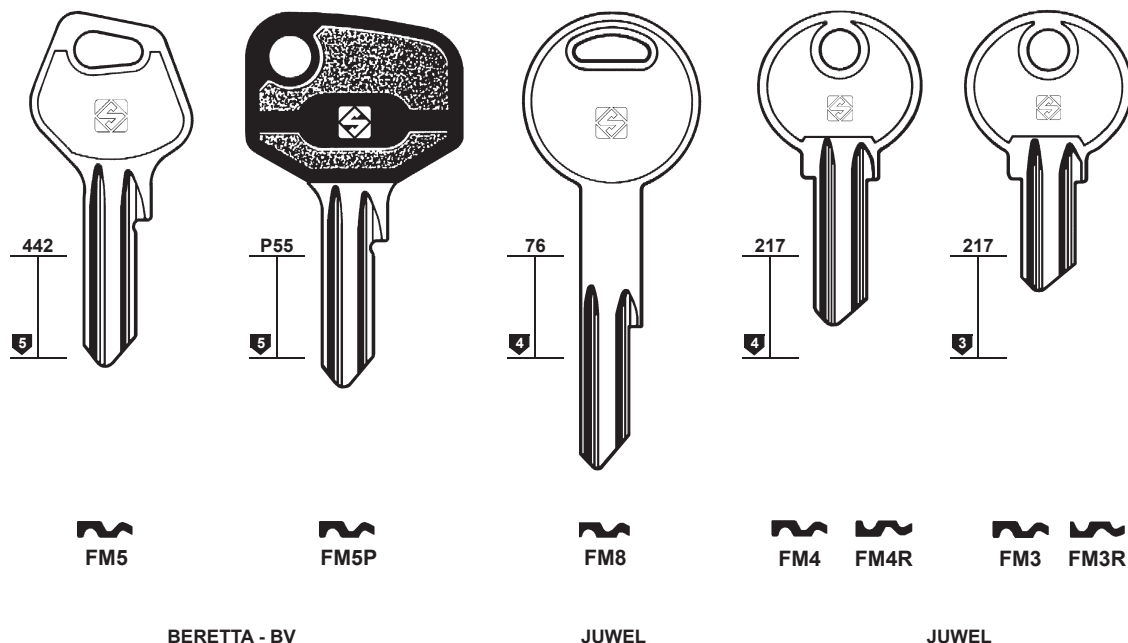

PER:  
FOR:

**FAVOUR**

**FAYN**

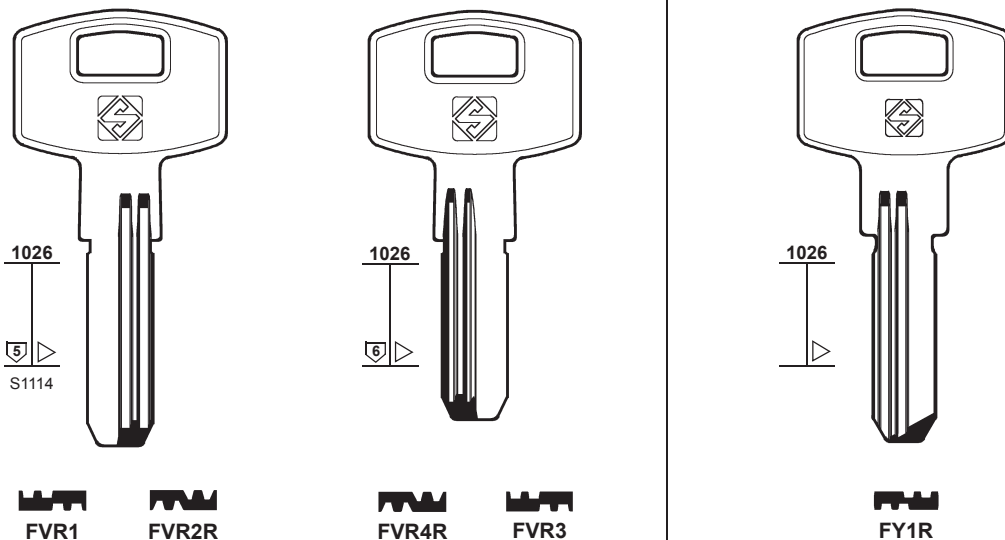



PER:  
FOR:

### FCV

### FEB

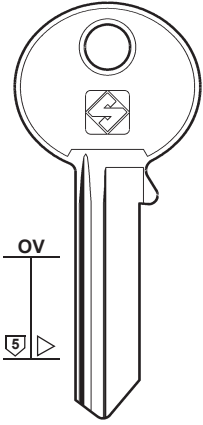

FCV1

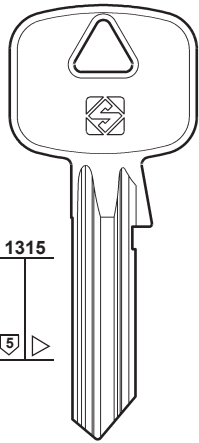

FCV2

KFV

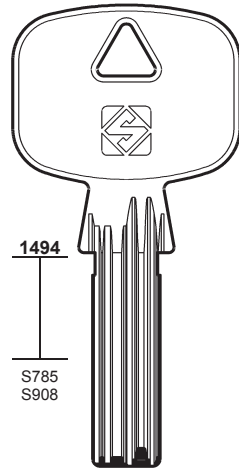

FCV4



KFV - VBH

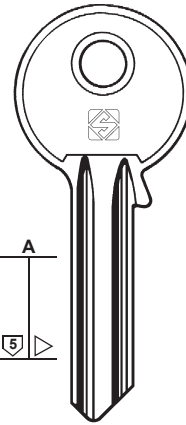

FEB2



FEB2R



# 87

#### PER / FOR

**FCV** (DE)  
KFV  
VBH  
+ KFV (116)

**FEB** (IT)  
+ ALPHA (16)  
+ CORBIN (60)  
+ JVAL (112-113)  
+ MORI E. (142)  
+ P.C. (CORTELLEZZI) (153-154)  
+ VIRO (205)

**FEDERAL** (FR)  
+ FTH (91-92)  
+ JUNKUNC (112)

**FEFI** (DE)  
 CES (47)

**FEL** (DE)  
 SIS (170)

**FERCO** (FR)  
 YALE (214)

**FERMABLOCK** (IT)  
 OLIVA (148)

**FERONERIA** (RO)

**F.F.** (IT)  
GUARDIAN

PER:  
FOR:

### FEB

### FEDERAL

### FERONERIA

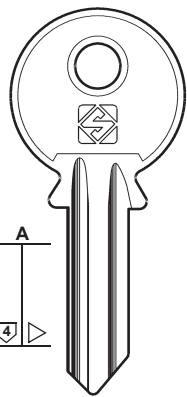

FEB1



FEB1R

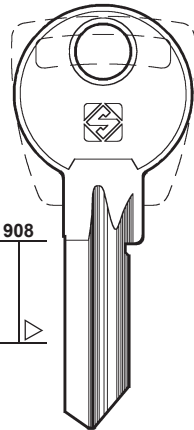

FEB6R

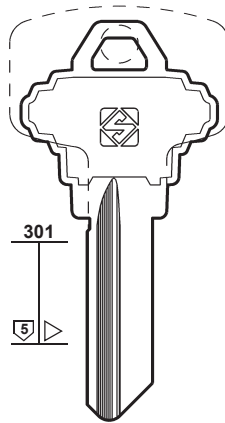

FDR1

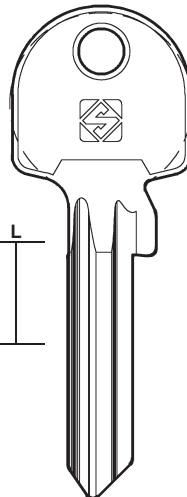

FDR2

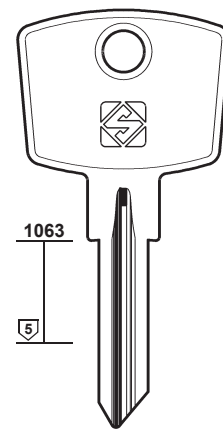

FRN1R

PER:  
FOR:

### F.F.

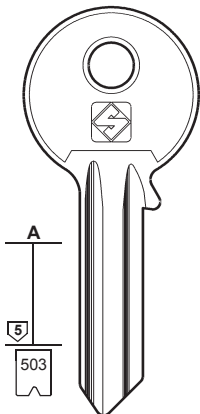

FF1



FF1R

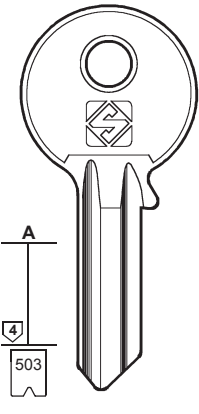

FF2

.....0-1-2-3-4-5-6-7

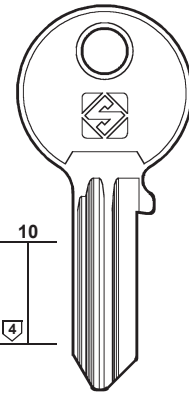

FF15

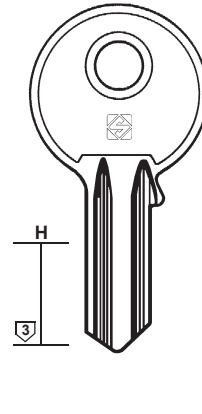

FF3



FF3R

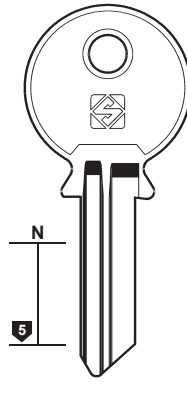

FF14



FF8



FF8R



FF9



FF9R



FF10



FF10R



FF17



FF7



FF7R

GUARDIAN

GUARDIAN



88

PER / FOR

F.F. (IT)

FIAM (IT)

+ KESO (116)

FIC (SA)

+ ZANI (220)

PER:  
FOR:

F.F.

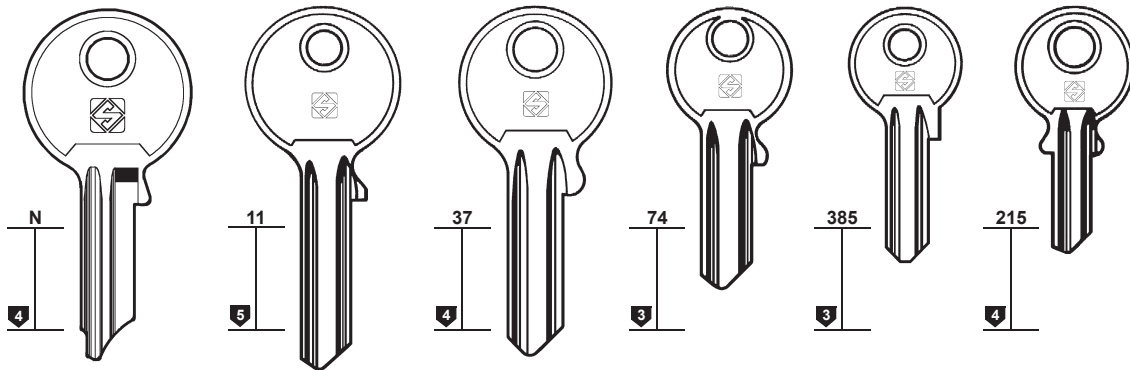

FF18

FF4

FF4R

FF12

FF12R

FF5

FF13

FF6

FF11

FF11R

FF5R

FF13R

FF6R

PER:  
FOR:

F.F.

FIAM

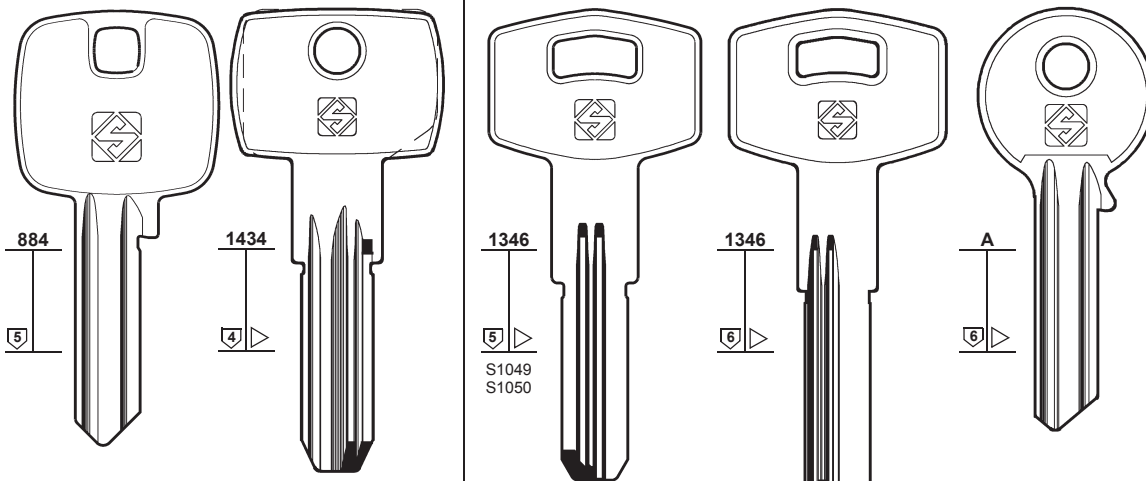

FF16

FF19

FI3R

FI4R

FI6

PER:  
FOR:

FIAM

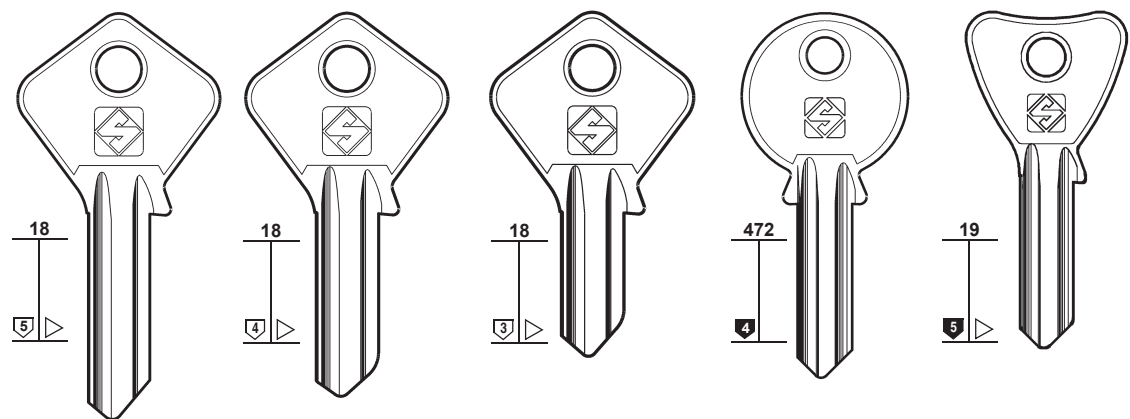

FI1

FI234

FI235

FI232

FI233

FI1R

FI2

FI064

FI065

MORI E.

PER:  
FOR:

# FICHET

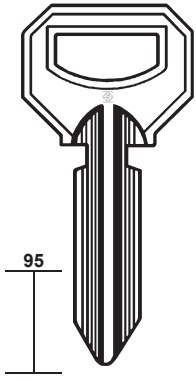

TECNOR

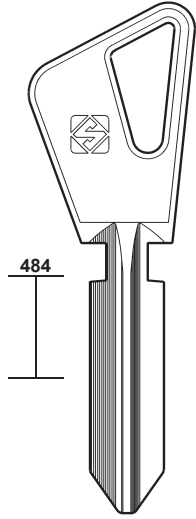

FT4



SURFINOR

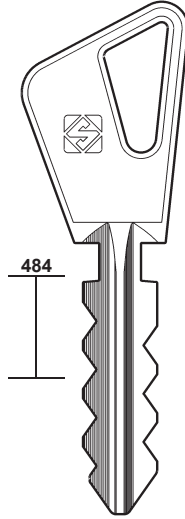

FT4C



SURFINOR

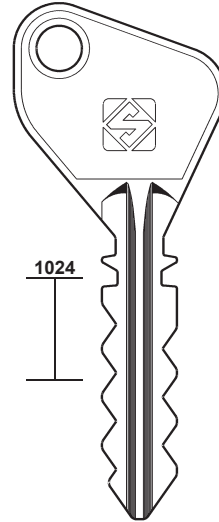

FT5C



# 89

PER / FOR

FICHET (FR)  
SURFINOR  
TECNOR  
+ TOK-WINKHAUS (187)

FIMANEVSKI (RU)  
DNEPROPETROVSK  
(67)

FIRMADOOR (AU)

FIRST (CH)

FIS (IT)

PER:  
FOR:

# FICHET

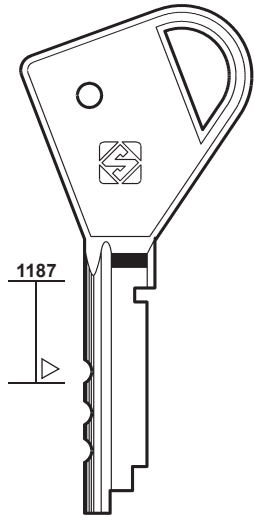

FT15R

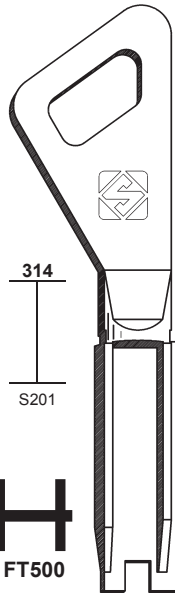

FT500

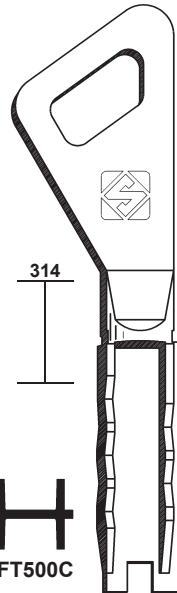

FT500C

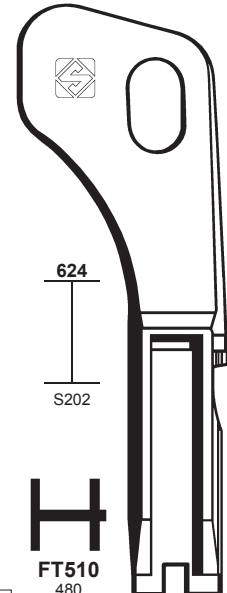

FT510  
480



PER:  
FOR: FIRMADOOR

# FIRST

# FIS

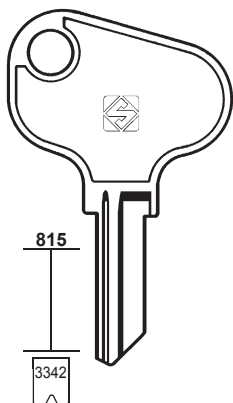

FID1  
B... 1-100

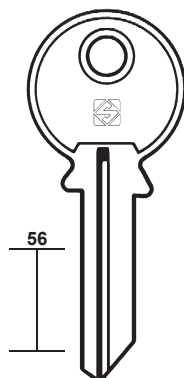

FIR1

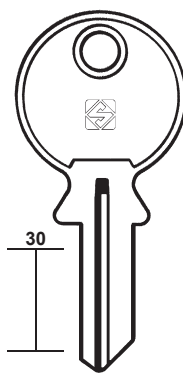

FIR1R

FIR3

FIR2R

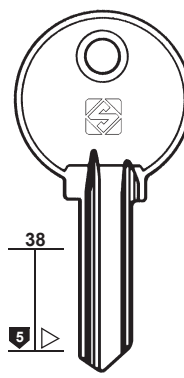

F1

F1R

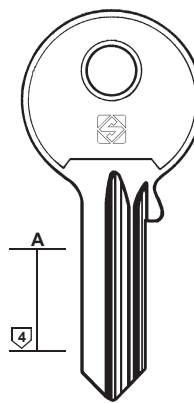

F2R



90

PER / FOR

FIST (IT)

FLAMBO (DE)

DOM (69)

FLIETHER (DE)

KFV (116)

FLIK (DE)

+ GEGE (93)

FLIM (RU)

FLOHR (DE)

FLORA (90)

FLORA (DE)

FLOHR

NB

NORDWEST

SUKI

FO (FR)

CITY (58)

MONOBLOC (141)

ZENITH (222)

FONDAR (IT)

OT

FONTAINE (FR)

CORNI (62)

RONIS (161)

VACHETTE (199)

FORINDEX (FR)

RONIS (161)

FORT (US)

ARFE

DAD

DECAYEUX

EMKA

EURO BOX

HUDSON

SECURITAL

UTZ

+ ABUS (9)

+ ARROW (20)

+ CHICAGO (51-52)

+ LAS (122)

FORTIS (ES)

LBLM

FORTSCHRITT (DE)

DOM (70)

ZEISS-IKON (221)

FOSAM (IT)

PREFER (157)

FOUR-CIRCLE (TW)

YETI (218-219)

FPB (IT)

FASEM (86)

P.C

CORTELLEZZI (153)

FRAL (PT)

P.C.

CORTELLEZZI (153)

FRANZEN (US)

FRANZMAR (BR)

FRECOV (DE)

CES (47)

FTH (F)

PER: FOR:	FIST	FLIK	FLIM	FLORA
	 20	 47	 54 5	 P419
	 FIS1R	 FIS1	 FIS3	 FK1
				 FL2
				 FL2R
				FLOHR - NB NORDWEST - SUKI

PER: FOR:	FONDAR	FORT					
	 327	 132	 743	 1171	 625	 1135	
	 FD1	 FRT1	 FRT4R	 FRT5R	 FRT7	 FRT8	
		H ... 6001-6250 RM ... 7001-7200	... 1-500 ... 9001-9500		... 501-600	... 601-700	
	OT	HUDSON	DAD - DECAYEUX EMKA - EURO BOX SECURITAL - UTZ		ARFE	DAD	

PER: FOR:	FORTIS	FRANZEN	FRANZMAR		FTH
	 1201	 55	 1428	 1553	 388
	 FOS1	 FRE1R	 FRZ1	 FRZ2	 FH7
	LBLM				

PER:  
FOR:

### FTH

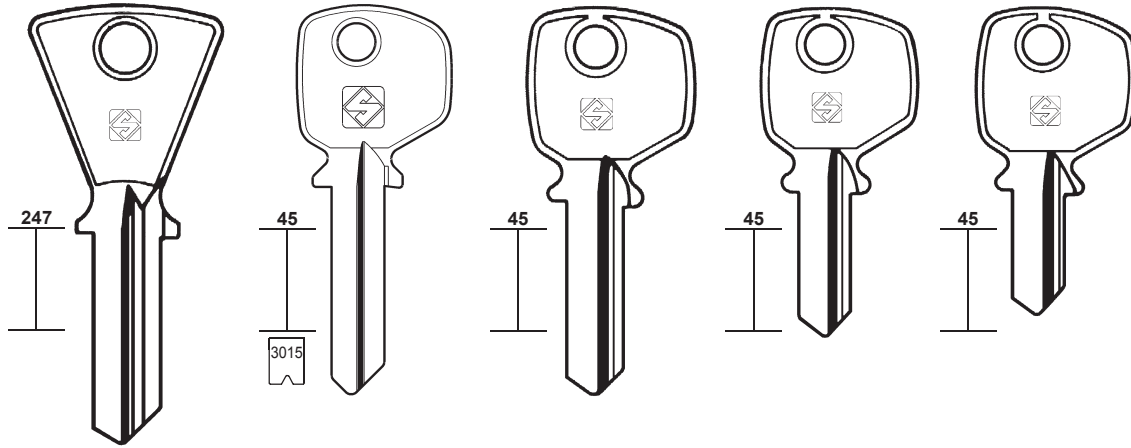

# 91

PER / FOR

### FTH (FR)

- CF
- CIB
- CIBC
- CITY
- DIAMA
- FEDERAL
- GISS
- GPR
- HUNIT
- IFAM
- JL
- NICO
- PICARDIE
- PROBAT
- SAMA
- SUF

- + ABUS (8)
- + BRUMME (40)
- + CAS-CISMA (45)
- + GLOBE (97)
- + TITAN (183)

PER:  
FOR:

### FTH

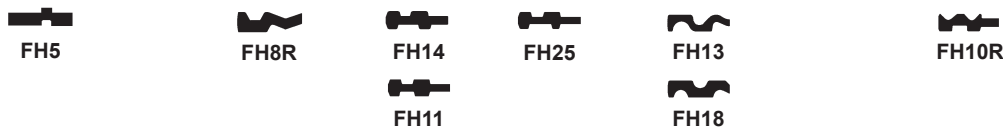
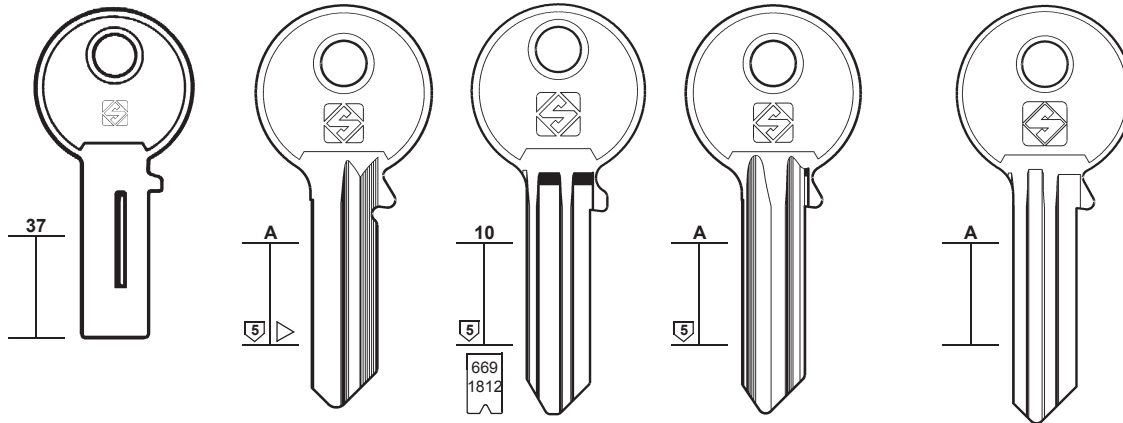

..... A  
 ..... A (NEW)  
 123456789

CITY - DIAMA - GISS - GPR  
 HUNIT - PICARDIE - SAMA

CF - CIB - IFAM - JL  
 NICO - PROBAT

PER:  
FOR:

### FTH

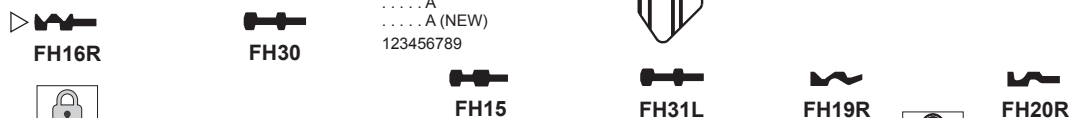
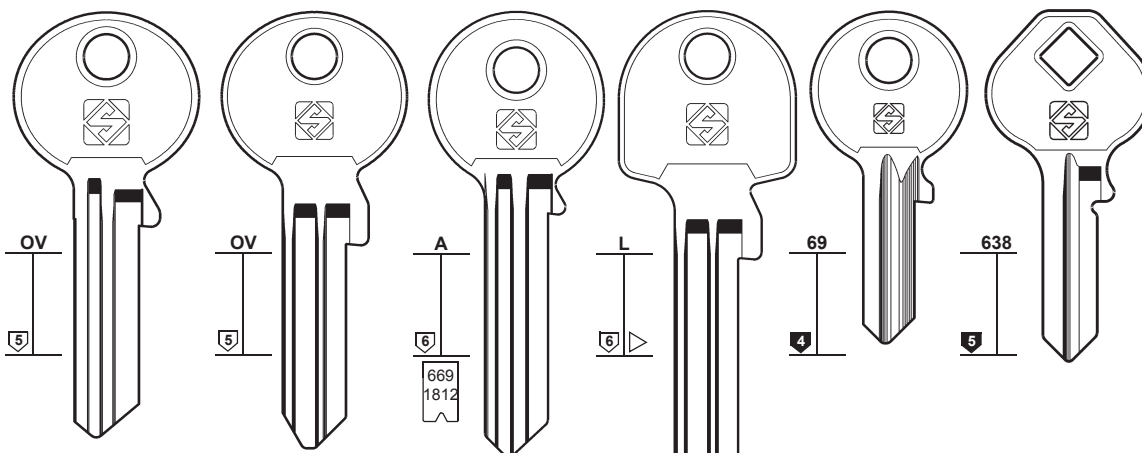

..... A  
 ..... A (NEW)  
 123456789



CIBC - CITY - SUF





92

PER / FOR

- FTH (FR)**  
 CODEM  
 FEDERAL  
 GOTTA  
 IFAM  
 ITO  
 KARO  
 SP  
 TOVER  
 YALTRES  
 + ABUS (8)  
 + BRUMME (40)  
 + CAS-CISMA (45)  
 + GLOBE (97)  
 + TITAN (183)

**FUARO (RU)**

- FUHR (DE)**  
 CES (47)  
 JOWIL (110)

- FULLEX (FR)**  
 GEGE (93)

PER:  
FOR:

FTH

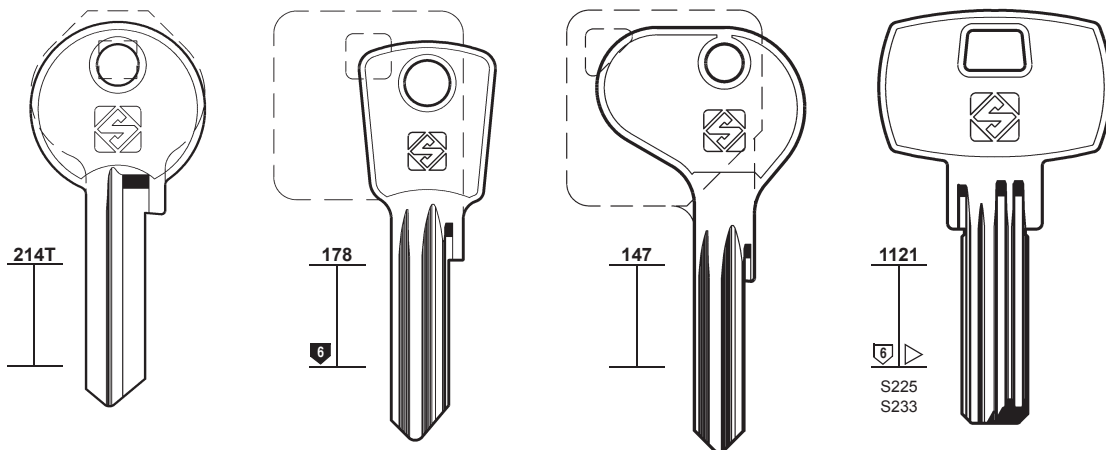

FH23R



FH21R



FH22R



FH24R



FH12



FEDERAL



FEDERAL



FEDERAL



CODEM - GOTTA - ITO  
TOVER - YALTRES

PER:  
FOR:

FTH

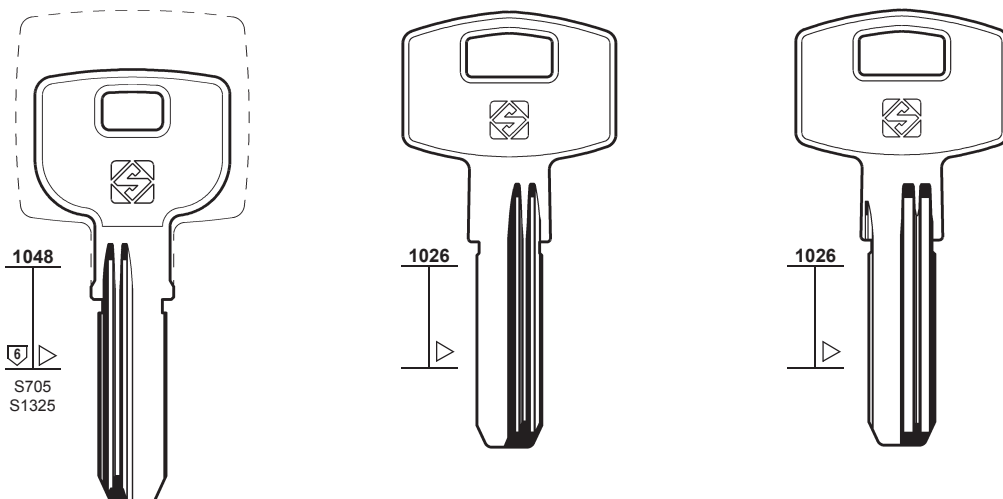

FH17R

.....1-2-3-4-5

IFAM  
KARO



FH37R



FH32



FH33



SP

PER:  
FOR:

FTH

FUARO

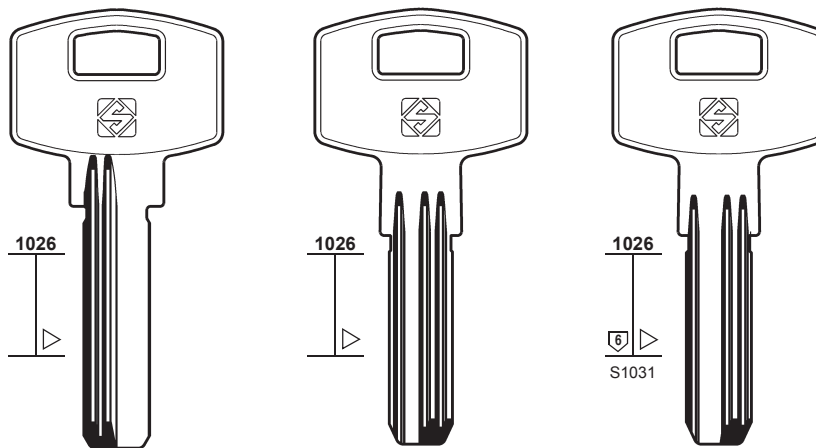

FH34R



FH35



FH36



FU1



SP



SP

PER:  
FOR:

### GABON

### GATEMATE

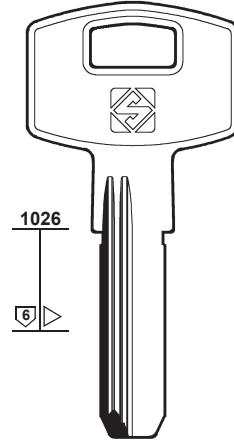
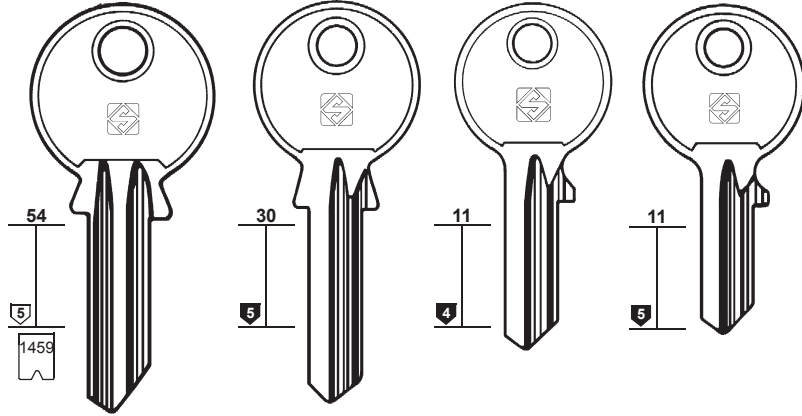

# 93

#### PER / FOR

#### GABON (FR)

CHG  
DESPREZ  
GALLUS  
JOLY  
MAXIGARD  
PICARDIE  
SOS  
SUREX  
WINNER

#### GAINSBOROUGH (AU)

LOCKWOOD (127)  
TESA (181)

#### GALLUS (FR)

GABON (93)

#### GARI (ES)

AGA (11)

#### GARRISON (GB)

MUL.T.LOCK (144)

#### GATEMATE (GB)

#### GB (FR)

#### GBS (DE)

#### GEA (IT)

#### GEBA (DE)

+ BKS (34)

#### GEBRO (DE)

CORONA (63)

#### GEFI (DE)

CISA (55)

#### GEGE (AT)

ABUS  
FLIK  
FULLEX  
GLOSTAL  
GRUNDMANN  
HÖHRMANN  
PEROHAUS  
TZAFRER  
+ ABUS (7)

PER:  
FOR:

### GB

### GBS

### GEA

### GEBA

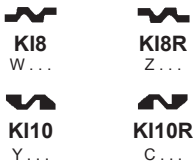
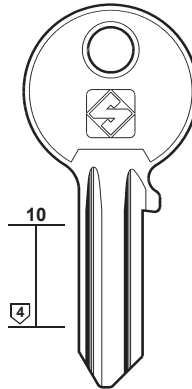
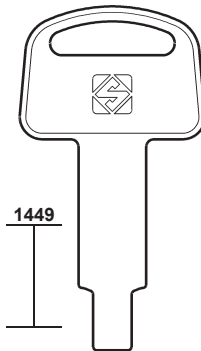
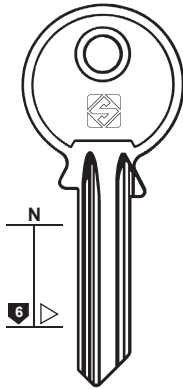
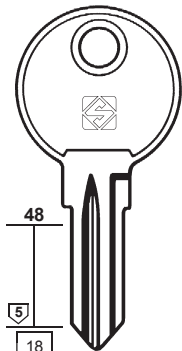

1-224



PER:  
FOR:

### GEGE

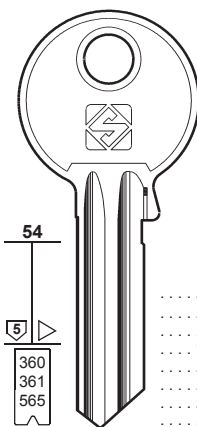
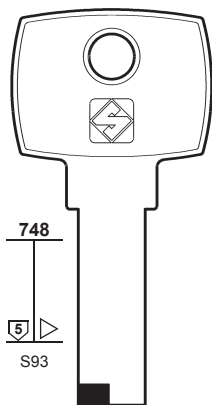

Z ...  
101-120



FULLEX  
GLOSTAL  
GRUNDMANN  
HÖHRMANN  
PEROHAUS

..... 000000-210079  
..... (.) 1234567890  
..... ( ) 1234567890  
..... 1234567890ABCDEF  
..... 1234567890ABCDEF  
..... (.) 1234567890ABCDEF  
..... 5000001-5067680  
..... 500001-545303



ABUS - FLIK - TZAFRER



94

PER / FOR

GEGE (AT)  
LABOFA  
PEROHAUS  
+ ABUS (7)

GEM (US)  
CHICAGO (52)

GENTILI (IT)  
CILA (53)

PER:  
FOR:

GEGE

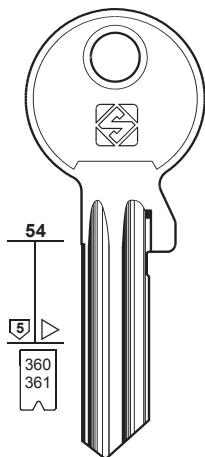

..... 5000001-545303  
..... (.)  
1-2-3-4-5-6-7-8-9-0

- GE182X
- GE119X
- GE52X
- GE34X

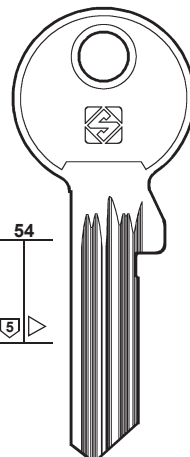

- GE178RX-7 GE178RX-8
- GE178RX-6 GE178RX-11
- GE178RX-5 GE178RX-12
- GE178RX-4 GE178RX-13
- GE178RX-3 GE178RX-15
- GE178RX-2 GE178RX-16
- GE178RX-1 GE178RX-17

PER:  
FOR:

GEGE

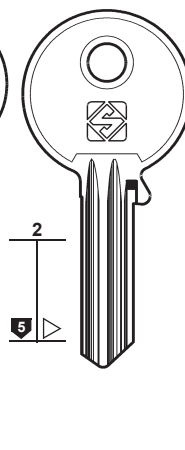
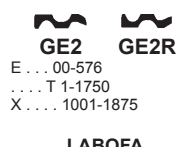
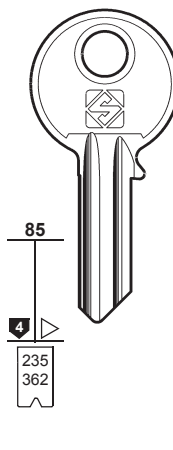
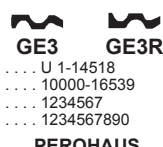
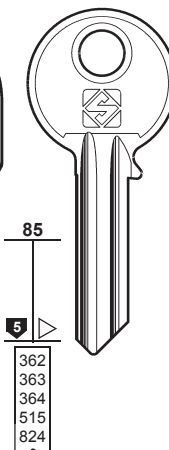
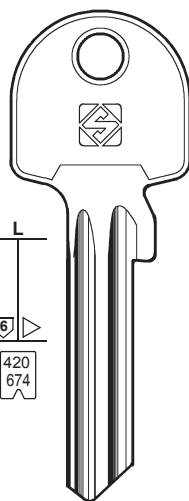
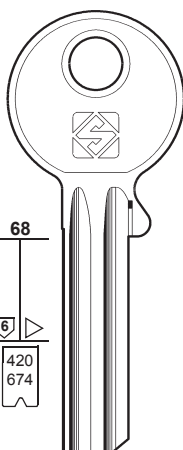
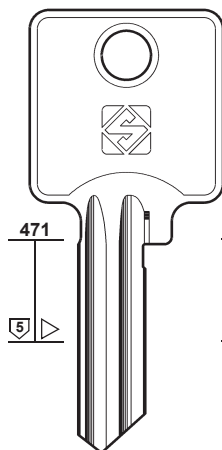

PER:  
FOR:

GEGE

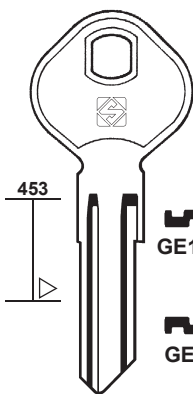

- GE15R
- GE15
- GE16 GE16R
- GE17 GE17R

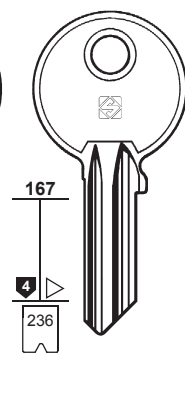
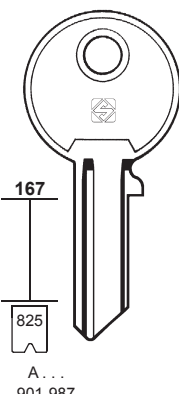

- GE18  
Z..... (5)  
1001-1245
- GE20  
M 7  
Z.....  
1491-1735
- GE22  
M 10  
Z.....  
1981-2222
- GE23  
Z..... (28)  
12591-13742
- GE24  
M 29  
Z.....  
13743-14894
- GE25  
M 30  
Z.....  
14895-16046
- GE19R  
M 6  
Z.....  
1246-1490
- GE21R  
M 9  
Z.....  
1736-1980
- GE23R  
Z..... (19)  
2223-3374
- GE24R  
M 20  
Z.....  
3375-4526
- GE25R  
M 21  
Z.....  
4527-5678
- GE26  
M 31  
Z.....  
16047-17198
- GE27  
M 32  
Z.....  
17199-18350
- GE28  
M 33  
Z.....  
18351-19502
- GE29  
M 34  
Z.....  
19503-20654
- GE30  
M 35  
Z.....  
20655-21806
- GE31  
M 36  
Z.....  
21807-22958
- GE26R  
M 22  
Z.....  
5679-6830
- GE27R  
M 23  
Z.....  
6831-7982
- GE28R  
M 24  
Z.....  
7983-9134
- GE29R  
M 25  
Z.....  
9135-10286
- GE30R  
M 26  
Z.....  
10287-11438
- GE31R  
M 27  
Z.....  
11439-12590



PER:  
FOR:

### GERA

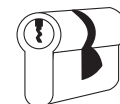

# 95

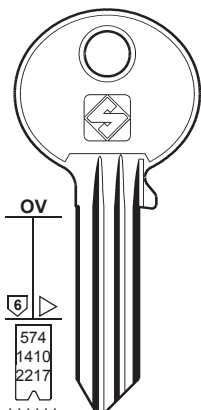

1-2-3-4-5-6-7-8-9  
..... 1-2-3-4-5-6-7  
N..... 1-28800

**GR1R**

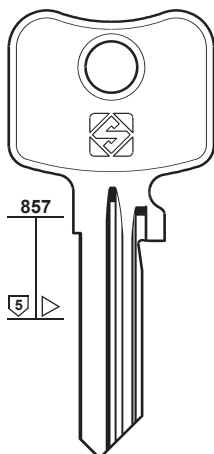

5

**GR2R**

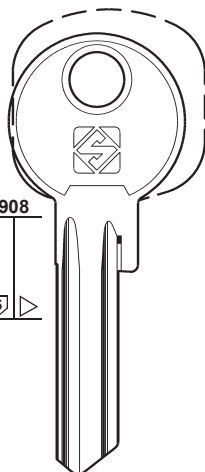

5

**GR3**  
PZ6900

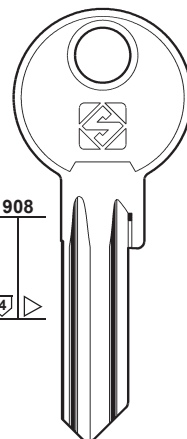

4

**GR4**  
PZ5900

PER / FOR

**GERA** (DE)

- + BUVA (44)
- + ISEO (108)
- + SATURN (165)
- + STARLET (176)

**GERDA** (PL)

- MCM (134)

**GETE** (DE)

- CISA (55)

**GEVY** (GR)

- BASSI  
MOTTURA  
STUV
- + CISA (55)
  - + DELCA (65)
  - + P.C.  
CORTELLEZZI (153)

**GEWIRU** (DE)

- DOM (69)

**GEWISS** (IT)

**GHE** (DE)

- EMKA (77)
- LA PORTE (121)

**GHIDINI** (IT)

- ZANETTI A. (220)

**GIESCHE** (GB)

- CES (47)
- KFV (116)

**GIMM** (FR)

- RONIS (161)

**GIOBERT** (IT)

PER:  
FOR:

### GERA

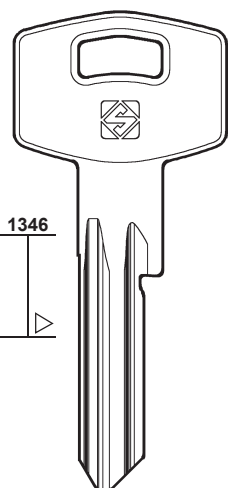

**GR15**

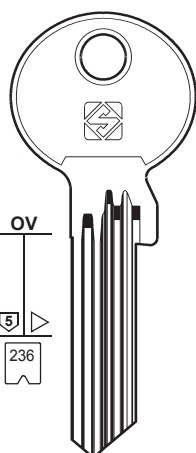

**GR9R-1**

**GR9-9**

**GR9-8**

**GR9-7**

**GR9-5**

**GR9R-4**

**GR9R-3**

**GR9R-6**

**GR9R-5**

**GR9R-2**

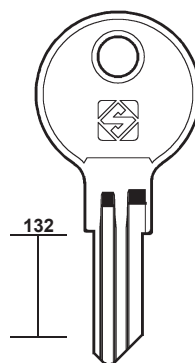

**GR16**

PER:  
FOR:

### GEVY

### GEWISS

### GIOBERT

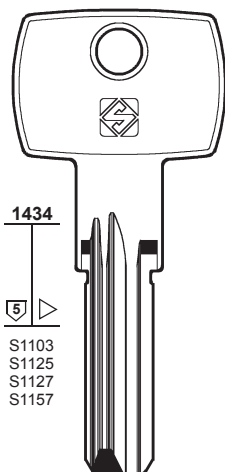

**GVV1R**

..... 600001-613040  
..... 900001-902780

BASSI - MOTTURA - STUV

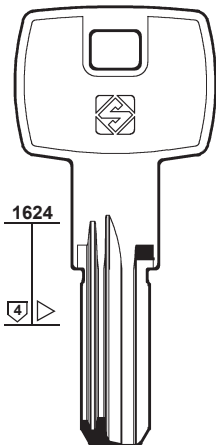

**GVV2R**

BASSI

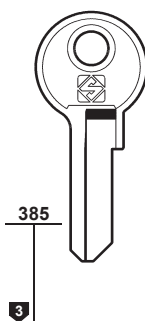

**GWS1**

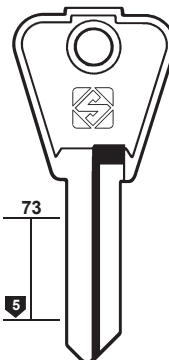

**GT4**

**GT4R**

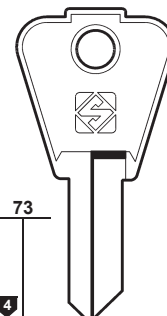

**CM2**

**CM2R**





96

PER / FOR

GIOBERT (IT)  
OLIVETTI

GIBBONS (GB)  
WILLENHALL

GIP (FR)

GISS (FR)  
FTH (91)

GIUSSANI (IT)

BANKA  
BRETER  
CAB  
ELSA  
ELVOX  
FBC  
LUME  
METALCASTELLI  
MLP  
OAL  
PASTORE  
PLG  
SIMECA  
+ BRETER (38)  
+ TITAN (183)

PER: FOR:	GIOBERT	GIBBONS	GIP	GIUSSANI
	 21 308	 168	 46	 1384
	GT1 GT3R OLIVETTI	GT3 E GT3R F WILLENHALL	GN1 GP1	GS17

PER: FOR:	GIUSSANI				
	 22 207	 558 1590	 2 5	 2 4	 2 3
	GS1 GS4R E...9001-9741 SM1R GS9	GS1R GS4 E...3001-3480 SM1 9001-9741 G... 3001-3480 3001-3480 9001-9741 0-480	GS13 ... 1-2-3-4	GS3 GS3R GS2 GS2R	GS10 GS10R
	CAB - ELSA - ELVOX PLG - SIMECA	OAL - LUME	BRETER	FBC - MLP	METALCASTELLI

PER: FOR:	GIUSSANI				
	 167	 463	 54 5	 182 5	 A 4
	GS12R MLP	GS11R BANKA	GS5 GS6	GS8	GS7 PASTORE

PER: **GLAZIEV**

PER: **GLOBAL**

PER: **GLOBE**

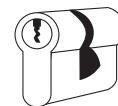

**97**

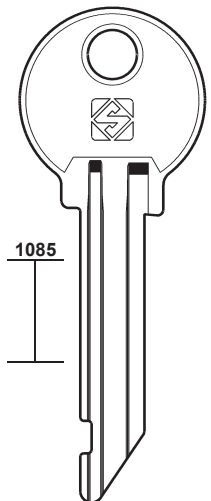

**GLZ1**

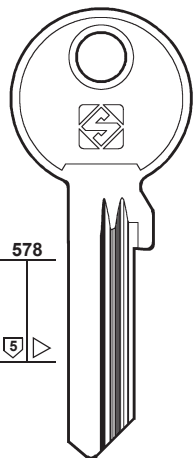

**GBL1R**

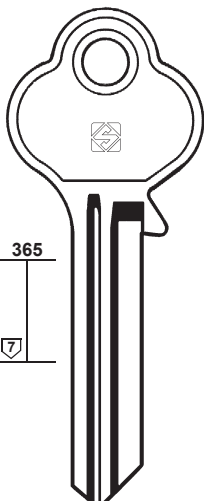

**GL8**

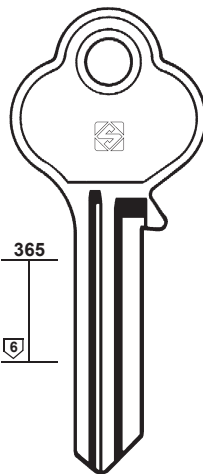

**GL7**



**GL7R**

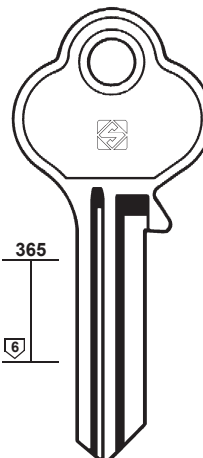

**GL6**



**GL6R**

PER / FOR

**GLAZIEV (RU)**

**GLOBAL (GB)**

**GLOBE (TW)**

ANLO

DOFIN

FTH

GOLD-DOOR

IFAM

LARK

LUCO

MIAN-FORCE

SOF

WHALE

+ GOLD DOOR (99)

+ HILLO (102)

PER:  
FOR:

**GLOBE**

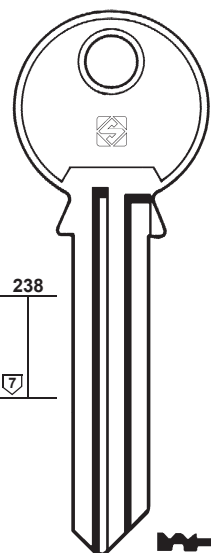

**GL11R**



**MIAN-FORCE**

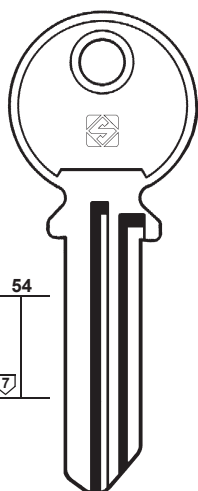

**GL12R**

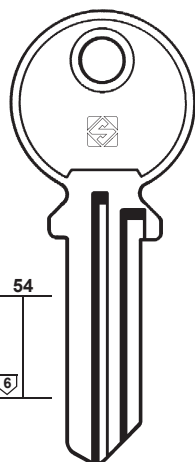

**GL13R**



**SOF**  
**GOLD-DOOR**

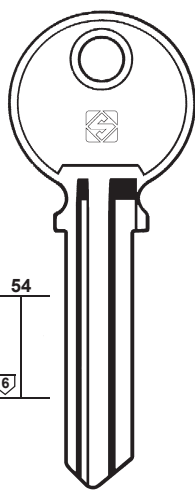

**GL9**



**GL9R**

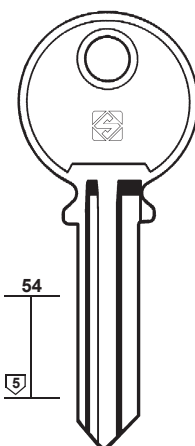

**GL10**



**GL10R**

**ANLO - LUCO**

PER:  
FOR:

**GLOBE**

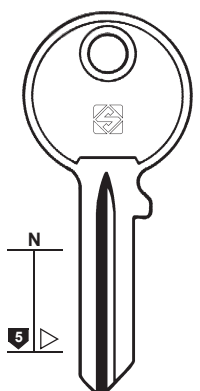

**GL4**

**GL4R**

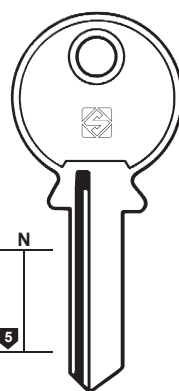

**GL3R**

**GL3**

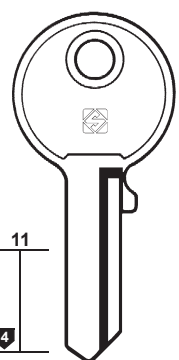

**GL5**

**GL5R**

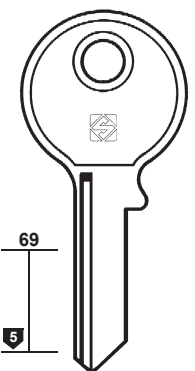

**GL17R**



**DOFIN - FTH**  
**GOLD DOOR**  
**SOF**

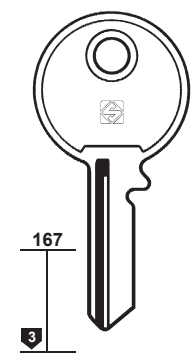

**GL2R**

**GL2**



**IFAM**



98

PER / FOR

GLOBE (TW)  
GOLD-DOOR  
+ \* HILLO (102)

GLOSTAL (DE)  
GEGE (93)

GOAL (JP)  
+ \* GSS (100)

GODREJ (IN)

GOLD (BR)

PER:  
FOR:

GLOBE

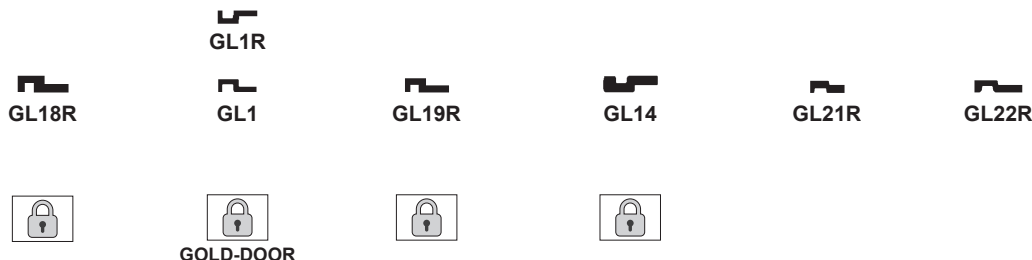
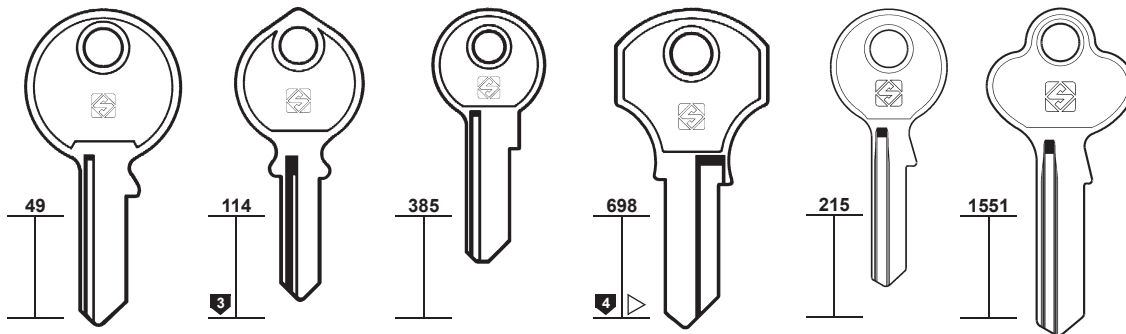

PER:  
FOR:

GOAL

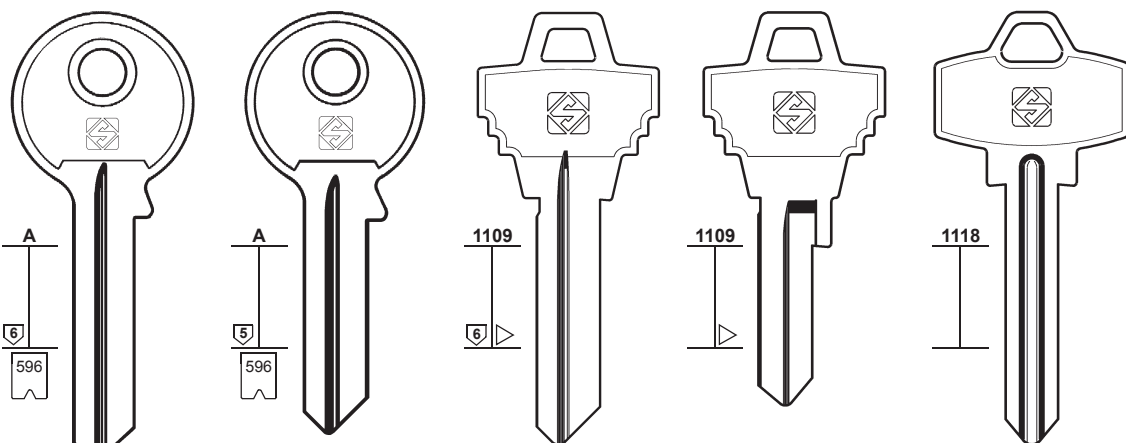

Y.....  
1-2-3-4-5-6-7



PER:  
FOR:

GOAL

GODREJ

GOLD

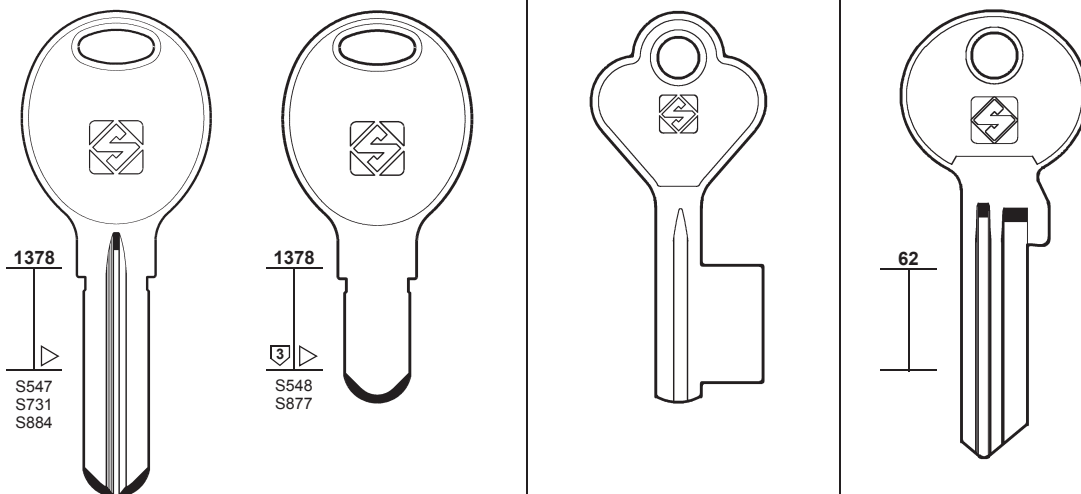

S547  
S731  
S884

S548  
S877



PER: **GOLD DOOR**      GP      G.R. (GUERVILLE RIQUIER)



**99**

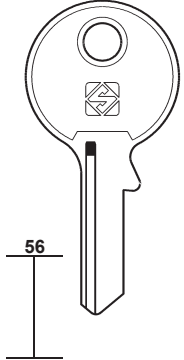

56



GL20

GLOBE

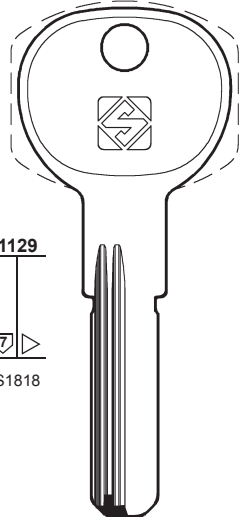

1129  
7  
S1818



GPI1

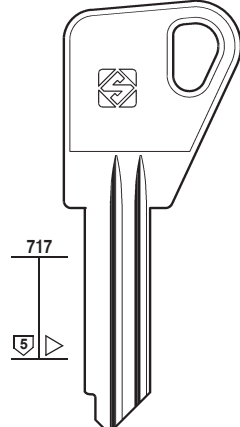

717  
5



RIQ10R

PER: **G.R. (GUERVILLE RIQUIER)**

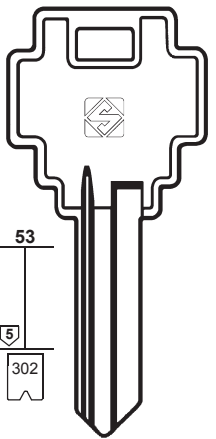

53  
5  
302



RIQ3

R ..... 1234567890



RIQ2

F ..... 1234567890  
G ..... 1234567890



RIQ6S

Y ..... 1234567890

MONDIAL

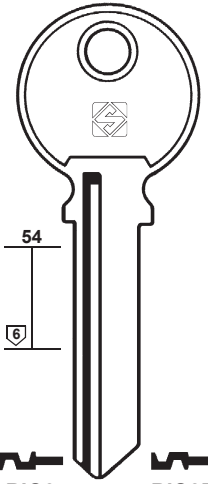

54  
6



RIQ8



RIQ8R



RIQ7



RIQ7R

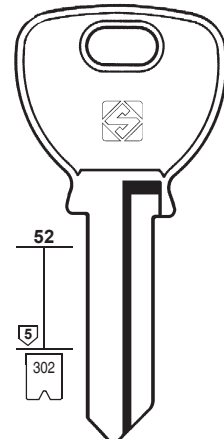

52  
5  
302



RIQ1

Z ..... 1234567890



RIQ1R

T ..... 1234567890  
XT ..... 1234567890  
Y ..... 1234567890

DEBEAURAIN - SE

PER: **G.R. (GUERVILLE RIQUIER)**

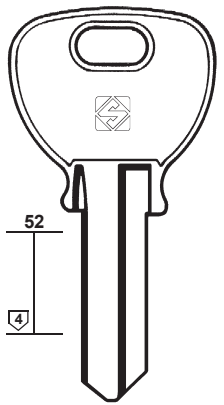

52  
4



RIQ5



RIQ5R

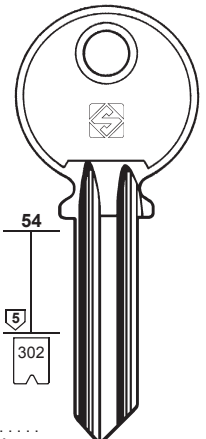

54  
5  
302



RIQ4



RIQ4R

.....  
A .....  
1-2-3-4-5-6-7-8-9-0

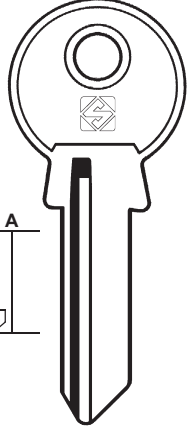

A  
5



RIQ9



RIQ9R

BRICARD - PERRIER

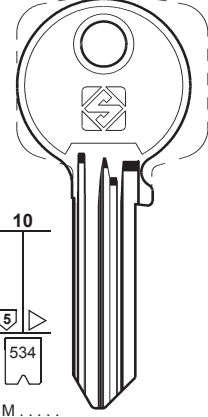

10  
5  
534



RIQ11



RIQ11R

M .....  
P .....  
S .....  
1-2-3-4-5-6-7-8-9-A-B-C-D-E-H-K-L

ABUS - BRICARD

PER / FOR

**GOLD-DOOR (TW)**  
GLOBE  
+ GLOBE (97-98)

**GOLLOT (FR)**  
RONIS (161)

**GOTTA (DE)**  
FTH (92)

**GÖTZ (DE)**  
KFV (116)

**GP (IT)**

**GPR (FR)**  
FTH (91)

**G.R. (FR)**  
**(GUERVILLE-RIQUIER)**  
ABUS  
BRICARD  
DEBEAURAIN  
MONDIAL  
PERRIER  
SE

**GRAF (DE)**  
KFV (116)

**GRAYHILL (US)**  
ILLINOIS (106)



# 100

PER / FOR

**GRIFO** (TW)

**GRUNDMANN** (AT)

👁️ **GEGE** (93)

**GS** (GR)

👁️ **STAR** (175)

**GSA** (IT)

👁️ **CAS-CISMA** (45)

**GSS** (JP)

**GOAL**

**GTV** (DE)

**JOWIL**

**TIEFENTHAL**

+ 👁️ **CISA** (55)

+ 👁️ **EMR** (77)

+ 👁️ **JOWIL** (110)

**GUARD** (HK) (CZ)

**ABUS**

**EKLA**

**ROYAL**

+ 👁️ **ABUS** (8)

+ 👁️ **FAB** (82)

**GUARDIAN** (I)

👁️ **CAS-CISMA** (45)

👁️ **F.F.** (87)

PER: FOR:	GRIFO	GSS	GTV	
			 GV1    GV2    GV3  GV4R    GV5R    GV6R	
		<b>GOAL</b>	<b>TIEFENTHAL</b>	<b>JOWIL - TIEFENTHAL</b>

PER:  
FOR:

### GUARD

<b>GD10</b>	<b>GD10R</b>	<b>GD8</b>	<b>GD5</b>	<b>GD2</b>	<b>GD4</b>
14T1 ..... 00000-99999	13T1 ..... 00000-99999				
14T ..... 00001-80000	13T ..... 00001-80000	<b>GD8R</b>		<b>ABUS - EKLA - ROYAL</b>	
14T ..... 80001-99999	13T ..... 80001-99999				
	13T2 ..... 00000-99999				

PER:  
FOR:

### GUARD

<b>GD6R</b>	<b>GD3</b>	<b>GD7R</b>	<b>AB23</b>	<b>GD1</b>
			 AB23R ... 1-24 ... 65/251-2-3-4-5	
			<b>ABUS</b>	<b>ABUS</b>
				mm 25

PER: FOR:	GUARUP	GUSHENG	HÄFELE		
	GUR1	GUS1	HF1R	HF73R	HF74 HF74R
					O.M.R.



# 101

PER / FOR
<b>GUARUP</b> (BR)
<b>GUSHENG</b> (DE)
<b>GUIDOTTI</b> (FR) +  RONIS (161)
<b>GUITTEL</b> (FR) +  ABUS (8)
<b>GÜTLER</b> (DE) +  SIMECA (170)
<b>HÄFELE</b> (DE) O.M.R. +  BKS (34) +  CES (47-48) +  DOM (68-70) +  HUWIL (104) +  KIFERM (117) +  LAS (121)
<b>HABO</b> (DK) +  ASSA (25)
<b>HAGA</b> (BR)
<b>HAIDE</b> (TW) +  YETI (218-219)
<b>HALLE</b> (DE) +  BAB (29)
<b>HAMPTON</b> (GB) +  MASTER (131)
<b>HANNO</b> (DE) +  CES (47)
<b>HARLOC</b> (US) +  EAGLE (75)
<b>HARP</b> (HK)
<b>HASLER</b> (DE) +  SEA (166)
<b>HASMAN</b> (IN)
<b>HB</b> (IT) +  LEGALLAIS (122)
<b>HBC</b> (DE) +  MELSMETALL (135)
<b>HDL-PACRI</b> (BR)

PER: FOR:	HÄFELE	HAGA			
	HF75 HF75R ..... 1-3936	HAG1 HAG1R	HAG6R	HAG7 HAG7R	HAG5
		..... 1-2-3-4-5-6			

PER: FOR:	HARP	HASLER	HASMAN	HDL-PACRI
	HP1R	HS1R	HA1R	HDL3 HDL3R



# 102

**PER / FOR****HDL-PACRI (BR)****HEAD (TW)**

YETI (218-219)

**HECTOR (ES)****HEGO (DE)**

CORBIN (60)

**HEKNA (DE)**METALCASTELLI  
RAUCO  
REGENT

+ YETI (68-69)

+ YETI (103)

**HEL (ES)****HEMA (TW)**

VACHETTE (199)

**HEMY (FR)**

YETI (218-219)

**HENDERSON (GB)**

REGENT

+ YETI (193)

**HERMES (TW)**

YETI (218-219)

**HERO (DE)**

HILLO (102)

HR (103)

**HESTE (DE)**

CORBIN (60)

**HILLO (TW)**

GLOBE

HERO

**HK (DE)****HMP (TW)**

ALPHA (16)

**HOBBY (GB)**

EURO LOCKS (80)

**HÖHRMANN (DE)**

BKS (34)

CES (47)

DOM (70)

GEGE (93)

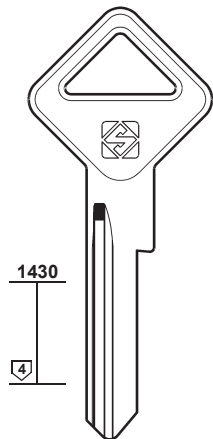
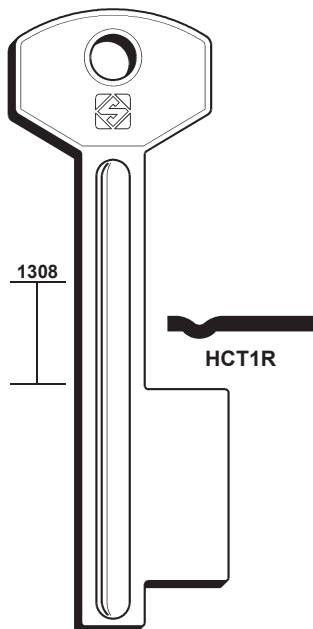
**HOK (TR)****PER: HDL-PACRI**1430  
4**HDL1R****HECTOR**

1308

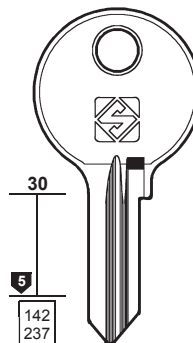
**HCT1R****HEKNA**30  
5  
142  
237**HN1**

... 1001-1425

**HN4****HN2**

C... 1251-1700

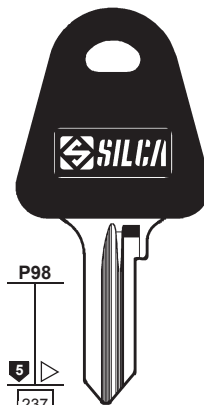
**HN5R**P98  
5  
237**HN1P**

... 1001-1425

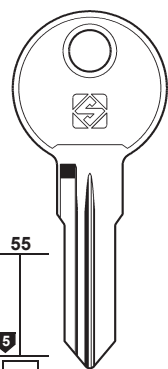
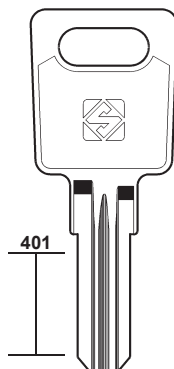
**METALCASTELLI  
RAUCO - REGENT****PER:  
FOR:****HEKNA**55  
5  
755

401

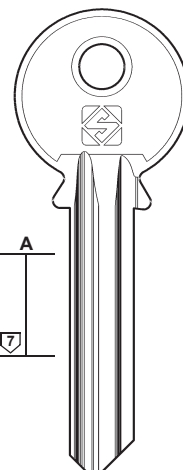
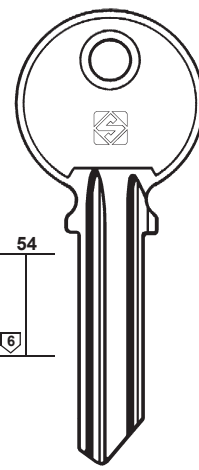
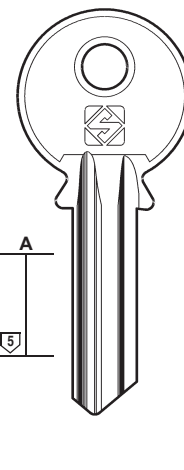
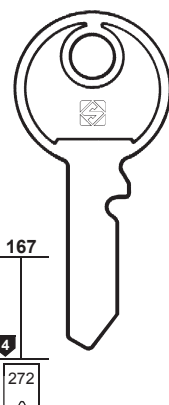
**HN6****HN3**... 1-2-3-4  
... 1501-1540**HN3R****HN7****HEL**A  
7**HE3**54  
6**HE3R****HE2****HE2R**A  
5**HE1****HE1R****PER:  
FOR:****HENDERSON**167  
4  
272**HEN1**

R... 008-254

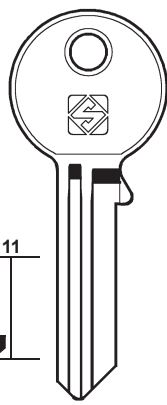
**REGENT****HILLO**11  
5**HL1R**

mm 40

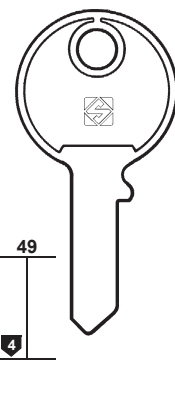
**GLOBE - HERO****HK**49  
4**H1****H1R**

mm 20

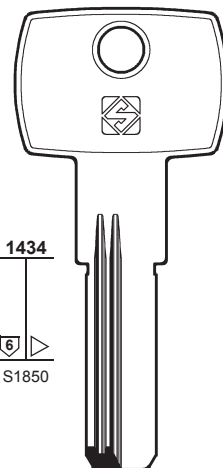
**HOK**1434  
6  
S1850**HOK1R****HOK2R**



PER: FOR:	HOPPE	HORSE	HR	HTEC
	1261 5 1643	438 5	521 5	132 1809 E... 1-698
	HPP1 HPP1R ..... 1001-3187	HO1R HO2R	HR1 E	HTE1
	 BURG - KIND MAUSER - TOKOZ		 HEKNA - HERO - OJMAR	



# 103

**PER / FOR**

**HOPPE (DE)**  
BURG  
KIND  
MAUSER  
TOKOZ  
+ BURG (43)

**HOOPLY (CN)**  
 CINA (54)  
 WANJIN (207)

PER: FOR:	HTV	HUDSON
	54 5	132 5 142
	OV 5	11 5 1037
	HT1 HT1R 07	HD8R HD1R HD1 A... 201-1050 C... 500-699 H... 601-1100 HM... 201-1050
	HT2 04	HD2 HD2R ... 01-175
	VAUGHN SHAW - VAUGHN - YALE	 HUDSON

**HORSE (TW)**

**HR (DE)**  
HEKNA  
HERO  
OJMAR

**H.R.S. (FR)**  
 TH (182)

**HSA (DE)**  
 KJV (116)

**HTEC (ES)**

**HTV (GB)**  
SHAW  
VAUGHN  
YALE

**HUDSON (US)**  
+ FORT (90)  
+ SEGAL (167)  
+ YALE (213)

**HUGIN (SE)**

PER: FOR:	HUGIN					
	178 5	178 5	616 5	616 5	616 5	616 5
	HG1 A	HG2 A	HG3 P	HG4 R	HG5 X	HG6 Z



# 104

### PER / FOR

**HUGO** (DE)  
+ BRISANT (40)

**HUNIT** (IT)  
+ FTH (91)

**HUTRA** (DE)  
 SCHLECHTENDAHL (166)

**HUWIL** (DE)  
CEKA  
CHRIST  
HÄFELE  
L.M.C.  
MAUSER  
SCHÄRF  
STEELCASE  
STRAFOR  
WILLACH  
WÜRTH  
+ BOMORO (37)  
+ DOM (68)  
+ EURO LOCKS (78)

**IALEX** (PT)

**IBFM** (IT)  
+ EURO LOCKS (79)  
+ L & F (128)

PER: FOR:	HUGO	HUNIT	HUWIL
	 1219  54 5 3763	 L 5	 1170 6 S1183  1674
	 <b>HGO1R</b> 	 <b>HUT1</b>	 <b>HW15R</b> <b>HW21R</b> CEKA - HÄFELE MAUSER - SCHÄRF

PER: FOR:	HUWIL			
	 30 5 238 501 2500	 P77 5 238 501 2500	 48	 401 6 539 1437
	 <b>HW1</b> ... 2001-2207 ... N 2001-2204 ... N 2001-2207 ... N 5-1878 ... SO 8101-8300 ... LM 7946-8149	 <b>HW1P</b>	 <b>HW2</b> R <b>HW3</b> V	 <b>HW4R</b> ... 000-051 ... 0001-1915 ... 0A-9Z IG. ... 14101-16020 ... 22001-23920 DE. ... 25500-27419 ... A 3001-4000 W. ... 3001-4000 ... 3001-4001 ... 3010-3999 ... 3202-4004 ... A 5001-5050 A. ... 5001-5050 ... 5001-6169 ... 7000-8001 PL. ... 7420-8419 RA. ... 7480-8479 ... 7526-7726 FH. ... 7526-7726 ... 8001-8321 ... 8001-9541 ... LH 8701-9700 UO. ... 9000-9999
	CHRIST - HÄFELE - L.M.C. WILLACH - WÜRTH		HÄFELE STRAFOR - STEELCASE	

PER: FOR:	IALEX	IBFM		
	 54 6	 22	 1549 5 6 S1521 S1933 S1934	 1434 5 S1976
	 <b>IX1</b> <b>IX1R</b>	 <b>IBF1</b> <b>IBF1R</b>	 <b>IBF2R</b>	 <b>IBF3R</b>

PER: FOR:	IBM	ICA	ICSA		
	IBM1	ICA1R	ICS1	ICS1R	ICS2
					ICS3
					ICS3R
					ICS5
			ORLANDO REMO - ZANI		



# 105

PER / FOR

ICA (ES)

ICSA (IT)  
ORLANDO  
REMO  
ZANI  
+ LINCE (123)

IDEAL (TW)  
 DOM (68)

IDEAL SECURITY (US)  
 WEISER (208)

IDRO STOP (IT)  
CEV

IES (IT)

IFAM (ES)  
JOMA  
RIPA  
+ BUGA (40)  
+ CHICAGO (52)  
+ CISA (57-58)  
+ FTH (91-92)  
+ GLOBE (97)  
+ ISEO (108)

PER: FOR:	IDRO-STOP	IES	IFAM		
	ISP2 ... 1-78	ISP4 ... 1-78	IES1R	IF1	IF7
					IF7R
	CEV				

PER: FOR:	IFAM			
	IF3	IF3R	IF2	IF2R
			IF6 ... 4001-4240	IF8
	IF8R			
	mm 45-50-55	mm 35-40	RIPA	JOMA
				JOMA



# 106

### PER / FOR

#### IFAM (ES)

- BATU
- JOMA
- RIPA
- TEM
- + BUGA (40)
- + CHICAGO (52)
- + CISA (57-58)
- + FTH (91-92)
- + GLOBE (97)
- + ISEO (108)

#### IGS (FR)

#### IJ (FR)

- JTF
- + JTF (111)
- + MERONI (137)
- + STAR (176)

#### IJN (FR)

- + KIFERM (117)

#### ILARGI (ES)

#### ILCO (US)

BARGMAN

#### ILLINOIS (US)

- GRAYHILL
- LAGRANGE
- OTIS
- SEEBURG
- + CHICAGO (51)

PER:  
FOR:

## IFAM

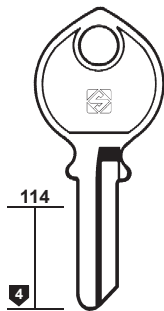

IF4



IF4R



mm 25

BATU - RIPA - TEM

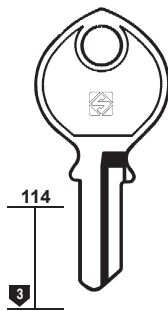

IF5



IF5R



mm 20

JOMA - TEM

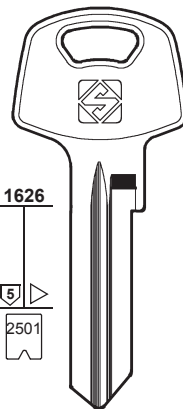

IF12R

..... (D) 0123456  
(D) ..... 55002-58124

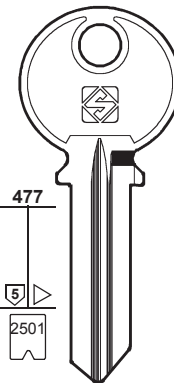

IF13R

..... (D) 0123456  
(D) ..... 55002-58124

PER:  
FOR:

## IFAM

## IGS

## IJ

## ILARGI

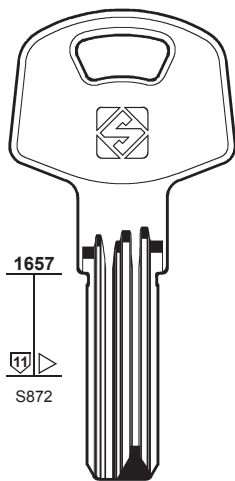

IF14

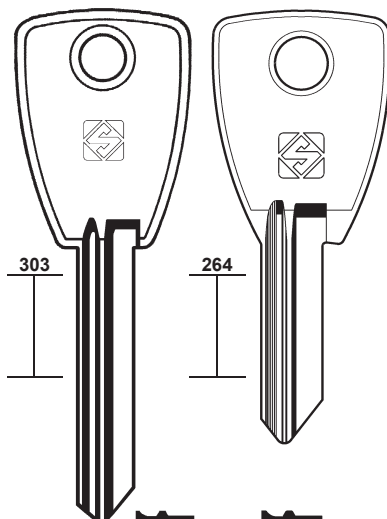

IS2



IS1

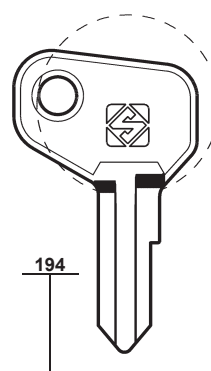

IJ1



JTF

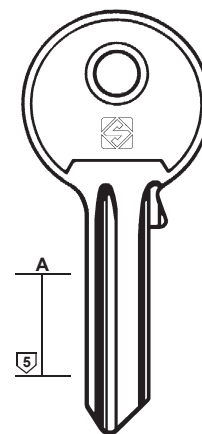

IL1R



IL1

PER:  
FOR:

## ILCO

## ILLINOIS

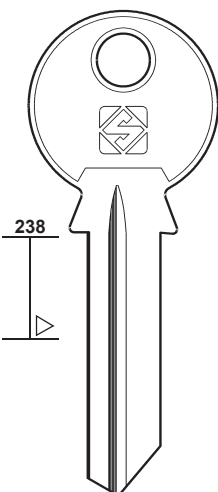

ILC13R

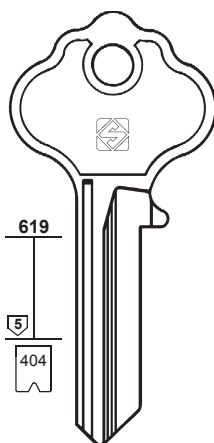

ILC2

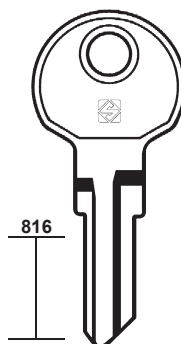

ILC6

BARGMAN

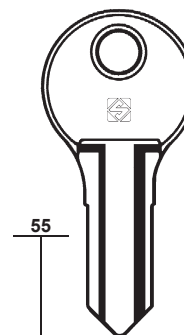

IN1



NUOVO PIGNONE

GRAYHILL - LAGRANGE  
OTIS - SEEBURG

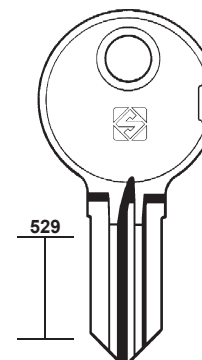

IN2

H



IN3

J



PER:  
FOR: **ILLINOIS**

**ILS**

**IMAB**



**107**

PER / FOR

**ILLINOIS** (US)  
+ CHICAGO (51)

**ILS** (IT)  
+ FASEM (86)

**IMAB** (BR)

**IMBAC** (FR)  
+ PREFER (158)

**IMP** (DE)  
+ ABUS (8)

**IMSI** (IT)  
+ PERINO (154)

**INDAUX** (ES)  
+ FAC (84)

**INDESIT** (IT)  
ELSI  
MIT  
RECA

**INGERSOLL** (GB)

**INLOC** (FR)  
+ BRICARD (39)

**INSA** (IT)

**INT** (IT)

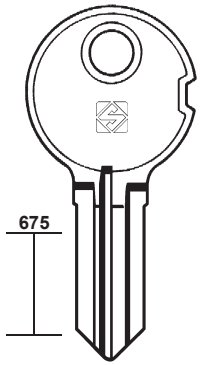

**IN5**



**DUO**

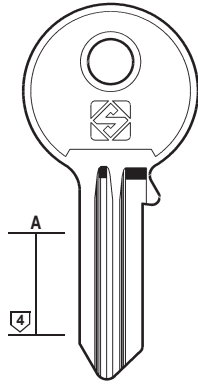

**ILS1**

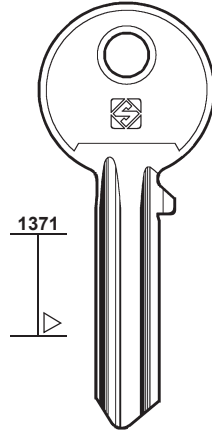

**IAB7**

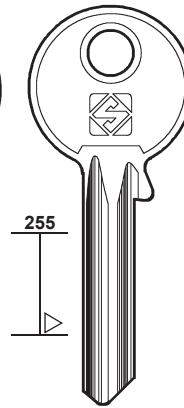

**IAB8**

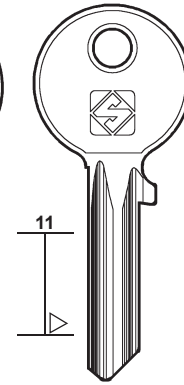

**IAB9**

PER:  
FOR: **INDESIT**

**INGERSOLL**

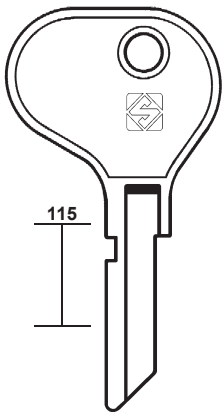

**ID1**  
REG

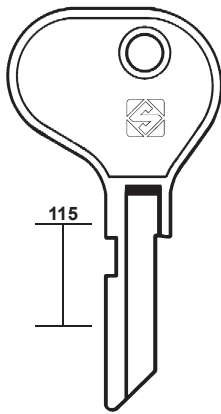

**ID2**  
X

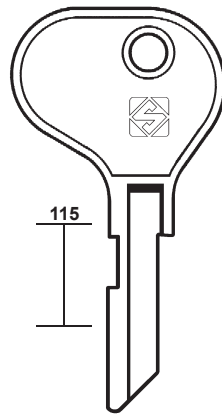

**ID3**  
MGR



ELSI - MIT - RECA

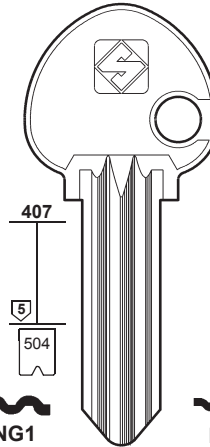

**ING1**  
A . . . . . 1-2-3-4

**ING2**  
W

**ING5**  
S . . . . . 1-2-3-4

**ING6**  
N



PER:  
FOR: **INGERSOLL**

**INSA**

**INT**

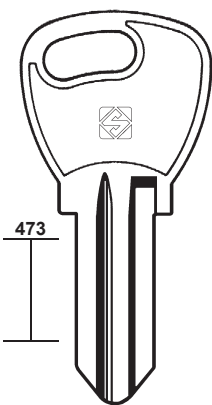

**ING3**

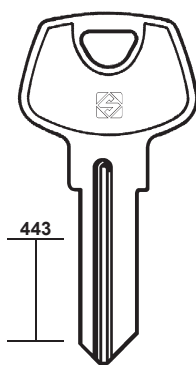

**ING4R**

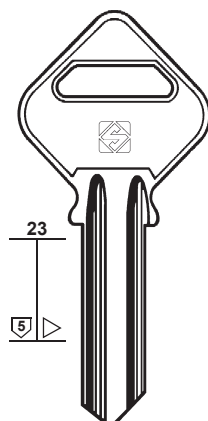

**INS1**

**INS1R**

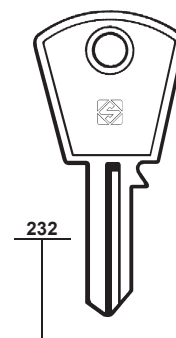

**IT1**

**IT1R**





# 108

### PER / FOR

**INT** (IT)

**I.R.** (FR)

+ DOM (71)  
+ W.M.S. (211)

**ISABEL  
FAINER'S** (P)

**ISEO** (IT)

CAM  
CITY  
GERA  
IFAM  
STAR  
VACHETTE  
+ UCEM (192)  
+ VACHETTE (198)

PER: FOR:	INT	I.R.	ISABEL FAINER'S	ISEO
	 232	 1434	 A 5	 10 5 330 2567
	 IT2 IT2R	 IR1	 IB1	F3 IE31  F3 IE27R ..... 0-1-2-3-4-5-6-7-8-9   IE13   IE12   IE10
				 IE6 GERA - IFAM - STAR ..... 012345678 KFC ..... 1-28800 LCE ..... 1-17513 Y ..... 1-2000 Y0 ..... 1-2000   IE6R ..... 012345678 KFC ..... 1-28800 ..... 1-6516   IE2 ..... 1-2000 ..... 0-1-2-3-4-5-6-7-8   IE2R ..... 0-1-2-3-4-5-6-7-8   IE9 ..... 1-2000 ME ..... 1-210 CAM

PER: FOR:	ISEO				
	 10 4 330	 A 3 330	 N 5 329 3162	 11 4 329	 74 3 329
	..... 0-1-2-3-4-5-6-7-8	... 0-1-2-3-4-5-6-7-8	 IE28R F3	..... 1-2-3-4-5	... 1-2-3-4-5
	 IE7 IE7R	 IE8 IE8R	 IE3 IE3R ..... 1-2-3-4-5-6	 IE4 IE4R	 IE5 IE5R
	 IE224 IE225		 IE1 IE1R ..... 1-2-3-4-5-6		

PER: FOR:	ISEO			
	 OV 5 330	 1047 6 2668	 1129 5+6+6	 1130 5+6+6
	 IE6X LCE ..... 1-17513 Y ..... 1-2000 Y0 ..... 1-2000 ..... 012345678	 IE29 F6 A/Z A/Z A/Z ..... 1-48568	S99   S1191 S725   S1237 S726   S1238 S916   S1239 S965   S1240 S1108   S1241   IE14 R11	S100 S723 S963 S964   IE15 R6  ABL ..... 1-015328 ACY ..... 1-015328 AGL ..... 1-015328 ABF ..... 1-015694
			EDL ..... CFA ..... 1-27065 EDL ..... 1-350589 ECA ..... 1-050000 ECA ..... 100001-150000 EDA ..... 1-350589 EDY ..... 1-350612 EGE ..... 1-027508 EGE ..... 100001-127508 EGE ..... 200001-227508	CITY - VACHETTE 

PER:  
FOR:

# ISEO



# 109

PER / FOR

**ISEO (IT)**  
 ATRA  
 CITY  
 + UCEM (192)  
 + VACHETTE (198)

**ISSERSTEDT (DE)**  
 CORBIN (60)

**ITALBLOCK (IT)**  
 EUREKA (78)

**ITO (TR)**  
 CISA (55)  
 FTH (92)

**ITOKI (JP)**

**IULIA MAS FED (IT)**  
 FASEM (86)

**IWATA (JP)**

**JÄBA (DK)**

**JAPAN (JP)**

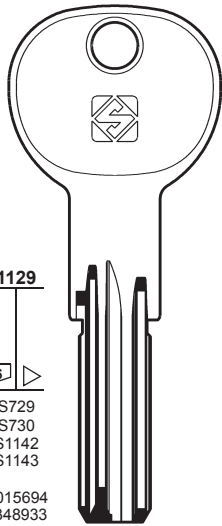

1129

5+6+6

S729  
S730  
S1142  
S1143

AAC ..... 1-015694  
 DAA ..... 1-348933  
 AMB ..... 1-012540  
 AMB ..... 100001-112540



IE26



ATRA - CITY

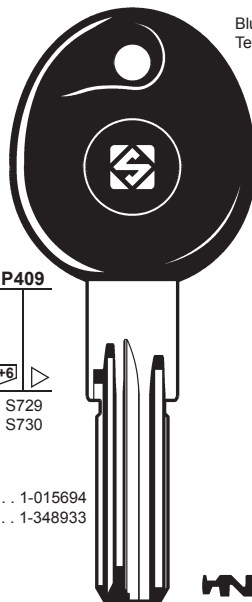

P409

5+6+6

S729  
S730

AAC ..... 1-015694  
 DAA ..... 1-348933



IE26P

Blue head  
Testa blu

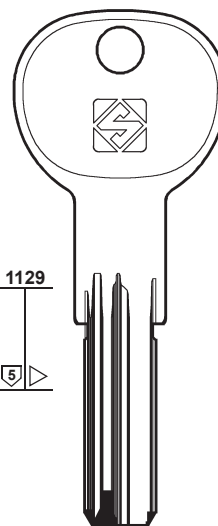

1129

5



IE30



PER:  
FOR:

# ITO

# ITOKI

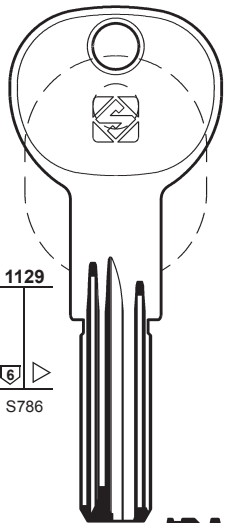

1129

6

S786



IO1

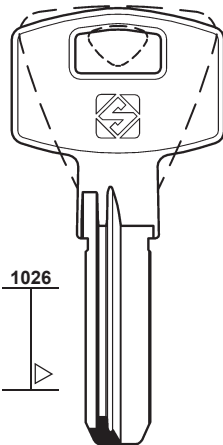

1026



IO2R

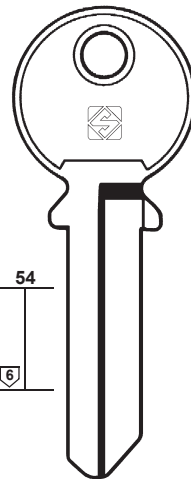

54

6



ITO1R



ITO2

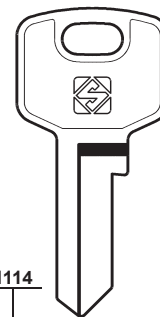

1114



ITO3



ITO3R

PER:  
FOR:

# IWATA

# JÄBA

# JAPAN

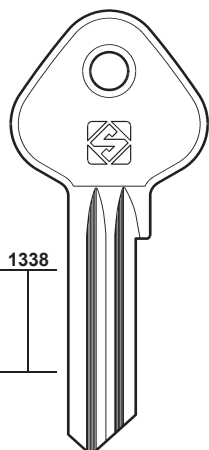

1338



IW1R

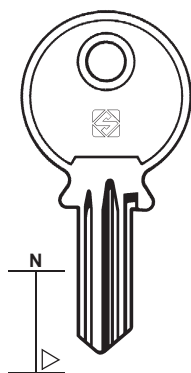

N



JB1

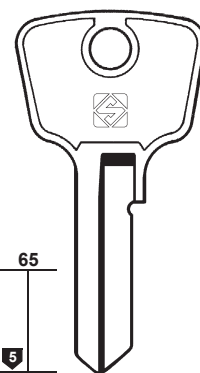

65

5



JPN1



JPN2

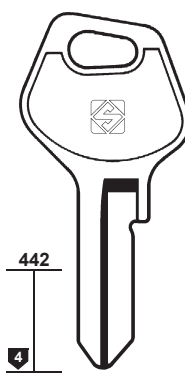

442

4



JPN3R





# 110

**PER / FOR**

**JARDI (ES)**

**JD (JP)**  
EYE ALPHA (16)

**JEHU (TW)**

**JET (DE)**  
EYE ABUS (7)

**JIP (FR)**  
EYE PREFER (157)  
EYE RONIS (161)

**JIS (ES)**  
SEMEL

**JL (FR)**  
EYE FTH (91)

**JMR (ES)**  
EYE EZCURRA (82)

**JNF (IL)**  
EYE EVERGOOD (80)

**JOLY (FR)**  
EYE GABON (93)

**JOMA (ES)**  
EYE IFAM (105-106)

**JOE (DE)**  
EYE WILKA (210)

**JOSTA (DE)**  
EYE CES (47)

**JOWIL (DE)**  
ESZ  
FUHR  
GTV  
JÜNGST  
MERCUR  
OSKO  
PANTHER  
TIEFENTHAL  
TRITON  
VOKO  
WEPA  
+ EYE EMR (77)  
+ EYE GTV (100)

PER: FOR:	JARDI	JEHU	JIS
	JAR1 JAR1R	JH1	JS1 JS1R
	JAR2 JAR2R		

PER: FOR:	JIS			
	JS2 JS2R	JS4 JS4R	JS3 JS3R	JS5P
	0-1-2-3-4-5-6-7-8-9			

PER: FOR:	JOWIL			
	JOW8	JOW1 JOW1R	JOW2 JOW5 JOW6 JOW7 JOW9 JOW10 JOW11	JOW12X JOW12RX
	ESZ - FUHR - GTV JÜNGST - MERCUR OSKO - PANTHER TIEFENTHAL TRITON - VOKO - WEPA			



PER:  
FOR:

**JOWIL**

**JPM**

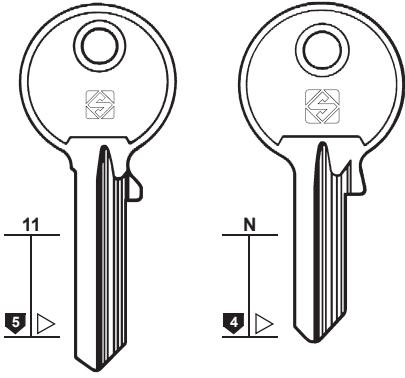

JOW3R

JOW4R

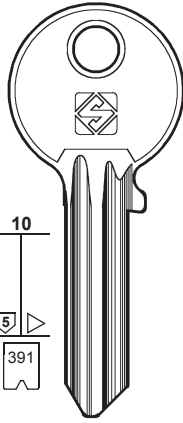

JM3  
A .....  
X .....  
1-2-3-4-5-6-7

JM3R  
 JM2  
 JM2R

F3 JM1  
AY .....  
BA .....  
BB .....  
BC .....  
BD .....  
BL .....  
BM .....  
BN .....  
BP .....  
BQ .....  
BR .....  
BS .....  
BT .....  
BU .....  
BY .....  
F3C .....  
SA .....  
SB .....  
1-6032

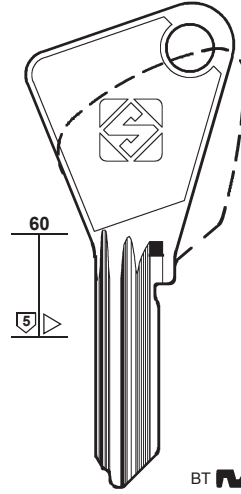

BT JM6

BK JM7



**111**

PER / FOR

**JOWIL (DE)**  
+ EMR (77)  
+ GTV (100)

**JPM (FR)**  
+ ABUS (6-7)  
+ CISA (56)  
+ KESO (115)  
+ SIMECA (170)

**JTF (FR)**  
IJ  
+ IJ (106)  
+ MERONI (137)

**JU (DE)**  
+ KIFERM (117)  
+ VACHETTE (198)

**JUNGHEINRICH (DE)**

**JUNGHWA (JP)**

**JÜNGST (DE)**  
 JOWIL (110)

**JUNIE (DE)**

PER:  
FOR:

**JTF**

**JU**

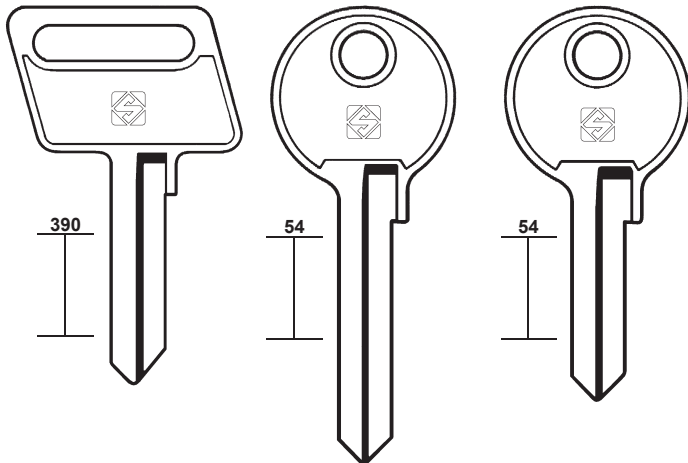

JT1  
JA

JT2R

JT3R

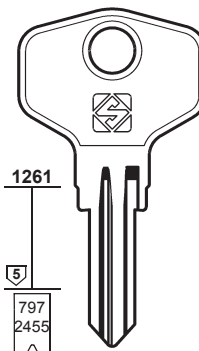

JU11  
D ..... (A) 1-2-3  
B ... (D) 376-500+(507-508)

JU12  
C ..... (B) 1-2-3  
B ... (C) 251-375+(505-506)

JU11R  
A ..... (D) 1-2-3  
B ... (A) 001-125+(501-502)

JU13R  
B ..... (B) 126-250+(503-504)



PER:  
FOR: **JUNGHEINRICH**

**JUNGHWA**

**JUNIE**

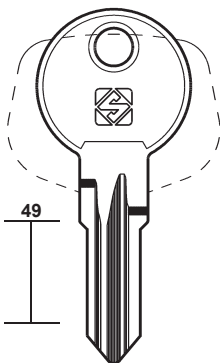

JR1R

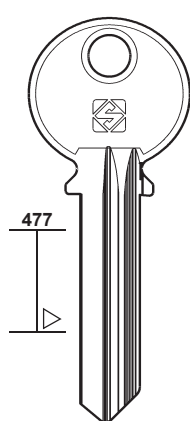

JN1R

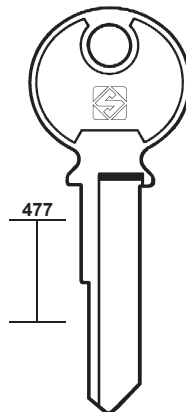

JU5

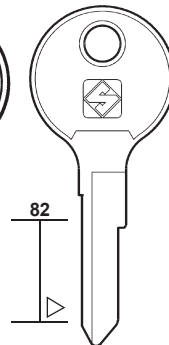

JU9

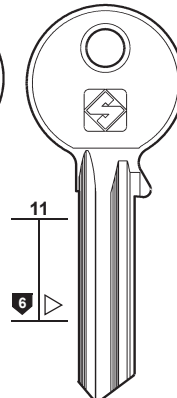

JU3

JU6

JU4

JU8

JU14





# 112

### PER / FOR

**JUNIE (DE)**  
PEROHAUS  
VS

**JUNKUNC (US)**  
ALSO  
AMERICAN  
FEDERAL  
LION

**JUWEL (IT)**  
+ FASEM (86)

**JVAL (PT)**  
FEB  
P.C.  
SAVIO  
+ P.C.  
(CORTELLEZI) (153-154)

PER:  
FOR:

## JUNIE

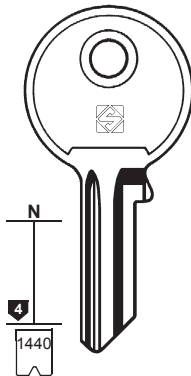
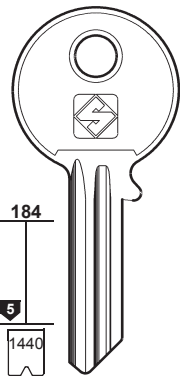

JU2



JU2R



JU1



JU1R

..... 0-1-2-3-4-5-6-7  
NN ..... 2001-2998



JU7



JU10

..... 0-1-2-3-4-5-6-7



PEROHAUS - VS

## JUNKUNC

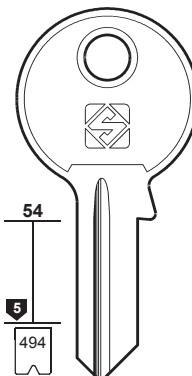
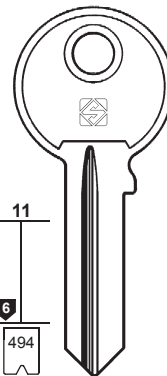

JC2R



JC1

..... 80000-88999

..... 1-2-3-4-5-6-7-8



ALSO - AMERICAN - FEDERAL - LION

PER:  
FOR:

## JUWEL

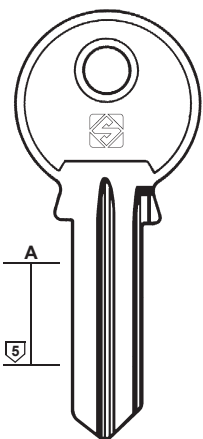

JW13  
16



JW13R  
15



JW12



JW10



JW10R



JW9  
52



JW9R  
53



JW8  
51



JW4  
1



JW4R  
2



JW7  
9



JW7R  
10



JW5  
3



JW5R  
4



JW6  
5



JW6R  
6

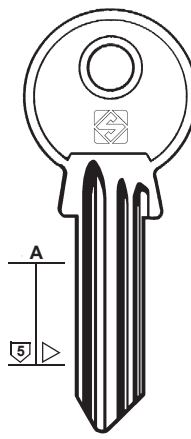

JW1R

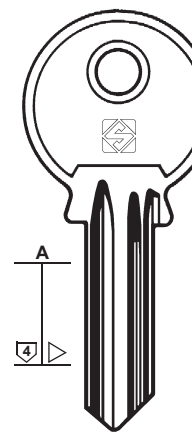

JW2R



JW1



JW2

PER:  
FOR:

## JUWEL

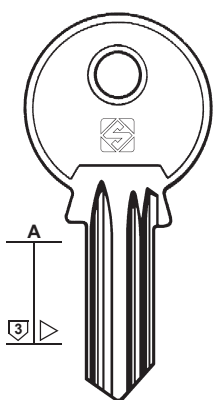

JW3

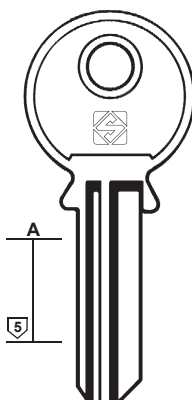

JW11

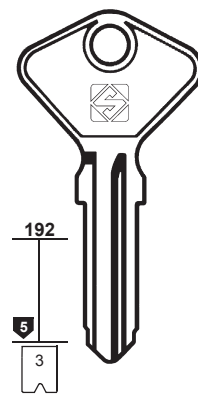

AF4C

6...  
100-309



AF4D

8...  
100-309

## JVAL

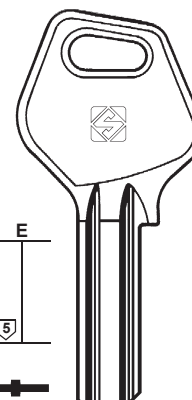

PC13



VL5E



VL5RE



JL3



JL3R

FEB - P.C. - SAVIO

PER:  
FOR:

### JVAL

### KABA

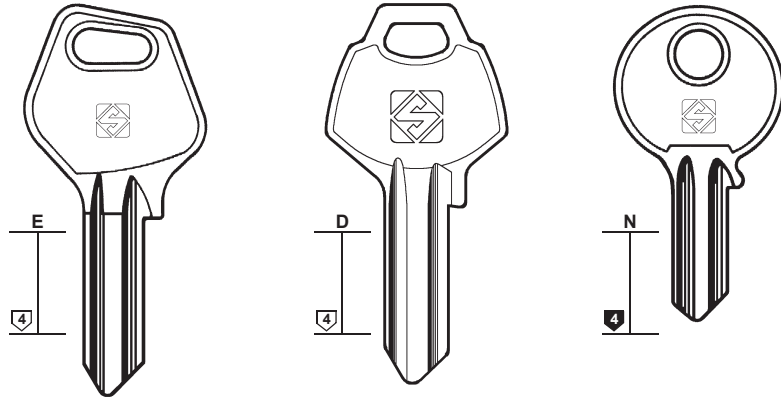

JL5

JL2 JL2R

JL1

VL2RE

JL4 JL4R

FEB - P.C.

FEB

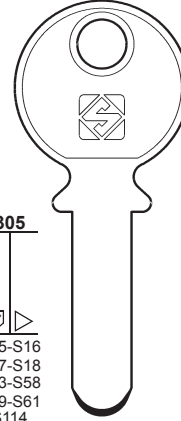

305

S15-S16  
S17-S18  
S53-S58  
S59-S61  
S114

PH ...  
0001-9000  
... 1-200

KA1  
8

mm 2  
LÄSBOLAGET



# 113

PER / FOR

**JVAL** (PT)  
FEB  
P.C.  
+ PC.  
(CORTELLEZI) (153-154)

**KABA** (CH)  
BORKEY  
DORSET  
LÄSBOLAGET  
PICARD

**KAIXI** (CN)

PER:  
FOR:

### KABA

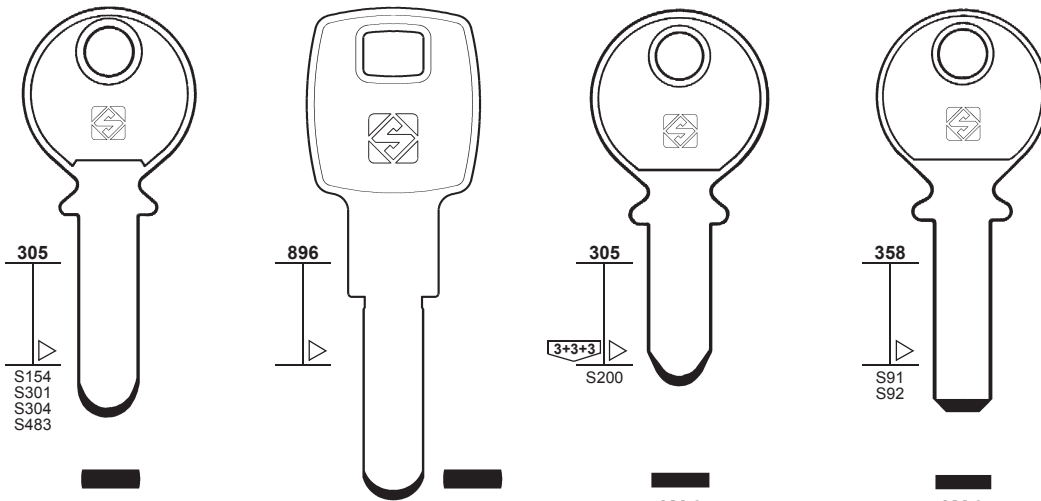

305

896

305

358

S154  
S301  
S304  
S483

3+3+3  
S200

S91  
S92

KA2  
20

KA7

KA6

KA3  
MINI KABA

mm 2,5  
PICARD

BÖRKEY

PER:  
FOR:

### KABA

### KAIXI

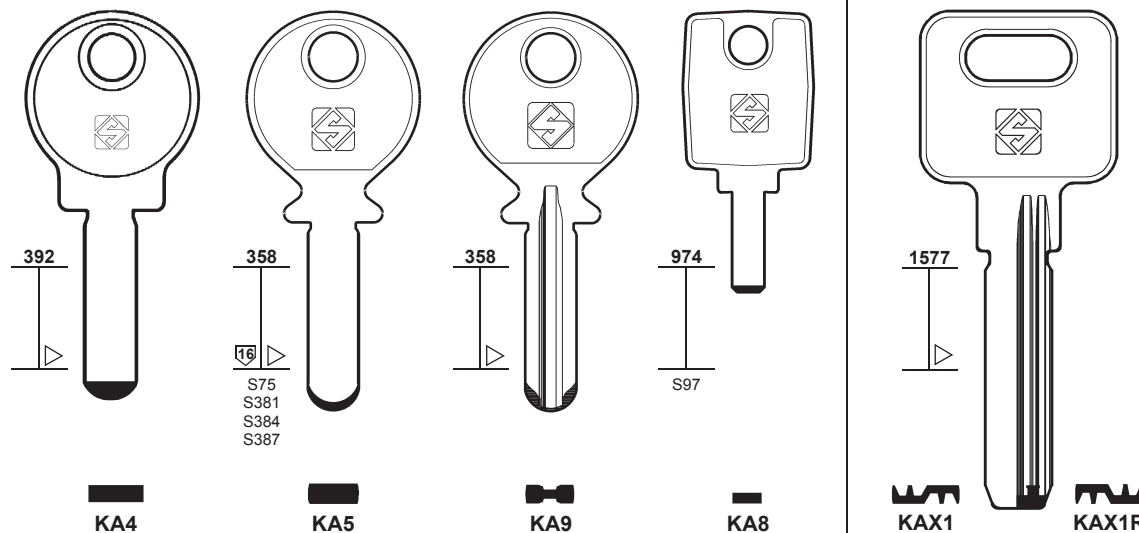

392

358

358

974

1577

S75  
S381  
S384  
S387

S97

KA4

KA5  
GEMINI

KA9

KA8  
MICRO KABA

KAX1

KAX1R

DORSET

LÄSBOLAGET

KAIXI

LÄSBOLAGET



# 114

PER / FOR

**KAKEN** (KR)

**KALE** (TR)

- + ABUS (7)
- + BUVA (44)
- + TESA (182)

**KALUGA** (RU)

**KARDEX** (FR)

- CES (47)
- RONIS (161)
- VINCO (205)

**KARO** (ES)

- FTH (92)

**KASPIJSK** (RU)

**KATE** (DE)

- SIMECA (170)

**KAWE** (DE)

- CORBIN (60)
- TESA (181)
- WEISER (208)

PER: **KAKEN**

FOR:

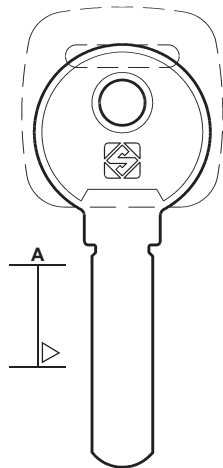

**KAK1**



PER: **KALE**

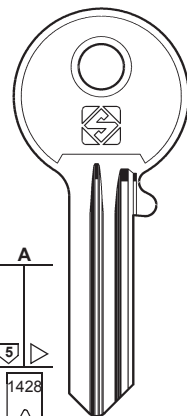

**KLE3R**

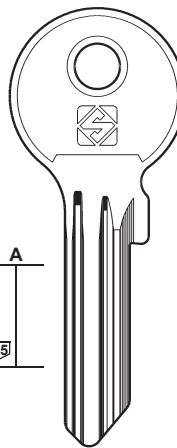

**KLE3X**



**KLE3RX**

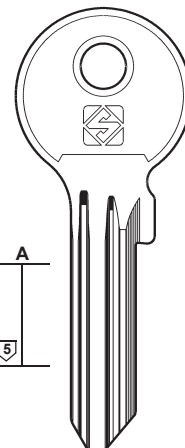

**KLE6X**



**KLE6RX**

4+5

**KLE5X**

**KLE5RX**

**KLE7X**

**KLE7RX**

5  
1428

..... 1-2-3-4-5-6-7-8-9

PER: **KALE**

FOR:

PER: **KALE**

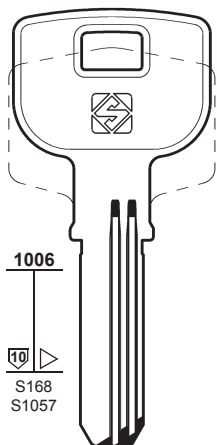

**KLE1**

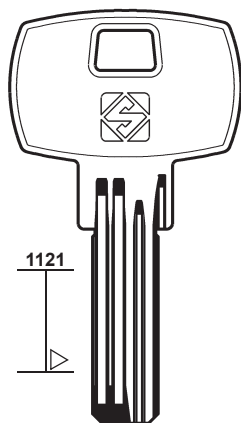

**KLE2R**

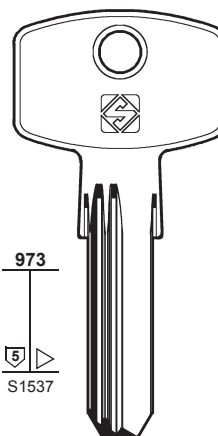

**KLE8R**

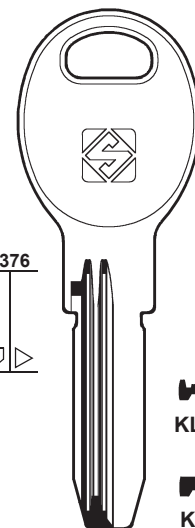

**KLE10R**

**KLE9R**

1006  
S168  
S1057

1121

973  
S1537

1376



PER: **KALE**

FOR:

PER: **KALUGA**

PER: **KASPIJSK**

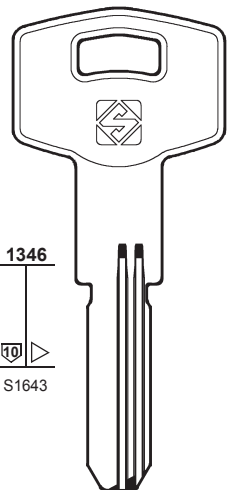

**KLE11**

1346  
S1643

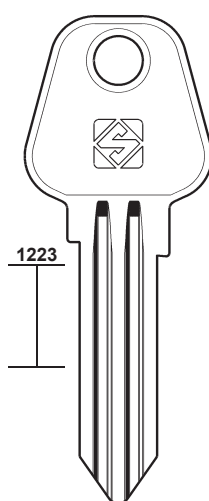

**KLG1R**

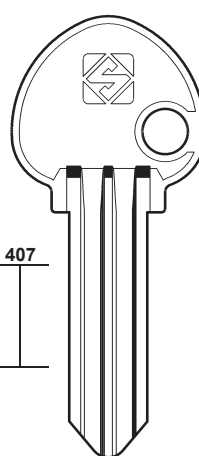

**KLG2R**

407

**RUS2**

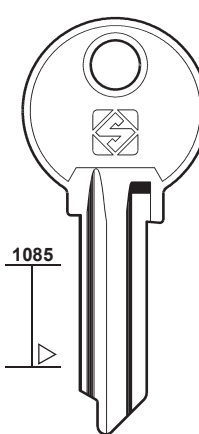

**KAP1**

1085

**KAP1R**

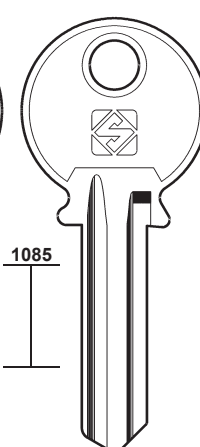

**RUS1**

1085

**RUS1R**



PER:  
FOR:

# KAZAN

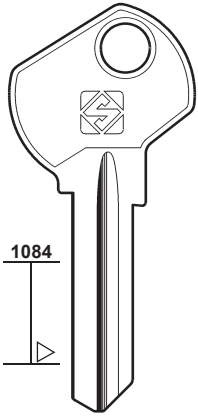

1084

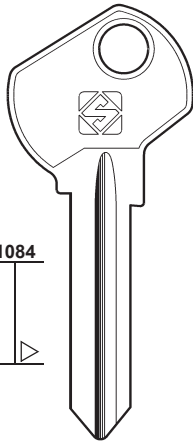

1084

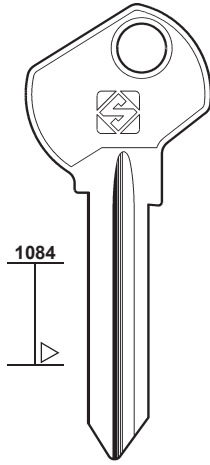

1084

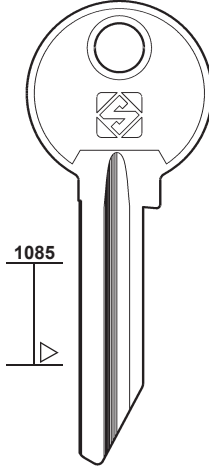

1085

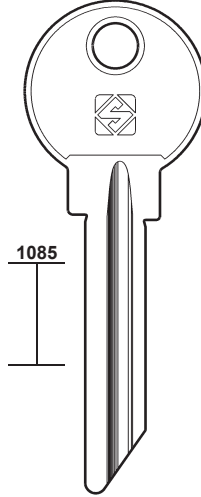

1085



# 115

PER / FOR

**KAZAN (RU)**

**KEIL (US)**

**KESO (CH)**

ALA

JPM

LIPS

SARGENT

PER:  
FOR:

## KAZAN

## KEIL

## KESO

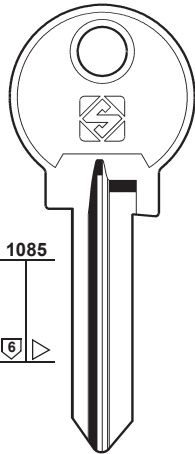

1085

6

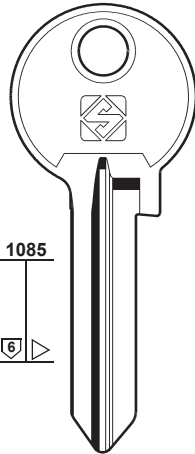

1085

6

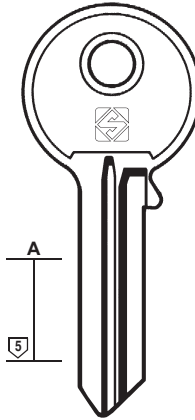

A

5

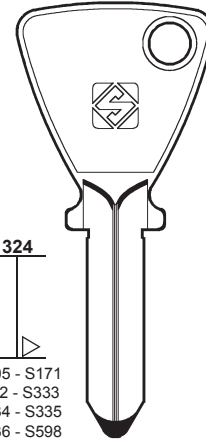

324

S105 - S171  
S332 - S333  
S334 - S335  
S336 - S598  
S599 - S600  
S601 - S678  
S259 - S807



PER:  
FOR:

## KESO

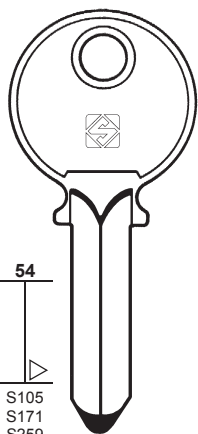

54

S105  
S171  
S259  
S332  
S333  
S334  
S335  
S336  
S598  
S599  
S600  
S601

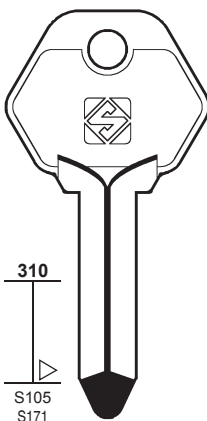

310

S105  
S171  
S259  
S332  
S333  
S334  
S335  
S336  
S598  
S599  
S600  
S601



**SARGENT**

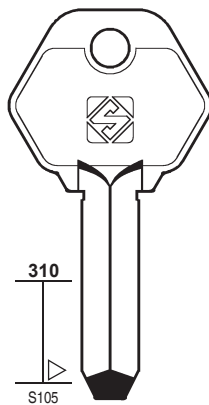

310

S105



**LIPS**

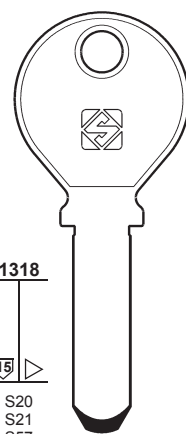

1318

15

S20  
S21  
S57  
S267  
S273  
S277  
S359  
S1298



**ALA**

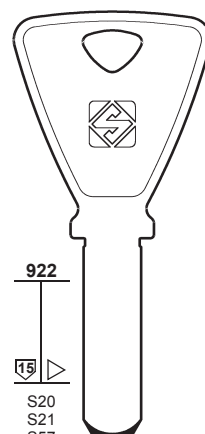

922

15

S20  
S21  
S57  
S267  
S273  
S277  
S359  
S663  
S1298



**JPM**



# 116

PER / FOR

**KESO** (CH)  
FIAM

**KEYA** (ES)  
+ MELSMETALL (136)

**KEYRACK** (DE)

**KFV** (DE)  
COMBA  
FCV  
FLIETHER  
GIESCHE  
GÖTZ  
GRAF  
HSA  
NICO  
SCHÜCO  
SEN

**KHARKOV** (UA)

PER:  
FOR:

## KESO

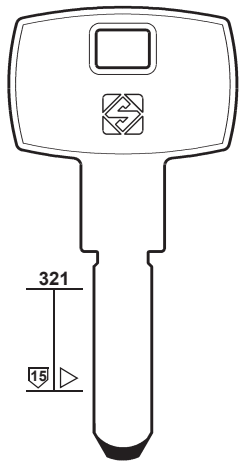

321  
15

KE11

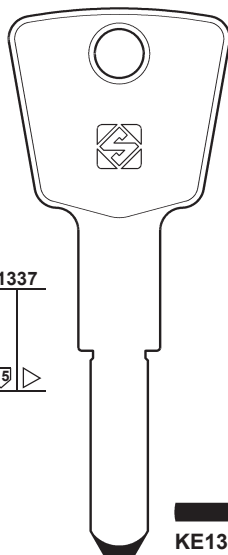

1337  
15

KE13

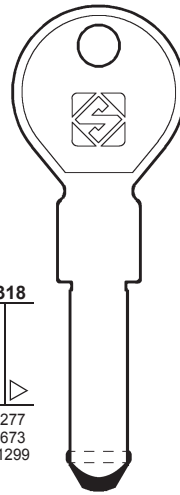

1318  
S277  
S673  
S1299

KE19

2000 S Omega  
2000 S (STEP-DRILLING)



FIAM



## KEYA

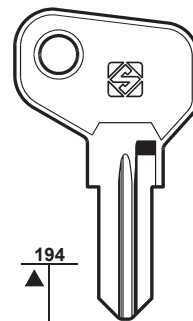

194  
5

KEY1

KEY1R

PER:  
FOR:

## KEYA

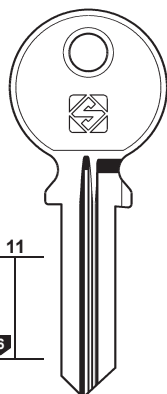

11  
5

KEY2

## KEYRACK

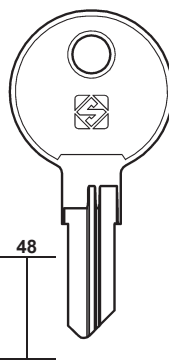

48

KER1

## KFV

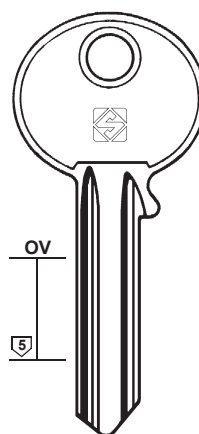

OV  
5

KF1

- |  |  |
|--|--|
|  |  |
|  |  |
|  |  |
|  |  |
|  |  |
|  |  |
|  |  |
|  |  |
|  |  |
|  |  |

COMBA - FCV - FLIETHER  
GIESCHE - GÖTZ - GRAF - HSA  
NICO - SCHÜCO - SEN

PER:  
FOR:

## KHARKOV

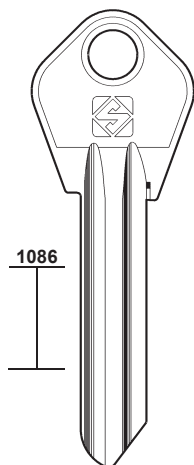

1086

HAK1

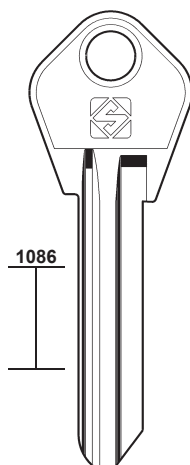

1086

HAK2 HAK6

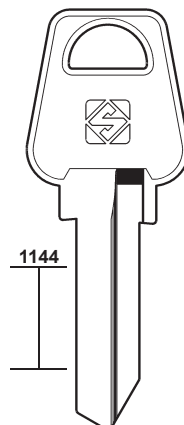

1144

HAK3

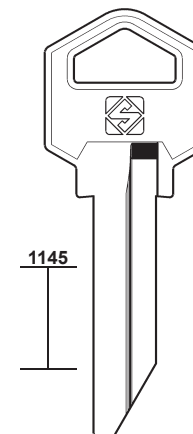

1145

HAK4

PER:  
FOR:

## KIENZLE

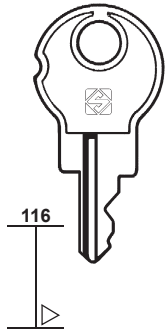

**KZ1**

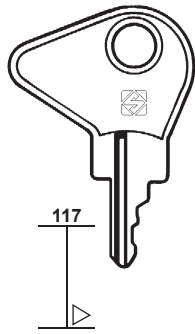

**KZ2**  
1

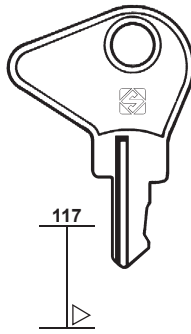

**KZ3**  
2

VDO

## KIEV

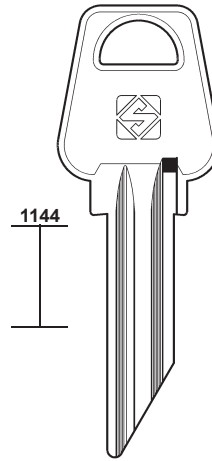

**MTZ1**

METIZ



# 117

PER / FOR

**KIENZLE (DE)**  
VDO

**KIEV (UA)**  
METIZ

**KIFERM (FR)**  
ATAL  
CASH-BOX  
DEF  
GB  
HÄFELE  
IJN  
JU  
LAS  
METEOR  
ORDO  
RENZ  
SEIM  
TEEN HAAF  
WESCO  
+ LAS (121)  
+ RICOUARD (160)

**KILT (FR)**  
VACHETTE (198)

**KIMA (DE)**  
CES (47)

**KIND (DE)**  
CES (47)  
HOPPE (103)

PER:  
FOR:

## KIFERM

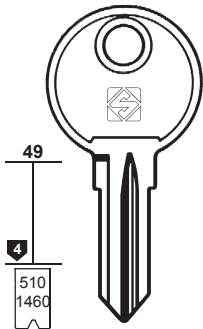

**KI4**  
... 1-50  
... 167  
X ... 167

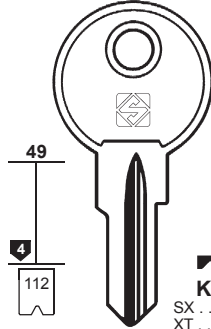

**KI5R**  
SX ... 1-275  
XT ... 1-75  
RX ... 1-275

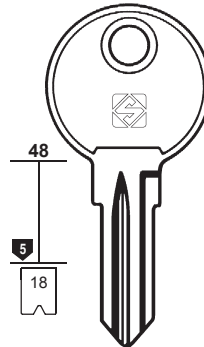

**KI8**      **KI8R**  
W ... 1-224      Z ... 1-224

**KI12**      **KI12R**  
... 151-218      ... 1-68  
... 101-150      ... 51-100  
... 1116-7776      H ... 500-574  
H ... 1116-7776      E ... 1116-7776  
E ... 425-499

**KI7**  
XY ... 1-275

**KI7R**

ATAL - IJN - JU  
LAS - METEOR  
RENZ - TEEN HAAF

**KI10**      **KI10R**  
Y ... 1-224      C ... 1-224  
                         CA ... 1-224  
DEF - GB  
LAS - ORDO

PER:  
FOR:

## KIFERM

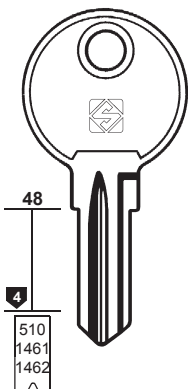

**KI9**      **KI9R**  
... 226-293      ... 76-143  
... 1-2-3      CASH-BOX  
F ... 80-130  
... 258

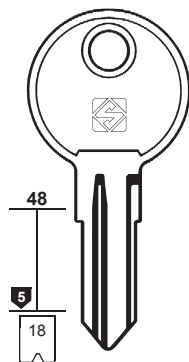

**KI13**  
P ... 1-224

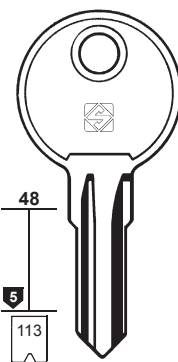

**KI16**  
EX ... 1-224

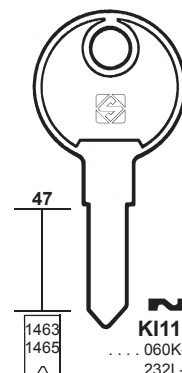

**KI11R**  
... 060K-K660  
... 232L-L332

**KI14**      **KI11**  
TL ... 1-50      ... 232K-K332

**KI15**      **KI15R**  
S ... 1-20      T ... 1-20

DEF - HÄFELE  
LAS - WESCO

LAS



LAS

SEIM



# 118

PER / FOR

**KING** (TW)

**KIROVSMACH** (RU)

**KISHINEV** (MD)

**KITTY** (TW)

ABLOY (4)

**K+K** (IT)

TAMPALINI (179)

**KKL** (AT)

WB

**KMF** (GR)

**KNAPP** (DE)

CES (47)

**KNAUS** (GB)

EURO LOCKS (80)

**KOBE** (RU)

**KOPAT** (ex YU)

**KÖNIG** (DE)

VIRO (205)

**KOVER** (DE)

EMKA (77)

**KP** (RU)

**KRAMATORSK** (UA)

**KREMENCHUK** (UA)

**KROST** (DE)

BUS (44)

**KUNERT** (DE)

CISA (57)

**KURZEMES** (LV)

AISPUTE (13)

PER: FOR:	KING	KIROVSMACH	KISHINEV	
	 132      54  <b>KG1</b> <b>KG2</b>	 1302  <b>KIR1</b>	 1088      1088  <b>KIV1R</b> <b>KIV2R</b>	
PER: FOR:	KKL	KMF	KOBE	KOPAT
	 10  <b>KL1</b> <b>KL1R</b> <b>KL2</b> <b>KL2R</b> <b>WB</b>	 A  <b>KM1</b> <b>KM1R</b>	 1085  <b>KOB1</b>	 454  <b>KP1</b>
PER: FOR:	KP	KRAMATORSK	KREMENCHUK	
	 1102  <b>KPP1</b>	 1141  <b>KMT1</b> <b>KMT2R</b>	 1087  <b>KRE1</b>	



PER:  
FOR:

### KVR

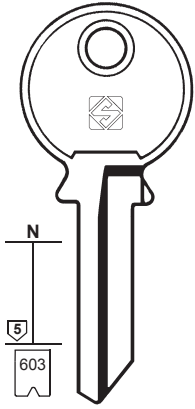

..... 1576-1725



CA9

CAP - PROTEC

### KWIKSET

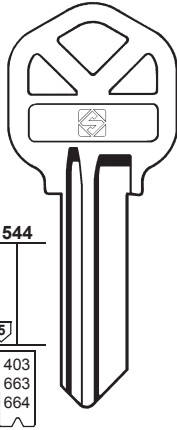

KS1

0-1-2-3-4-5-6-7  
1-2-3-4-5-6-7  
1-2-3-4-5-6-7-8-9

BRICARD - E-Z-SET - MASTER - VACHETTE

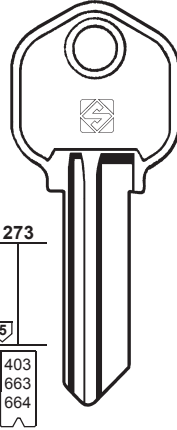

KS1FT

0-1-2-3-4-5-6-7  
1-2-3-4-5-6-7  
1-2-3-4-5-6-7-8-9

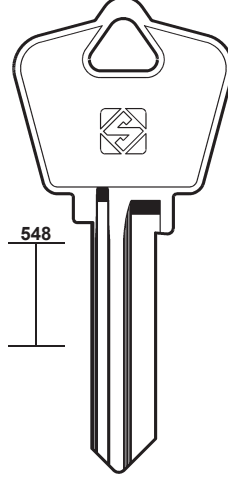

KS4



# 119

PER / FOR

KVR (DE)  
CAP  
PROTEC

KWIKSET (US)  
BRICARD  
E-Z-SET  
MASTER  
VACHETTE

KYNNARPS (GB)

KYR (IT)  
SECURITAL (167)

LABOFA (NL)  
GEGE (94)

LADA (RU)

LA FONTE (BR)

PER:  
FOR:

### KYNNARPS

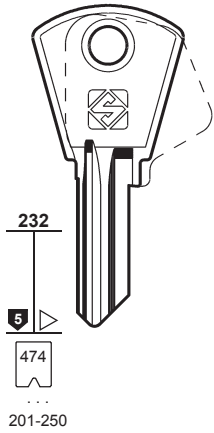

..... 201-250



KNA1

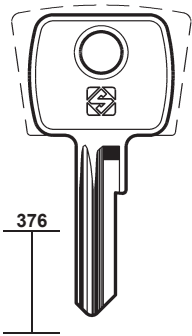

KNA2

### LADA

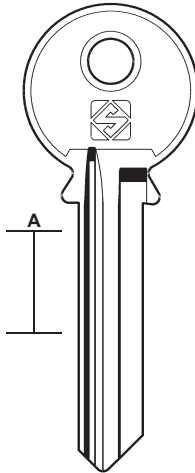

LD4

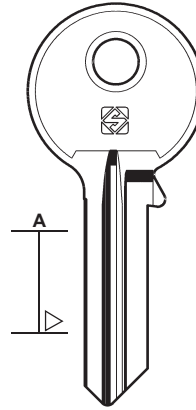

LD4R



LD5R

PER:  
FOR:

### LA FONTE

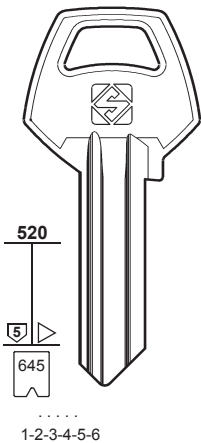

..... 1-2-3-4-5-6



LAF1

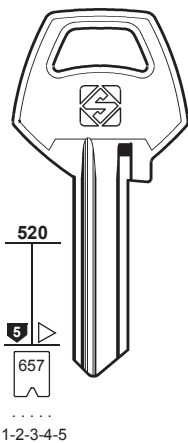

..... 1-2-3-4-5



LAF2

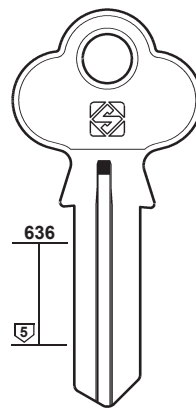

LAF4R



# 120

PER / FOR

**LA FONTE** (BR)

**LAGRANGE** (US)

+ ILLINOIS (106)

**LAMA** (ex YU)

+ MERONI (136)

+ TITAN (183)

**LAMPA** (US)

+ CEMA (46)

**LANE** (AU)

+ CORBIN (62)

**LAPERCHE** (FR)

+ CAS-CISMA (45)

+ DOM (68)

+ RONIS (161)

PER:  
FOR:

## LA FONTE

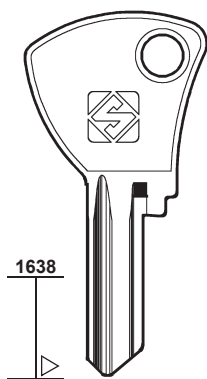

1638



LAF5

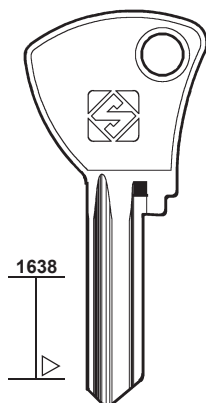

1638



LAF6

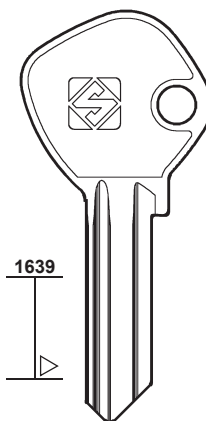

1639



LAF7

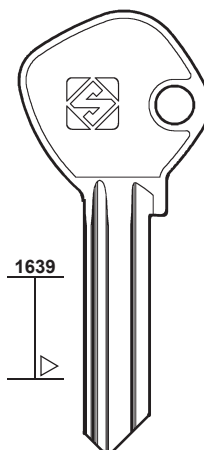

1639



LAF8

PER:  
FOR:

## LAMA

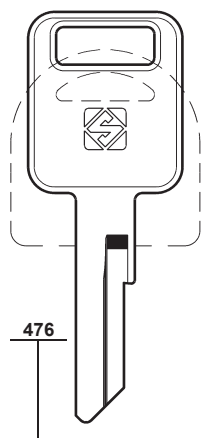

476



LMA1



## LAPERCHE

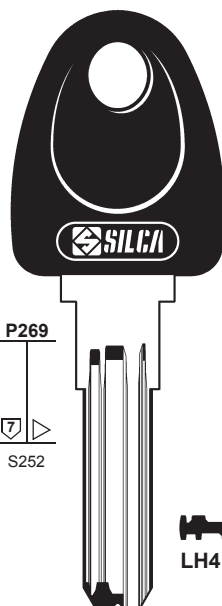

P269

S252



LH41P

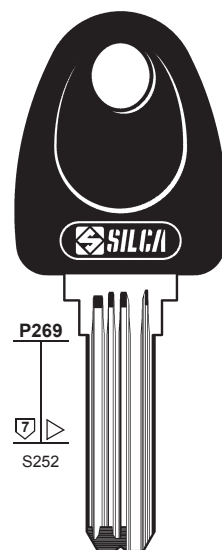

P269

S252



DIAM



LH13P



LH16P



LH14P



LH17P



LH15P



LH18P

PER:  
FOR:

## LAPERCHE

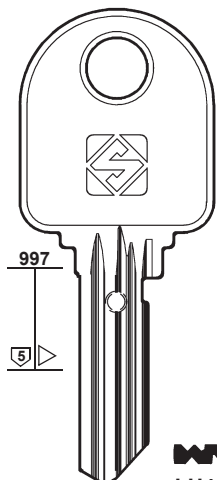

997



LH43R

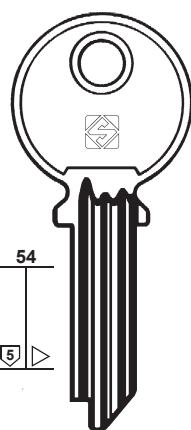

54



LH1  
DM

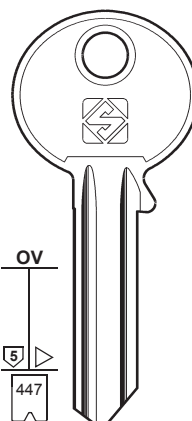

OV

447



LH4

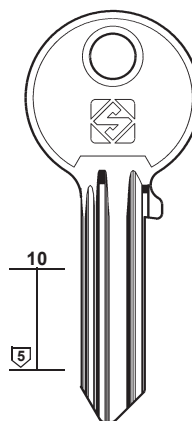

10



LH40

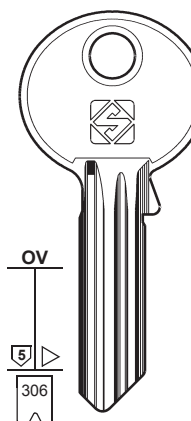

OV

306



LH42  
L0 . . . . . 1-9999

C0 . . . . . 1-1000  
C1 . . . . . 1-1000  
C2 . . . . . 1-1000  
C3 . . . . . 1-1000  
B0 . . . . . 1-1000  
B1 . . . . . 1-1000  
B2 . . . . . 1-1000  
B3 . . . . . 1-1000

PER:  
FOR:

# LAPERCHE

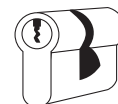

# 121

PER / FOR

**LAPERCHE (FR)**  
 + CAS-CISMA (45)  
 + DOM (68)  
 + RONIS (161)

**LA PORTE (DE)**

DLP  
 GHE  
 PRESTA  
 + BOMORO (37)  
 + DLP (67)

**LAREDO (ES)**

+ YALE (212)

**LARK (TW)**

+ GLOBE (97)

**LAS (FR)**

ATAL  
 DUBOIS  
 HÄFELE  
 KIFERM  
 MARCADET  
 PK  
 RENZ  
 RONIS  
 STRAFOR  
 WESCO  
 + KIFERM (117)  
 + RICOUARD (160)

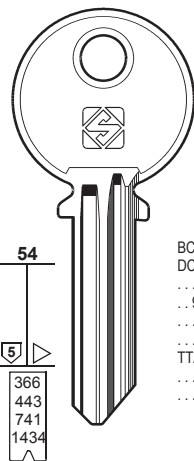

**LH5**

..... 0-1-2-3-4-5-6-7-8-9  
 ..... 1-2-3-4-5-6-7-8-9  
 TTP ..... 0-1-2-3-4-5-6-7-8-9  
 ..... 1-2-3-4-5-6-7-8-9



**LH5R**

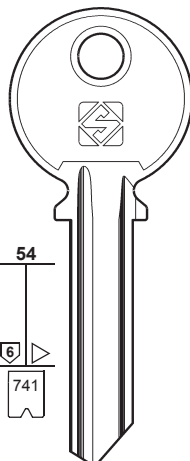

**LH10**

..... 0123456789  
 UUP .....  
 0123456789



**LH10R**

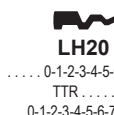

**LH20**

..... 0-1-2-3-4-5-6-7-8-9  
 TTR .....  
 0-1-2-3-4-5-6-7-8-9



**LH2**

BC ..... 1001-3865  
 DC ..... 1001-3865  
 ..... 1-2-3-4-5-6-7-8-9  
 ..... 1-2-3-4-5-6-7-8-9  
 ..... 15001-16000  
 ..... 16001-18125  
 TTA ..... 0-1-2-3-4-5-6-7-8-9  
 ..... 13001-13500  
 ..... 1001-3865



**LH2R**

..... 1-2-3-4-5-6-7-8-9  
 ..... 1-2-3-4-5-6-7-8-9



**LH21**

..... 0-1-2-3-4-5-6-7-8-9  
 TTS .....  
 0-1-2-3-4-5-6-7-8-9



**LH22**

..... 0-1-2-3-4-5-6-7-8-9  
 TTT .....  
 0-1-2-3-4-5-6-7-8-9



**LH23**

..... 0-1-2-3-4-5-6-7-8-9



**LH24**



**LH25**

UUR .....  
 0-1-2-3-4-5-6-7-8-9



**LH6R**

UUS .....  
0-1-2-3-4-5-6-7-8-9



**LH3**

UUA .....  
 0-1-2-3-4-5-6-7-8-9



**LH26**

UUS .....  
0-1-2-3-4-5-6-7-8-9



**LH27**

UUT .....  
0-1-2-3-4-5-6-7-8-9



**LH28**

UUV .....  
0-1-2-3-4-5-6-7-8-9



**LH29**

UUX .....  
0-1-2-3-4-5-6-7-8-9

PER:  
FOR:

# LA PORTE

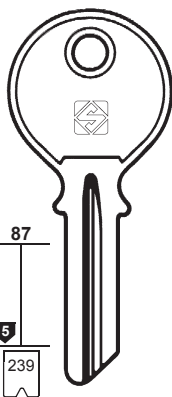

**LAP1**

..... 7200-7399  
 ..... 1001-1052

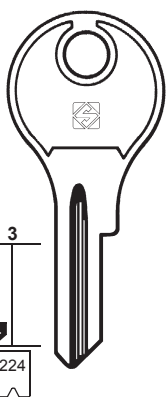

**DL1R**

..... 2501-2550

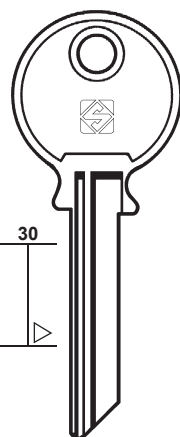

**LAP3**

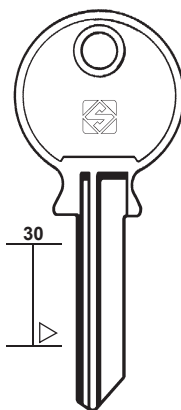

**LAP2**

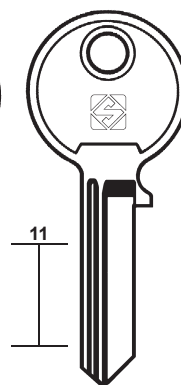

**DL3**

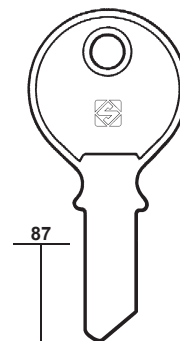

**DL2**



GHE - PRESTA



DLP

PER:  
FOR:

# LAS

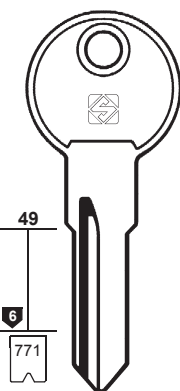

**LS3**

A ... 1-650

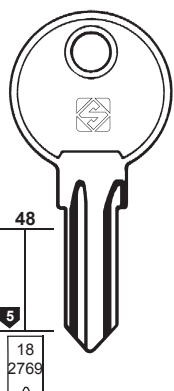

**LS1**

R ... 1-224

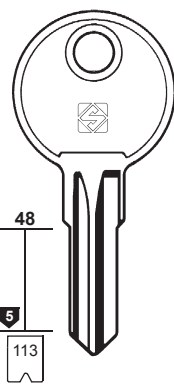

**LS2**

AX ... 1-224

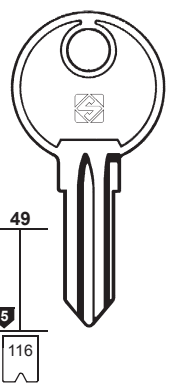

**LS7**

FH ... 1-400  
 LH ... 1-400  
 FH ... 501-550

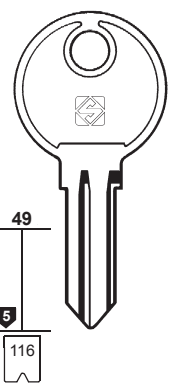

**LS19**

FH ... 1-400  
 LH ... 1-400  
 FH ... 501-550

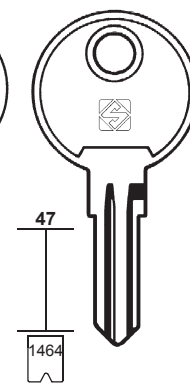

**LS12**

LS ... 1-60



**LS10**

AB



DUBOIS - KIFERM  
 PK - RENZ  
 RONIS - WESCO



ATAL - HÄFELE  
 KIFERM  
 MARCADET - RENZ



**LS4**

U



**LS4R**

X

STRAFOR



# 122

### PER / FOR

#### LAS (FR)

ABBES  
FORT  
MARCADET  
ORDO  
RONIS  
+ KIFERM (117)  
+ RICOUARD (160)

#### LÅSBOLAGET (SE)

TANLOCKS  
+ KABA (113)  
+ SIS (170)

#### LAUDON (ZA)

L & F (129)

#### LBLM (ES)

FORTIS (90)

#### LE FEBURE (US)

CIFIAL (53)

#### LEGALLAIS (FR)

HB

#### LEGG (GB)

#### LEHMANN (DE)

MLM  
+ MLM (141)

#### LEN-LOK (AU)

ROLL-A-DOOR  
+ LOCKWOOD (126)

#### LG (FR)

ARROW (20)

PER:  
FOR:

## LAS

47 47 401 421 403

545  
206

6

5

116

116

LS5 L

LS6 L231

LS9 AT... 1-650

LS9R TA... 1-650

LS11 RM... 1-2000  
KT... 3001-4000  
TK... 7001-8000

LS17 PR

LS14 MJ... 1-400  
FM... 1-100  
SM... 1-400  
MR... 001-050  
FM... 501-550  
SM... 501-550

LS13 JH... 1-100  
FH... 1-400  
LH... 1-400  
SH... 1-400  
WH... 1-400  
AA... 1-50  
LH... 1-60  
... 301-675  
FH... 501-500

FORT

LS13R FM  
SH...  
501-550

LS14R

LS15

LS18 PM... 1-10

MARCADET - RONIS

ABBES - ORDO

PER:  
FOR:

## LÅSBOLAGET

405 288

4

5

590

591

6543210

X09876V

LB11

LB10

LB19

LB18

LB23

LB22

LB33

LB32

LB35

LB34

LB28

LB29

TANLOCKS

TANLOCKS

## LEGALLAIS

210 11

6

5

S905

1-2-3-4-5-6

LEA1

LEA2

HB

PER:  
FOR:

## LEGG

54 66

5

5

415

..... 1-2-3-4-5-6-7

LEG1

LEG2

LEG3 PASSEPARTOUT

## LEHMANN

1567

5

S1559

MLM9

MLM

## LEN-LOK

462

LL1

LL

ROLL-A-DOOR

PER:  
FOR:

# LINCE

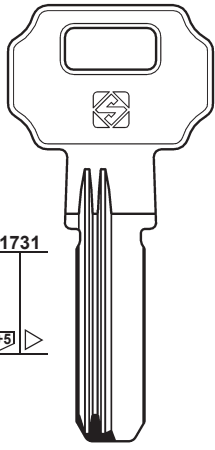

**LC26R**

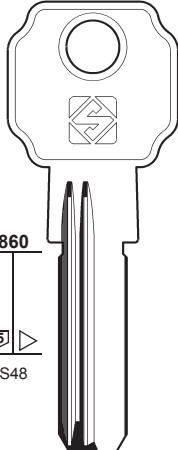

**LC14R**  
X

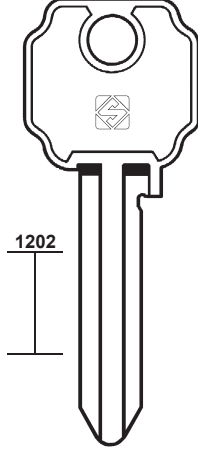

**LC10**  
K

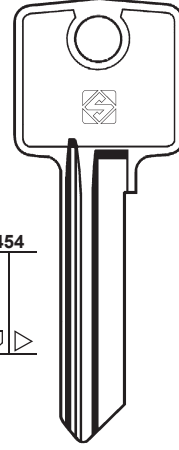

**LC7**  
M

**LC7R**  
M

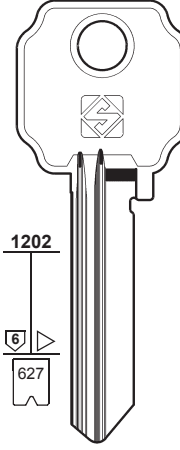

**LC15**  
S

**LC15R**  
S

.....  
1-2-3-4-5-6-7-8



ICSA



# 123

PER / FOR

**LINCE (ES)**  
ICSA  
+ ALPHA (16)

**LION (US)**  
JUNKUNC (112)

**LIONA-LIOX (FR)**  
RONIS (161)

PER:  
FOR:

# LINCE

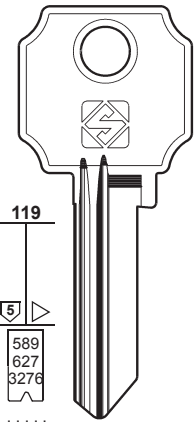

.....  
1-2-3-4-5-6-7-8

**LC1**  
A

**LC1R**  
A

**LC2**  
C

**LC2R**  
C

**LC11**  
R

**LC11R**  
R

**LC12**  
B

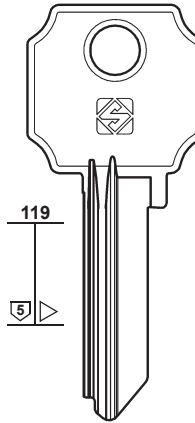

**LC25**

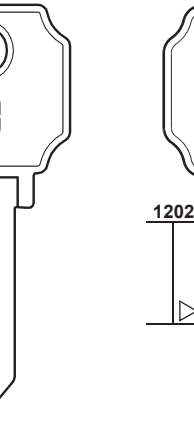

**LC25R**

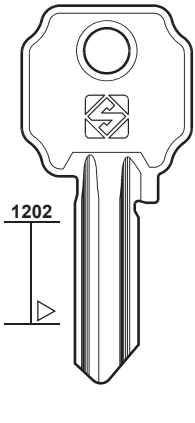

**LC16**  
U

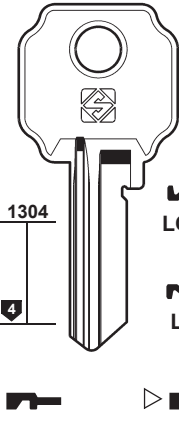

**LC13R**  
D1

**LC13**  
D1

**LC8**  
T

**LC3**  
D

**LC8R**  
T

**LC3R**  
D



mm 50-60-70



mm 30-40

PER:  
FOR:

# LINCE

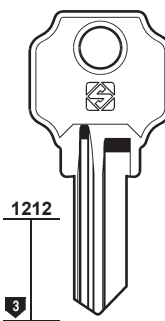

**LC17R**

**LC17**

**LC9**

**LC4**  
E

**LC9R**

**LC4R**  
E

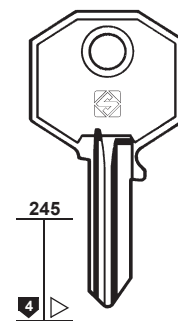

**LC6**  
J

**LC6R**  
J

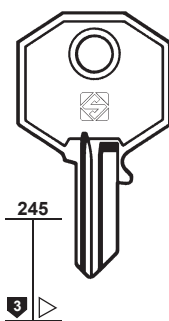

**LC5**  
F

**LC5R**  
F



mm 30-40



mm 25



mm 20



# 124

PER / FOR

LIPS (NL)  
+ DALWA (64)

PER:  
FOR:

## LIPS

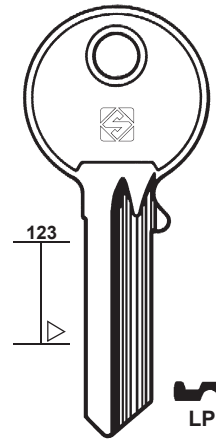
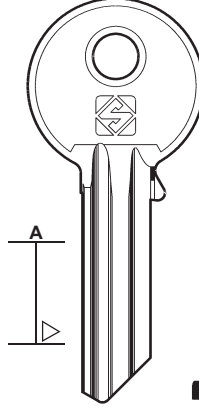
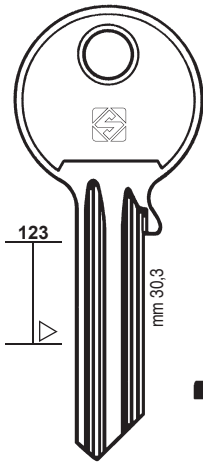

PER:  
FOR:

## LIPS

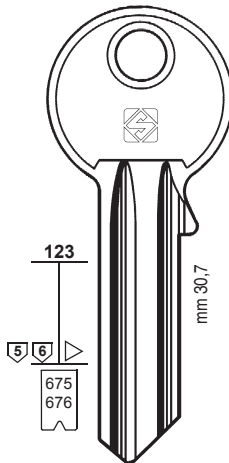

.....  
1-2-3-4-5-6-7-8-9-0  
A-B-C-D-E-F-G-H-I-L

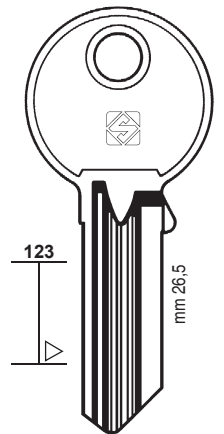
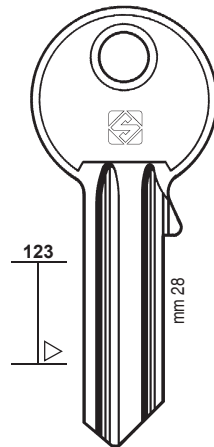

PER:  
FOR:

## LIPS

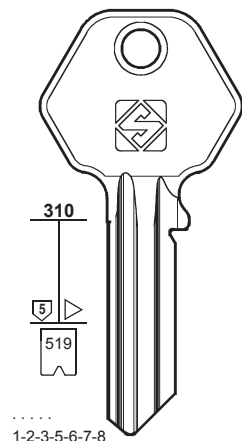

.....  
1-2-3-5-6-7-8

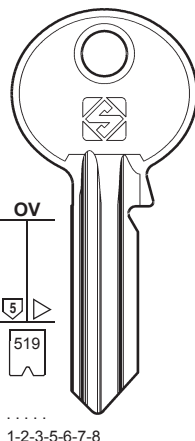

.....  
1-2-3-5-6-7-8

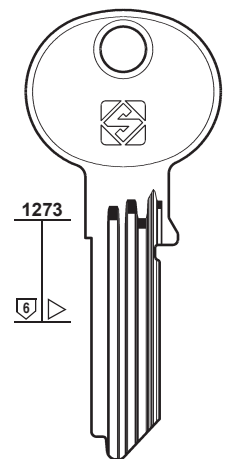
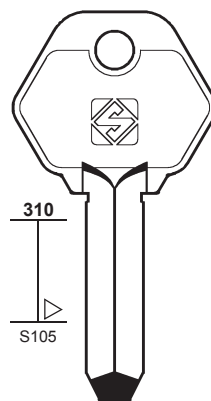

PER:  
FOR:

### LIPS

### LITTO



# 125

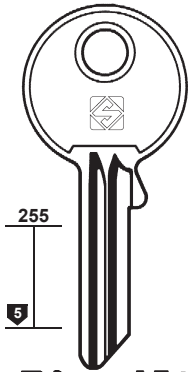

**LP14**  
19

**LP14R**  
18

**LP15**  
21

**LP15R**  
20

**LP16**  
17

**LP16R**  
16

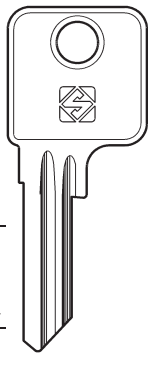

**LP6**

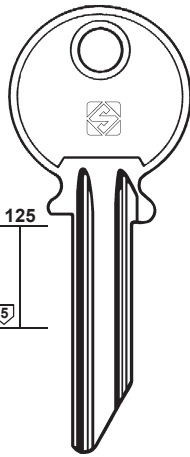

**LT1**

**BKS**

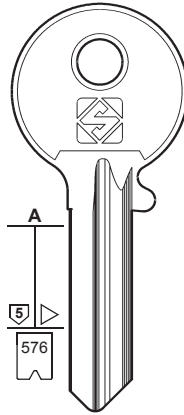

**LT2**  
E

00E001-05E999

1-2-3-5-6-7-8-9-0

**ANKERSLOT**

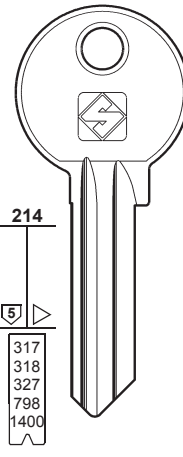

**CB6**

..... 012345678

..... 123456

DX ..... 123456

..... 123456789

..... 876543210

**CORBIN**

PER / FOR

**LIPS (NL)**

+ DALWA (64)

**LIPS-VAGO (IT)**

+ PREFER (157)

**LISTA (DE)**

+ DOM (69-70)

**LITTO (BE)**

ANKERSLOT

BKS

CORBIN

+ ANKERSLOT (17)

+ CORBIN (60)

**LM (SE)**

+ TEKA (181)

**L.M.C. (DE)**

+ HUWIL (104)

**LML (IT)**

+ MORI E. (142)

**LN (BR)**

**LOB (PL)**

ROSTEX

+ FAB (82)

+ MCM (134)

PER:  
FOR:

### LITTO

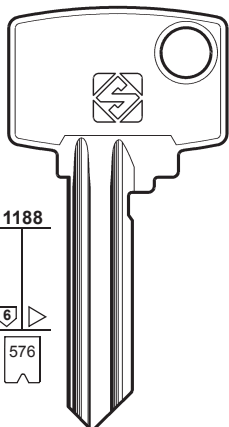

**LT3**

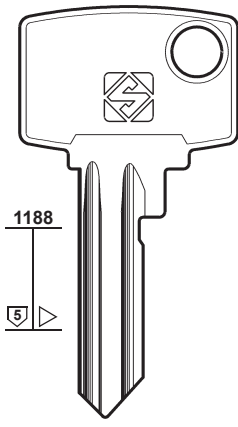

**LT4**

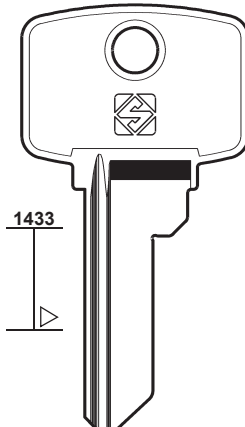

**LT5**

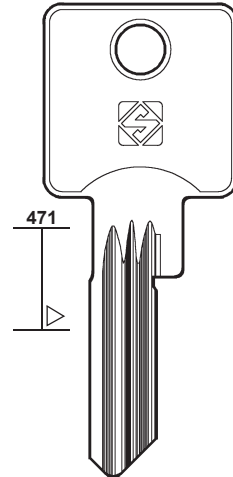

**LT6R**

PER:  
FOR:

### LN

### LOB

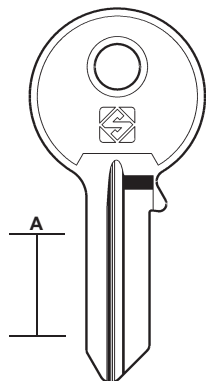

**LN1**

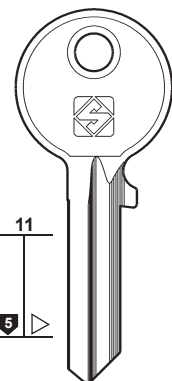

**LOB1**

**LOB1R**

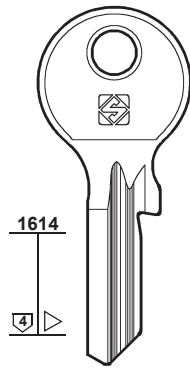

**LOB9R**

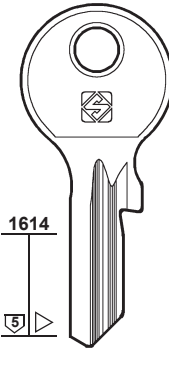

**LOB10R**

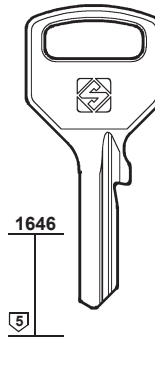

**LOB11R**

ROSTEX



# 126

### PER / FOR

**LOB (PL)**  
BRICARD  
EXPRES  
REDY  
YETI

+ FAB (82)  
+ MCM (134)

**LOCKSYS (BG)**

**LOCKWELL (BR)**

**LOCKWOOD (AU)**  
LEN-LOK

PER:  
FOR:

## LOB

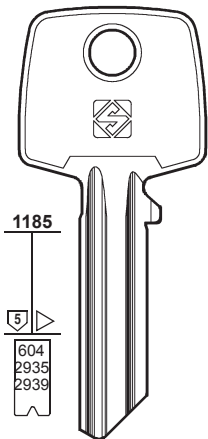

..... 0123456789  
..... 123456789ABC



**LOB16**

YETI

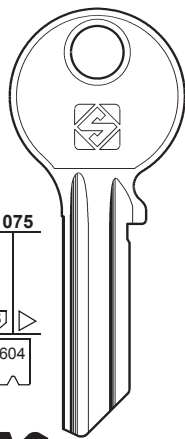

**YT16**



**YT15**



**YT15R**

..... 0-1-2-3-4-5-6-7-8-9

**BRICARD - EXPRES  
REDY - YETI**

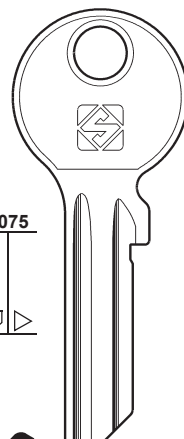

**YT16X**



**YT15X**



**YT15RX**

YETI

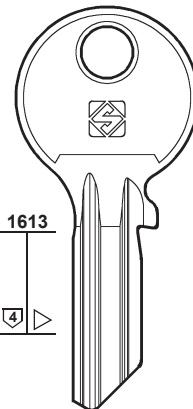

**LOB13**

PER:  
FOR:

## LOCKSYS

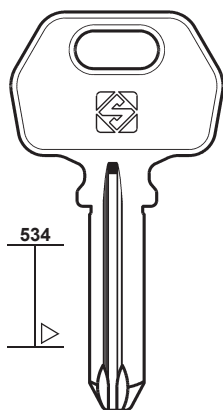

**LCK1R**

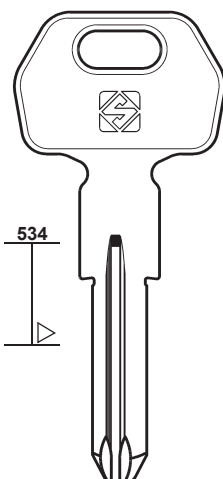

**LCK1RX**



## LOCKWELL

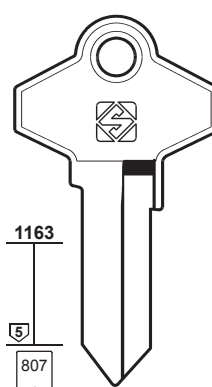

..... 1-2-3-4-5-6-7-8



**LOC1**

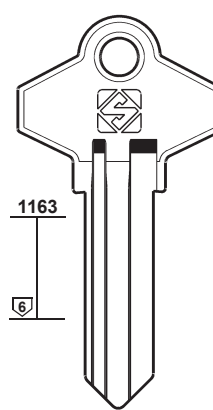

**LOC3**

PER:  
FOR:

## LOCKWELL

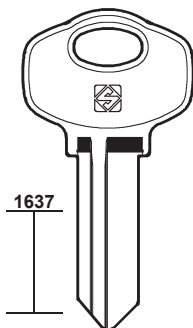

**LOC4**

## LOCKWOOD

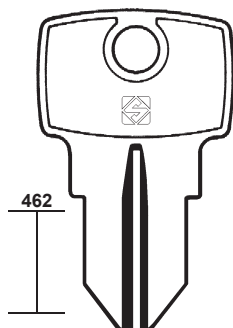

**LL1**  
LL

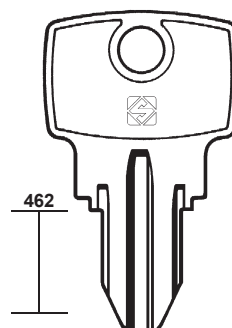

**LW16**  
R



**LW17**  
N

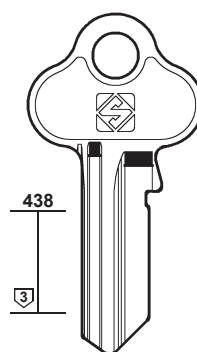

**LW34**

LEN-LOK



PER:  
FOR:

# LOCKWOOD



# 127

PER / FOR

**LOCKWOOD (AU) (US)**  
GAINSBOROUGH

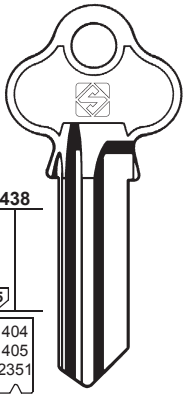

**LW4**  
..... 0123456789A  
B ... 1-100  
C ... 1-100  
D ... 1-100  
E ... 1-100  
A ... 1-40  
FG ... 1-826

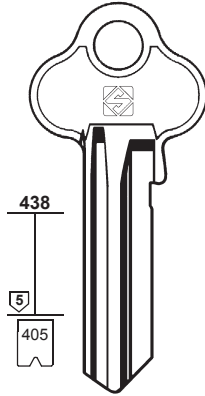

**LW4R**  
..... 0123456789A

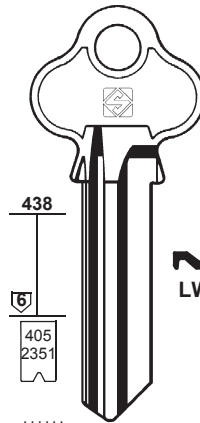

**LW6** AB  
**LW7** AC  
**LW8** AD  
**LW9** AE  
**LW10** BC  
**LW11** DE

..... 0123456789A

**LW20**  
..... 0123456789  
X ... 100-27787  
HX ... 1000-1500

**LW20R**  
..... 0123456789

**LW40** .....  
**LW40R** .....  
0-1-2-3-4-5-6-7-8-9-A

**LW5** .....  
**LW5R** .....  
..... 0123456789A  
B ... 1-100  
D ... 1-100  
F ... 1-100  
A ... 1-40  
C ... 1-40

GAINSBOROUGH

PER:  
FOR:

# LOCKWOOD

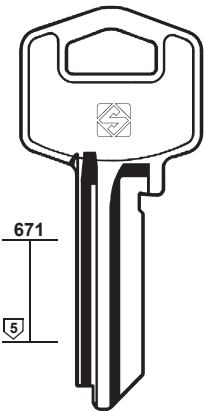

**LW18**

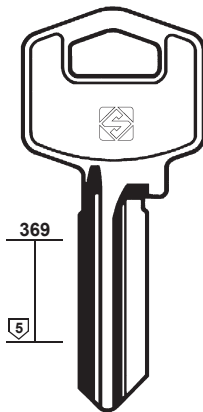

**LW19**

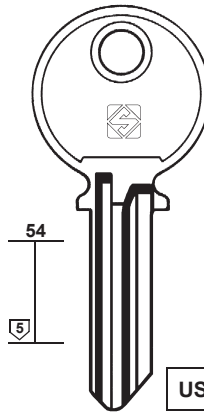

**LW2** **LW2R**

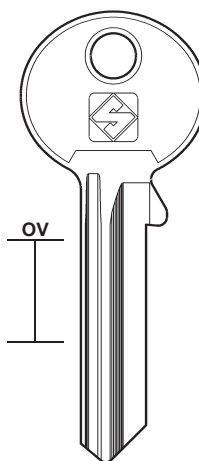

**LW24**

PER:  
FOR:

# LOCKWOOD

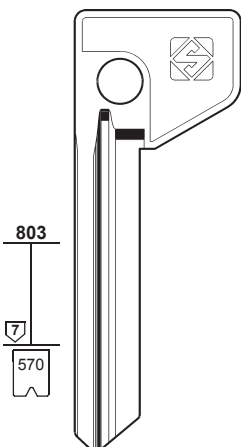

**LW21R**  
.....  
0-1-2-3-4-5-6-7-8-9-A

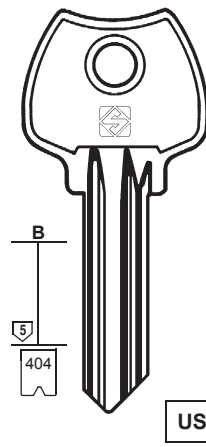

**LW1** **LW1R**  
.....  
0-1-2-3-4-5-6-7-8-9

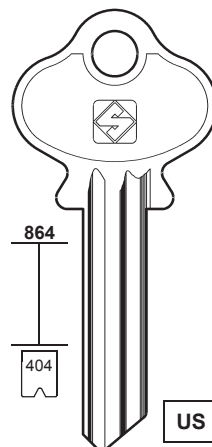

**LW23**  
..... 0123456789

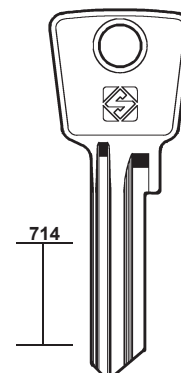

**LW28**  
..... 1-3720  
..... 3001-6720  
..... 456789A





# 128

PER / FOR

**LOCKWOOD** (AU) (US)

**LOGO** (IT)

+ CISA (55-57)

**LOK 2000** (IT)

+ CISA (57)

**LORI** (US)

+ EAGLE (75)

**LOTUS** (TW)

+ YETI (218-219)

**L & F** (GB)

ATAL  
DAD  
DOUBLE SAFE  
EURO LOCKS  
IBFM  
MIBRA  
TELFORD  
ULTRA  
UTZ  
+ CHICAGO (52)  
+ EURO LOCKS (78-79)

## LOCKWOOD

PER:  
FOR:

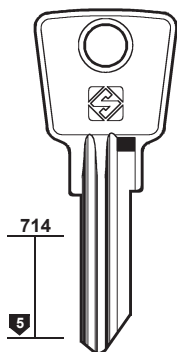

**LW14**  
24A

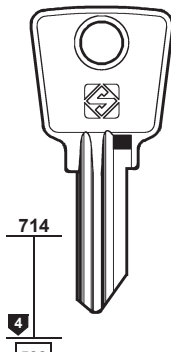

**LW3**  
... 1-960  
L... 1-960  
L... 151-250

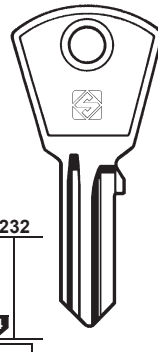

**LW15**  
... 1-2100

**LW13**  
CL ... 1-1000

**LW12R**  
Y ... 1-960



## LOK 2000

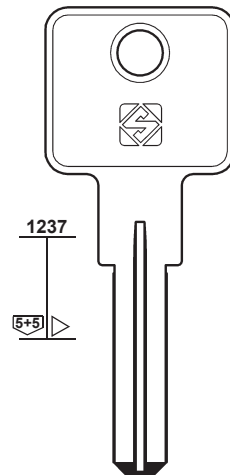

**LOK2**



## LOWE & FLETCHER

PER:  
FOR:

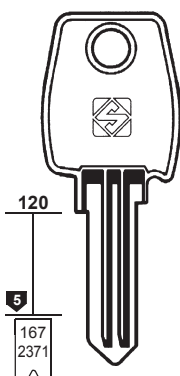

**LF2**  
G ... 1001-5000  
... 31001-32000  
... 31001-33000  
... 32001-33000  
... 36001-38000  
... 38001-38999  
... 77001-77500  
... 87001-91000  
... 95000-99000  
... 5001-9000

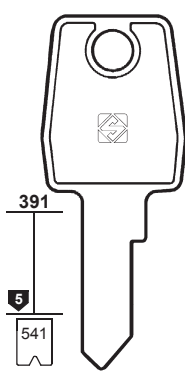

**LF13**  
... 2001-4000

**LF17**  
ATAL

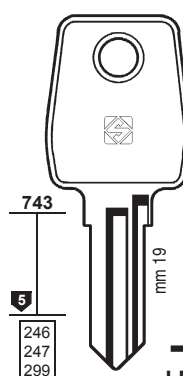

**LF23R**  
EL ... 1-500  
... 1001-1100  
93 ... 401-900  
... 9001-9500  
EL ... 9001-9500

**LF22R**

**LF22**  
93 ... 201-400  
... 93901-94000

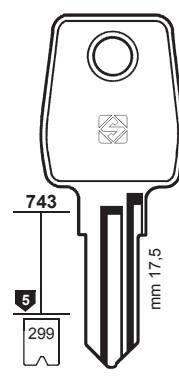

**LF20**  
93901-94000

**LF20R**

**LF16**

**LF26**  
77001-77500  
95000-99000

**LF16R**

**LF15R**  
... 90901-90975



**LF57**

DOUBLE SAFE - EURO LOCKS

DAD - MIBRA - UTZ

UTZ

## LOWE & FLETCHER

PER:  
FOR:

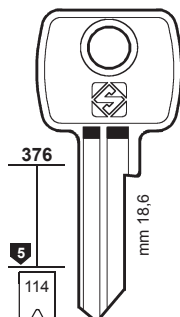

**LF4**  
60 ... 1-400  
90 ... 1-200  
92 ... 1-400  
... 1-400  
GHM ... 1-155  
M ... 1-400  
92 ... 401-600  
99 ... 1-400  
RV ... 1-400  
RVM ... 1-400  
SP ... 1-400  
GS ... 1-400  
... ES1  
... EV1

**LF4R**  
99 ... 401-600  
92 ... 501-700

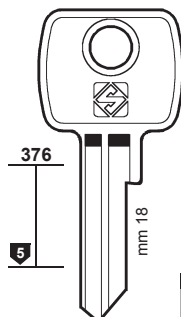

**LF6**  
90 ... 1-200  
... 1-400  
91 ... 201-350  
GH ... 1-400  
SS ... 1-400  
92 ... 401-600  
GS ... 1-400

**LF6R**  
90 ... 1-200  
... 1-400  
91 ... 201-350  
GH ... 1-400  
SS ... 1-400  
92 ... 401-600  
GS ... 1-400

**LF18R**

**LF42R**  
FEE ... 1-100  
NF ... 1-30

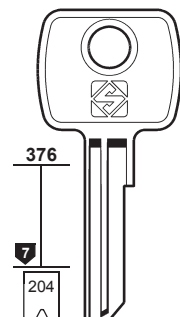

**LF11**  
76 ...  
1-400  
...  
70001-71200  
GH ... 1-400  
SS ... 1-400  
M ...  
70001-71000

**LF11R**

**LF52**

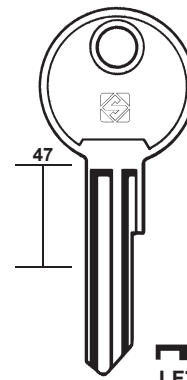

**LF7**

**LF8**

**LF8R**



TELFORD



PER:  
FOR:

### LOWE & FLETCHER

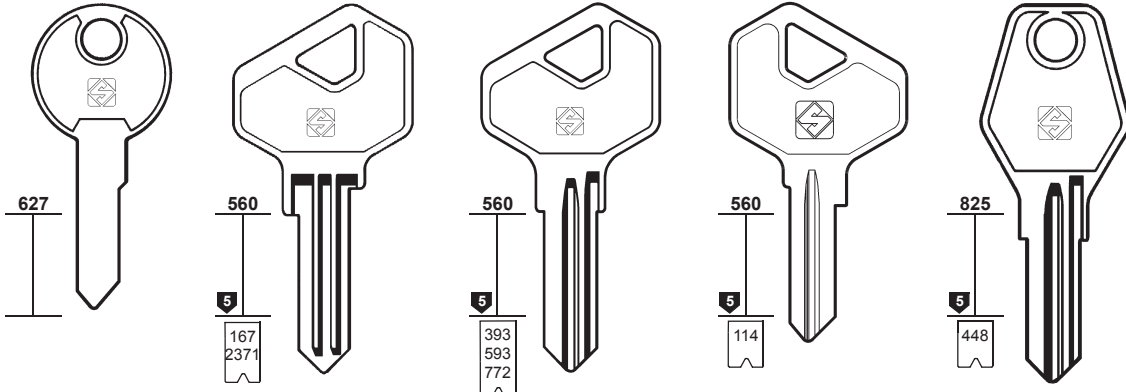

**LF29R**

**LF24**

**LF25**

**LF27** **LF27R**

**LF43R**

**LF37**

V... 1-88  
E... 101-600  
RE... 101-600  
... 5001-9000  
... 31001-33000  
... 36001-38000  
... 87001-91000

419001-419420  
19... 1-420  
... 17001-19000  
... 23001-23400  
... 23001-25100  
... 27001-27400  
... 7001-7400  
... 7001-9000  
... 701-900  
... 1-150

R... 151-650  
T... 1-1000  
S... 1-1000  
... 9001-9494



AUSTRALIA

AUSTRALIA



# 129

PER / FOR

**L & F (GB)**  
BASI  
DAD  
EURO LOCKS  
LAUDON  
ROLL-A-DOOR  
+ CHICAGO (52)  
+ EURO LOCKS (78-79)

PER:  
FOR:

### LOWE & FLETCHER

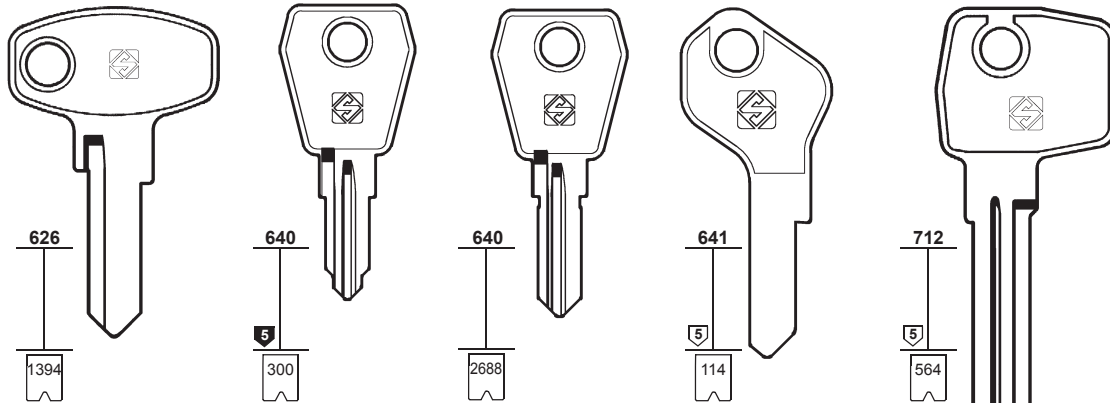

**LF28R**

**LF30R**

**LF61R**

**LF31R**

**LF33**

RO2...  
101-215

... 801-900  
... 901-1000

... 6601-7100

60... 001-400  
... 1-400  
92... 1-400  
M... 1-400  
91... 201-350  
... ES1  
... RV1

68001-70000

**LF51R**

EURO LOCKS  
LAUDON



BASI - DAD



EURO LOCKS

PER:  
FOR:

### LOWE & FLETCHER

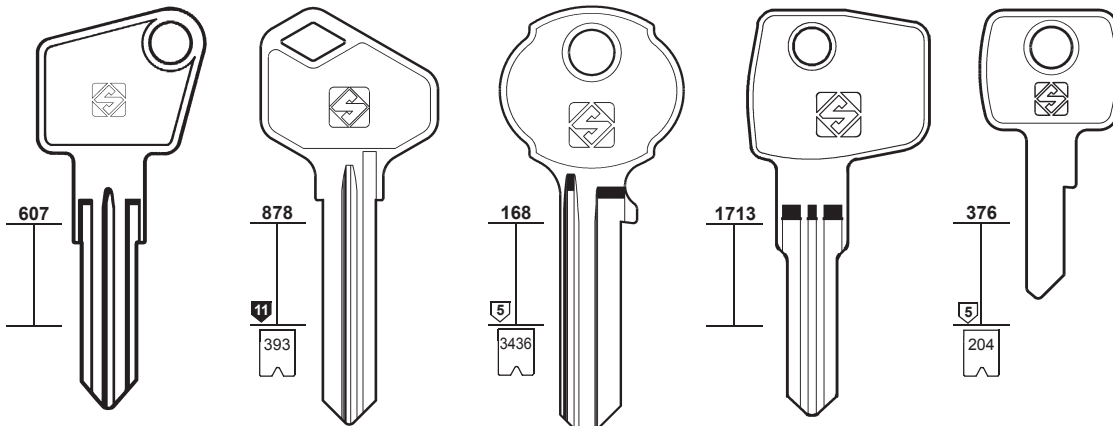

**LF34**

**LF39**

**LF47**

**LF62**

**LF54**

09... 1-900  
29... 1-478

A... 12000-13049

75... 001-200



AUSTRALIA  
ROLL-A-DOOR





# 130

### PER / FOR

#### L & F (GB)

+ CHICAGO (52)

+ EURO LOCKS (78-79)

#### LOXEM (GB)

#### LR (IT)

+ MORI E. (142)

#### LUCO (TW)

+ GLOBE (97)

#### LUCKY (TW)

#### LUMA (ES)

TRELOCK

#### LUME (IT)

+ GIUSSANI (96)

#### LUNA (IT)

+ P.C. (CORTELLEZZI) (153)

#### LUX (EG)

#### LYF (ES)

#### M (IT)

+ CAS-CISMA (45)

#### MAFOR (FR)

+ RONIS (161)

PER:  
FOR:

## LOWE & FLETCHER

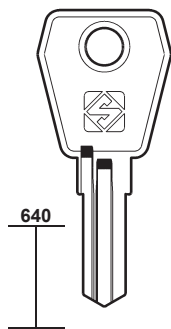

640



LF46R

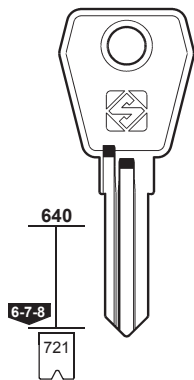

640



LF45R LF53

ME ... 001-300  
..... 18000-18999  
..... 19000-19999  
..... 35000-35499  
..... 78000-78999  
..... 79000-79999

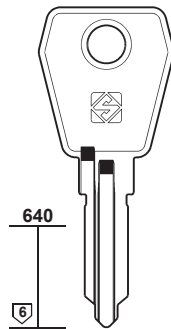

640



LF58R LF59R

AA ... 000-999

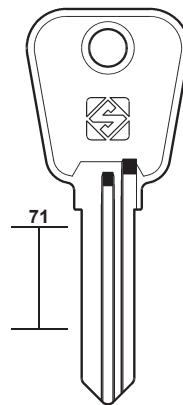

71



LF56



LF44

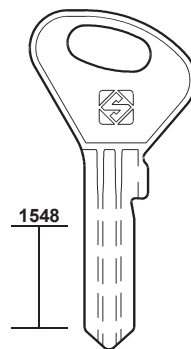

1548



LF60



PER:  
FOR:

## LOXEM

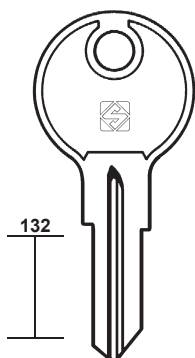

132



LXM1R

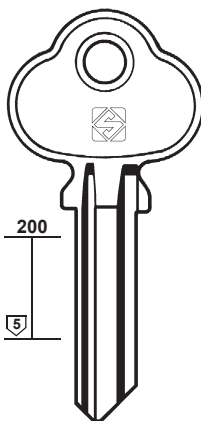

200



LU1

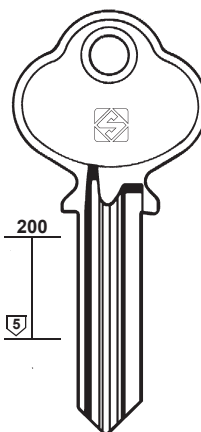

200



LU2

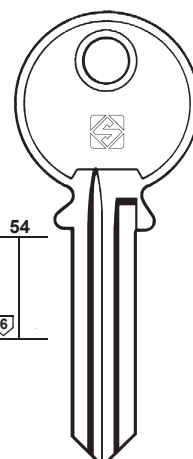

54



LU3R

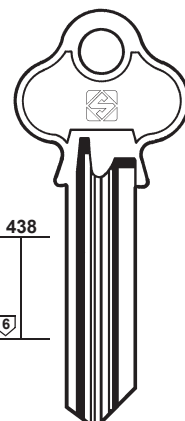

438



LU4

PER:  
FOR:

## LUMA

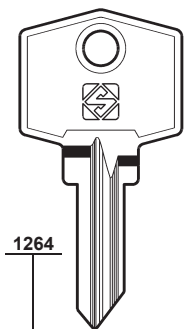

1264



LM3



LM4

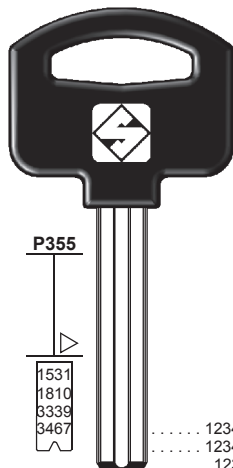

P355

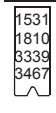

..... 1234  
..... 1234  
..... 1234  
..... 01234



LM5P



## LUX

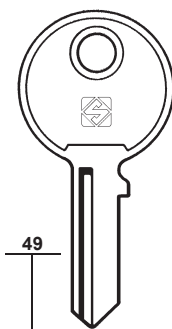

49



LX1



LX1R



## LYF

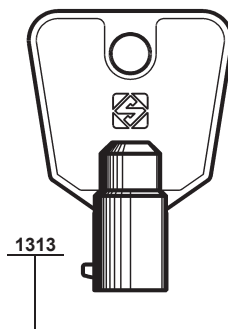

1313



LYF1T

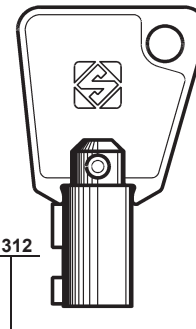

1312



LYF2T

S536  
S818



..... 654321  
..... 76543210

PER:  
FOR:

**MAGNUM**

**MARIANI**

**MARS**

**MASTER**

S1246  
S1261  
S1262  
S1263  
S1378  
S1379  
S1380  
S1381  
S1382  
S1383

MGN1R MGN1RP

MR1

MAR1

MS8



**131**

PER / FOR

**MAGNUM** (GB)

**MAQUET** (FR)  
DOM (70)

**MARCADET** (FR)  
LAS (121-122)

**MARCO** (DE)  
DOM (70)

**MARIANI** (IT)

**MARK** (TW)  
TRI-CIRCLE (190)

**MARLIN** (IT)  
BOSS (37)

**MARS** (TW)

**MASTER** (US)  
HAMPTON  
+ ABUS (8)  
+ KWIKSET (119)  
+ TOK-WINKHAUS (184)

PER:  
FOR:

**MASTER**

MS19 MS17 MS24

..... 01234567  
410K ..... 001-999

MS5R

10T ..... 1-1000

MS13R  
MS9R  
MS4R  
..... 1-9800  
34H ..... 601-912

MS3  
10L ..... 1-1000

MS11

MS10

PER:  
FOR:

**MASTER**

MS16 MS7 MS1 MS12 MS2 MS14

P ..... 1-850  
T ..... 1-3000  
X ..... 1-1500

..... 3201-4000  
A ..... 101-2100  
A ..... 5501-6400  
U ..... 1-3250  
X ..... 2001-3000  
X ..... 5001-6000  
M ..... 2001-4515  
J.U. .... 01-50

mm 30  
**HAMPTON**

MS2  
1K

..... 1-3200  
A ..... 101-2100  
A ..... 5501-6400  
E ..... 1-700  
E ..... 2001-3000  
J ..... 301-1250  
J ..... 2001-2150  
USN ..... 1-4500  
W ..... 0-3500  
WO ..... 1-1000  
X ..... 2001-3000  
X ..... 5001-6000  
..... 4201-5000  
..... 5001-6000  
..... 6001-7000  
..... 7001-8000  
..... 8001-9000  
..... 9001-10000  
M ..... 2001-4515

mm 40  
**HAMPTON**

MS23

MS22



# 132

### PER / FOR

#### MASTER (US)

- + ABUS (8)
- + KWIKSET (119)
- + TOK-WINKHAUS (184)

#### MASTER LOCK (TW)

- + CINA (54)

#### MATTEY (FR)

- + SUREX (178)

#### MAUER LOCKS (BG)

- + DEKABA
- + DEKABA (65)

#### MAUSER (DE)

- + CES (47)
- + HOPPE (103)
- + HUWIL (104)

#### MAXIGARD (FR)

- + GABON (93)

PER: MASTER  
FOR:

P350  
S902

P262

MS20P MS21AP

PER: MASTER LOCK  
FOR:

1577

1295

1295

MSL1 MSL2 MSL3

PER: MASTER LOCK  
FOR:

1716

1716

MSL4R MSL5R

PER: MAUER  
FOR:

1650

1362

MAU1R MAU2

DEKABA

PER: MAUER  
FOR:

1362

1362

1305

MAU3 MAU4 MAU5R

DEKABA

PER:  
FOR:

### MAXUS

### MAY-TAY

### MCM

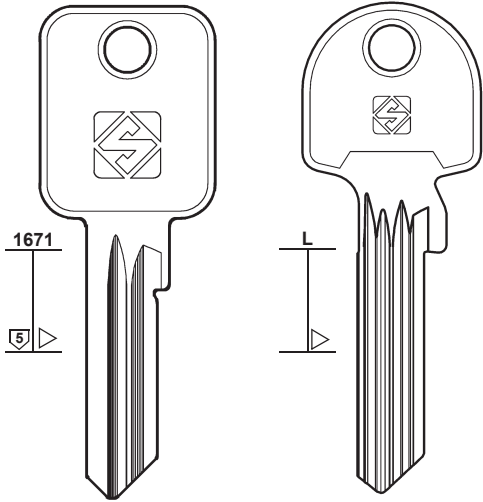

**MXU1R**

**MXU2**

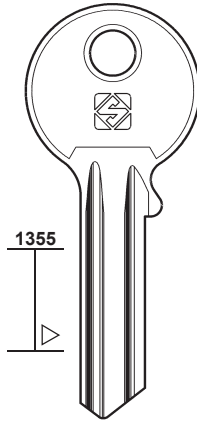

**MAY1**

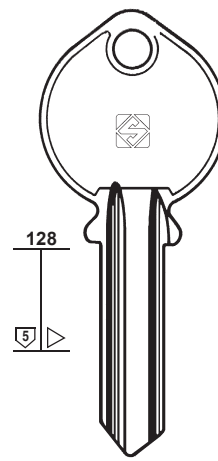

**MC1**

**MC1R**



# 133

PER / FOR

**MAXUS** (GB)

**MAY-TAY** (IL)

**MBB** (DE)  
CES (47)

**MCM** (ES)  
MONDRAGON

PER:  
FOR:

### MCM

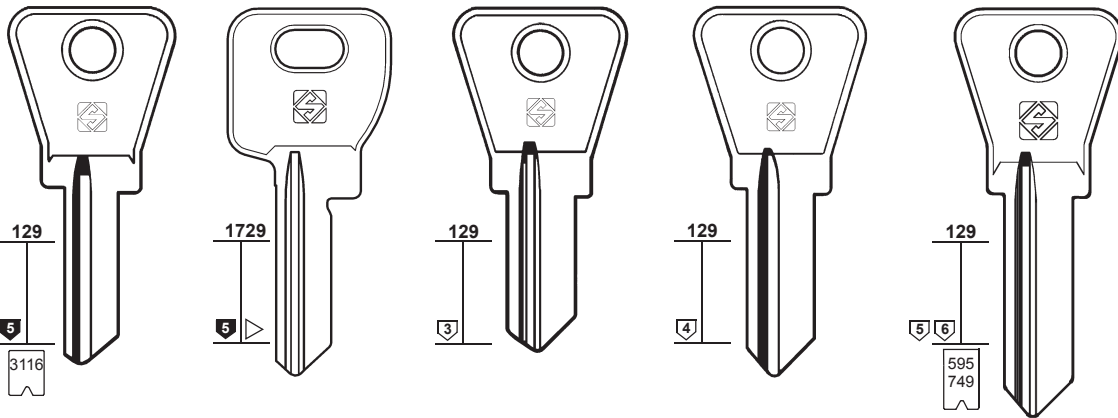

**MC4** **MC4R**

**MC23**

**MC6** **MC6R**

**MC5** **MC5R**

**MC2** **MC2R**

OV .....  
33436-77674

MONDRAGON

1..... 2.....  
1-2-3-4-5-6-7 1-2-3-4-5-6-7  
.....  
0-1-2-3-4-5-6-7

PER:  
FOR:

### MCM

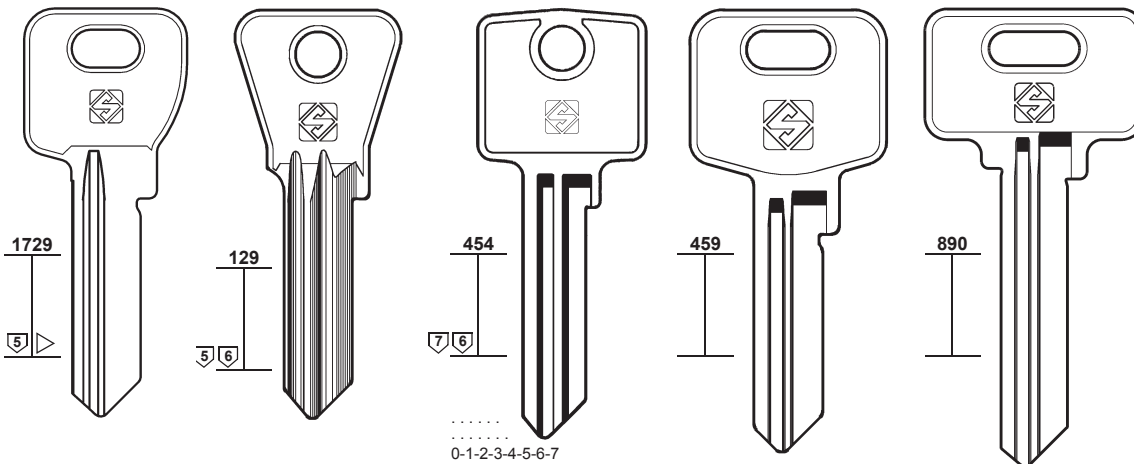

**MC22**

**MC7**

**MC3**

**MC17**

**MC8**

**MC22R**



MONDRAGON



# 134

PER / FOR

MCM (ES)  
GERDA  
LOB  
TROMER  
YETI

MECALUX (FR)  
AGA (11)

PER:  
FOR:

## MCM

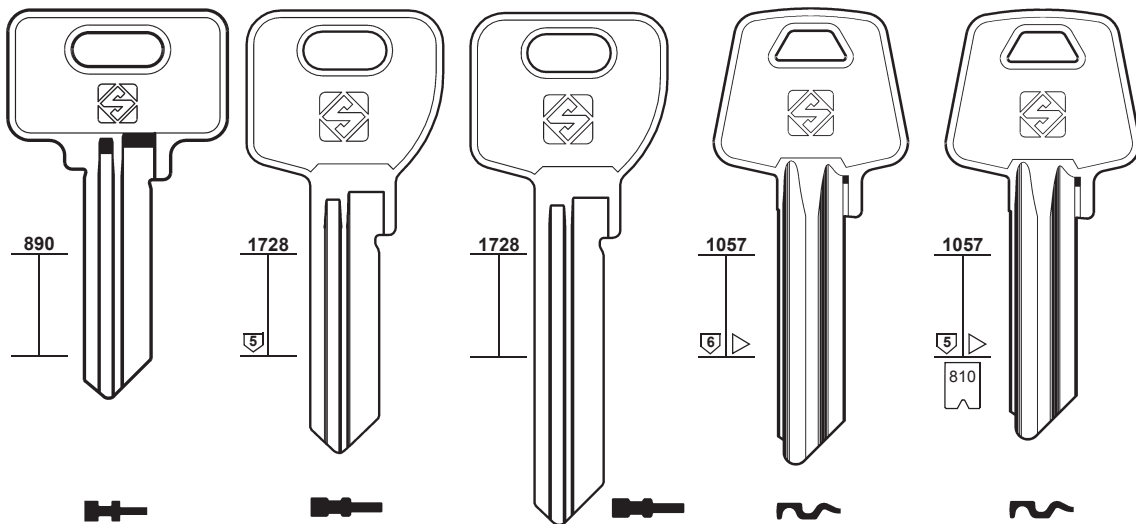

890

1728

1728

1057

1057

  
MC13

  
MC24

  
MC25

  
MC11  
X

  
MC12

E . . . . . 11241-79868  
X . . . . . 123456789

PER:  
FOR:

## MCM

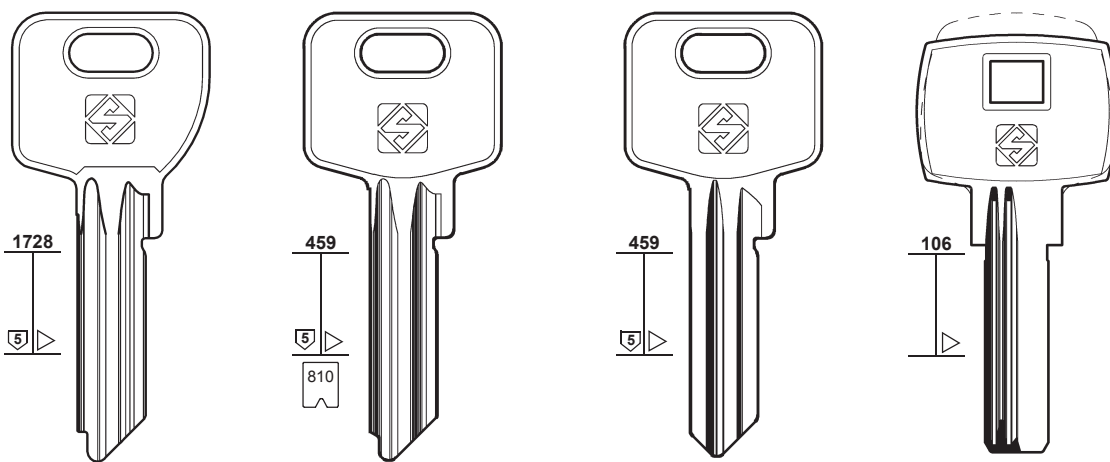

1728

459

459

106

  
MC21

  
MC20  
X . . . . . 1234567890  
E . . . . . 11241-79868

  
MC18R  
B  
  
MC19R  
C

  
MC14R



PER:  
FOR:

## MCM

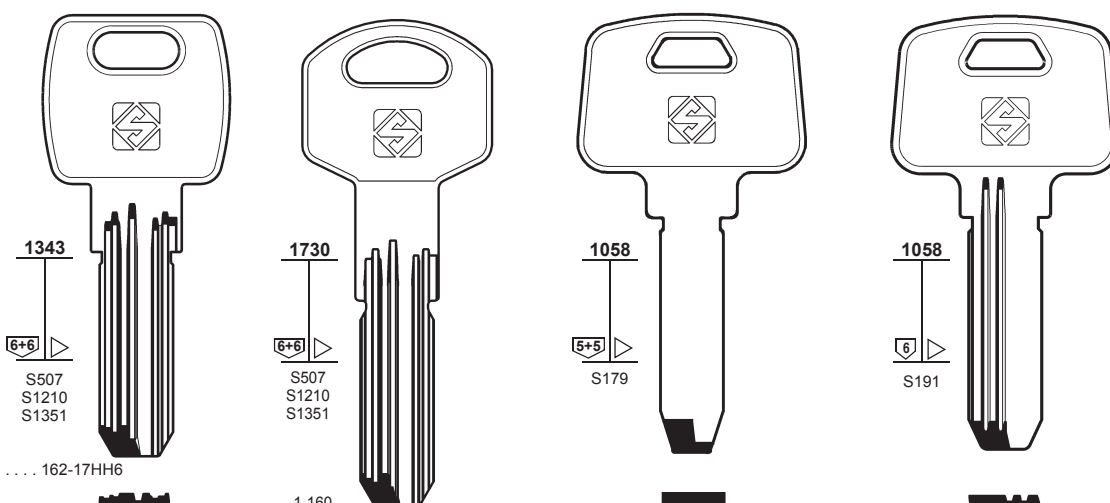

1343

1730

1058

1058

  
S507  
S1210  
S1351

  
S507  
S1210  
S1351

  
S179

  
S191

. . . . . 162-17HH6

  
MC15R  
E8

. . . . . 1-160  
. . . . . 012345678

  
MC26R

  
MC9X  
4SS

  
MC10R  
4SE



LOB - YETI



TROMER



PER: **MECO**  
FOR:

### MEDECO

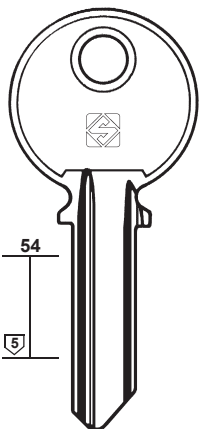

5



**MEC1**

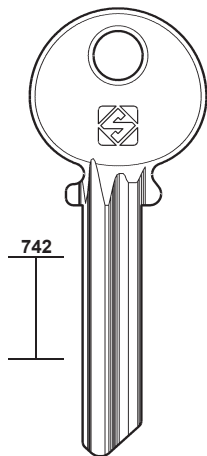

742



**MD4**

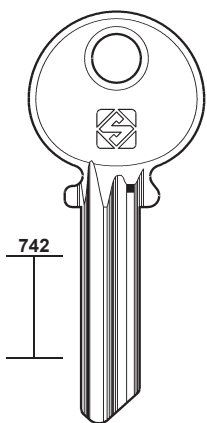

742



**MD7**

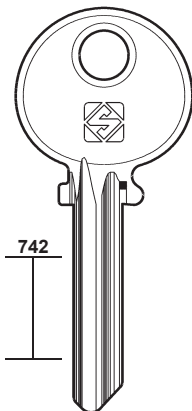

742



**MD6**

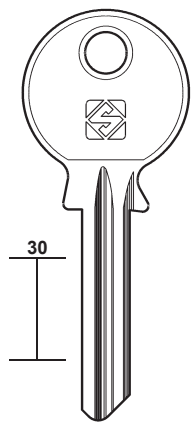

30



**MD1R**



**MD11**



**MD8R**



# 135

PER / FOR

**MECO** (DE)

**MEDECO** (US)

**ME-FA** (TW)  
BRABANTIA  
CLAUSOR

**MEGA** (RO)

**MELSMETALL** (DE)  
BURG  
HBC

PER:  
FOR:

### ME-FA

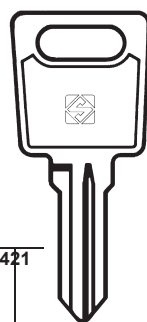

421

5

492



**MF1R**

... 1-100  
... 101-200

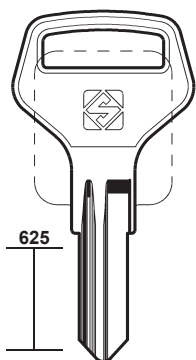

625



**MFA1**

BRABANTIA - CLAUSOR

### MEGA

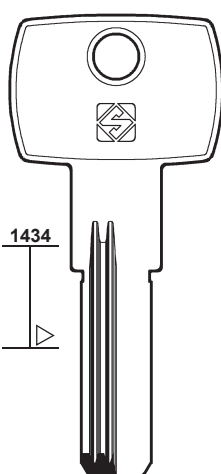

1434



**MEG1R**

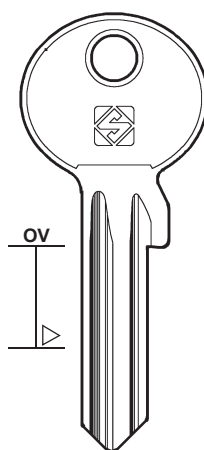

OV



**MEG2**



PER:  
FOR:

### MELSMETALL

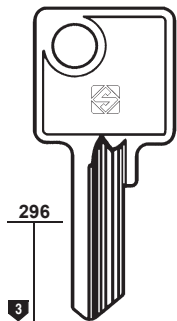

296

3



**ME2R**

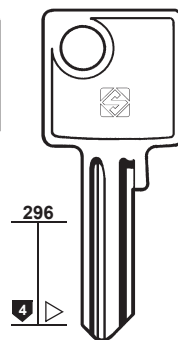

296

4



**ME8**

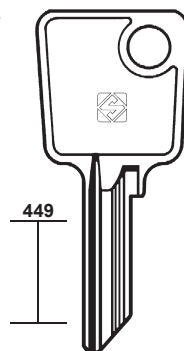

449



**ME1**

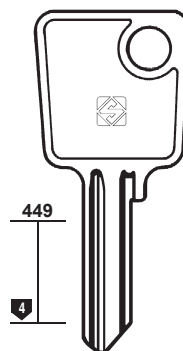

449

4



**ME3**



**ME6**

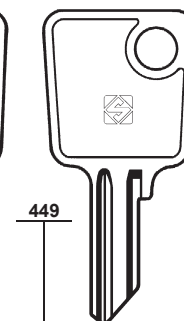

449



**ME7**



**ME4**



**ME4R**

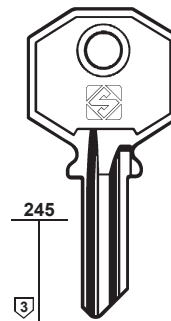

245

3



**BUR6**



**HBC**



**BURG**



# 136

### PER / FOR

#### MELSMETALL (DE)

BURG  
 FARCE  
 KEYA  
 SES  
 + BURG (42)

#### MENOVA (DE)

DOM (68)

#### MERCUR (DE)

JOWIL (110)

#### MERLE (AR)

#### MERMIER (FR)

CORBIN (59-60)

#### MERONI (IT)

BIB  
 CAROLI  
 LAMA  
 NOVOTECNICA  
 + CAS-CISMA (45)  
 + EVERGOOD (80)

PER:  
FOR:

## MELSMETALL

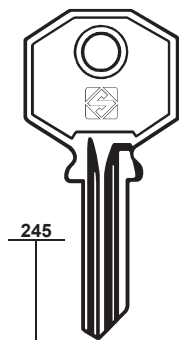

245



BUR2



BURG

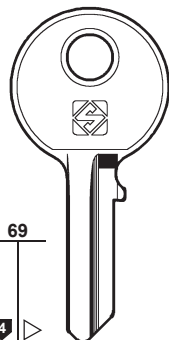

69



ME9

6 ... 1-30  
 6 ... 31-60  
 ..... 1234



FARCE  
KEYA - SES

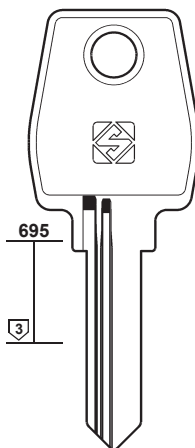

695



ME10R

## MERLE

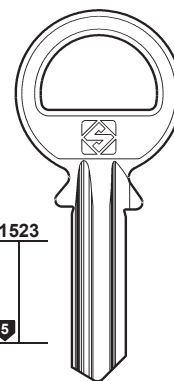

1523



MLE1

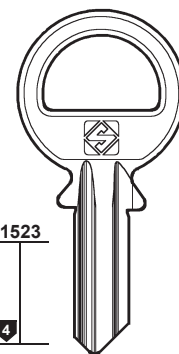

1523



MLE2

PER:  
FOR:

## MERONI

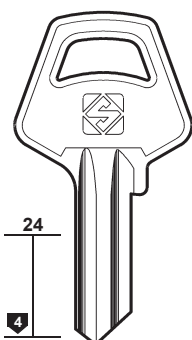

24



MER1

... 1001-1500

BIB - NOVOTECNICA



MER1R



LAMA

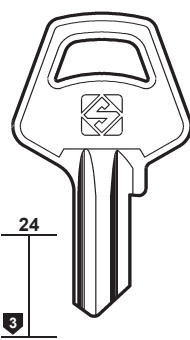

24



MER27

... T001-113  
 ... 1701-1810

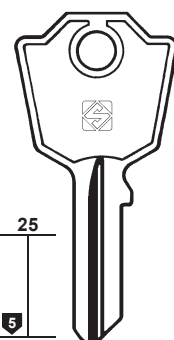

25



MER4

G ... 3001-3480  
 G ... 0-479  
 ... 3001-3480



MER4R



LAMA

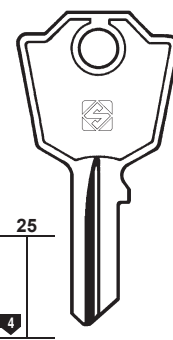

25



MER5



MER5R

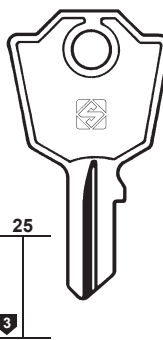

25



MER6



MER6R



PER:  
FOR:

## MERONI

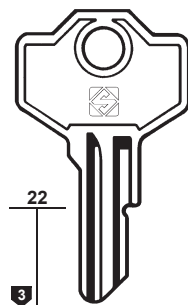

22



MER7R

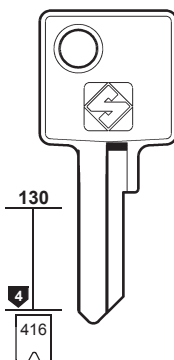

130



MER2

... 1-294  
 ... 301-400  
 ... 401-694  
 ... 941-975



CAROLI

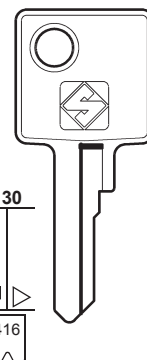

130



MER24

... 1-294

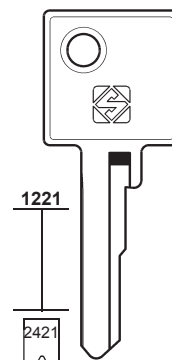

1221



MER29

... 1-294  
 ... 301-400  
 ... 401-694  
 ... 941-975



PER:  
FOR:

# MERONI

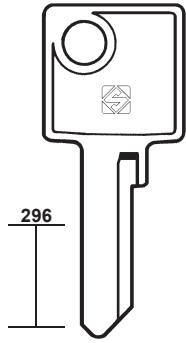

**MER23**  
PREMI-APRI

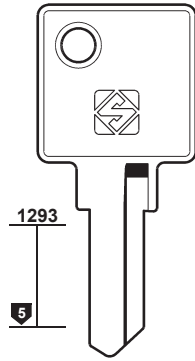

**MER31**

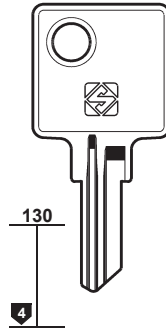

**MER32**



# 137

PER / FOR

**MERONI (IT)**  
EBA  
IJ  
JTF  
MING-TAY  
WINFOR  
+ CAS-CISMA (45)  
+ EVERGOOD (80)

PER:  
FOR:

# MERONI

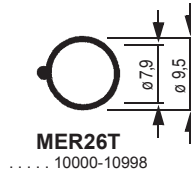
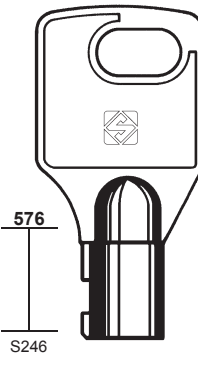
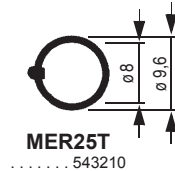
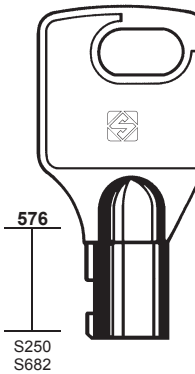
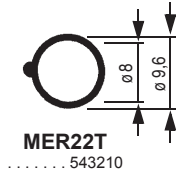
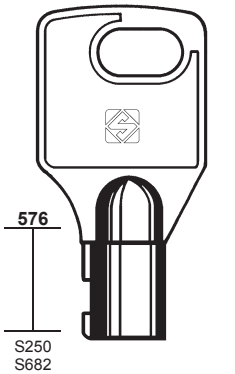

MING-TAY - WINFOR

PER:  
FOR:

# MERONI

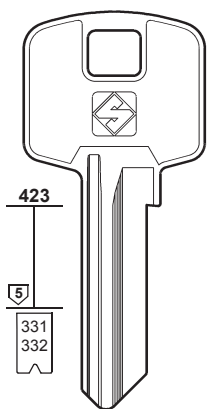

**MER8**  
..... T  
0-1-2-3-4-5-6-7-8-9  
M .....  
0-1-2-3-4-5-6-7-8-9  
  
PREMI-APRI  
EBA - IJ - JTF

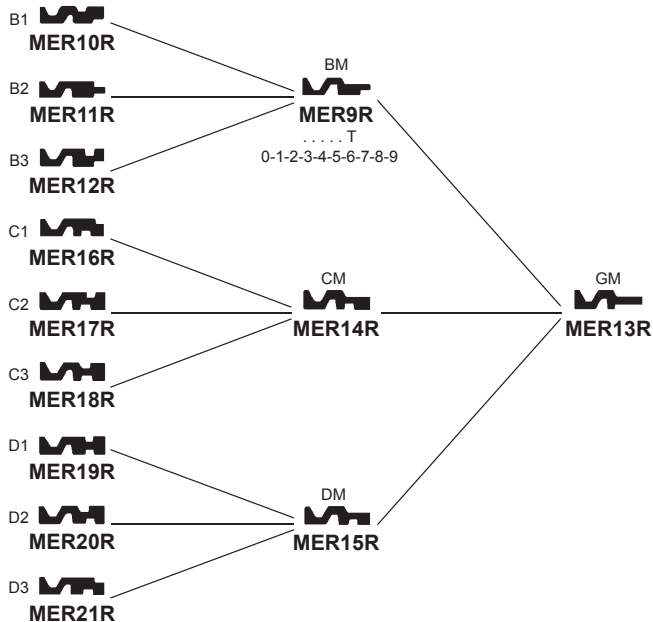



# 138

### PER / FOR

#### MERONI (IT)

- + CAS-CISMA (45)
- + EVERGOOD (80)

#### METAL (BG)

- + OJMAR (147)

#### METALCASTELLI (IT)

- + GIUSSANI (96)
- + HEKNA (102)
- + PREFER (157)

#### METALUX (FR)

- + TESA (181)
- + VACHETTE (199)

PER:  
FOR:

## MERONI

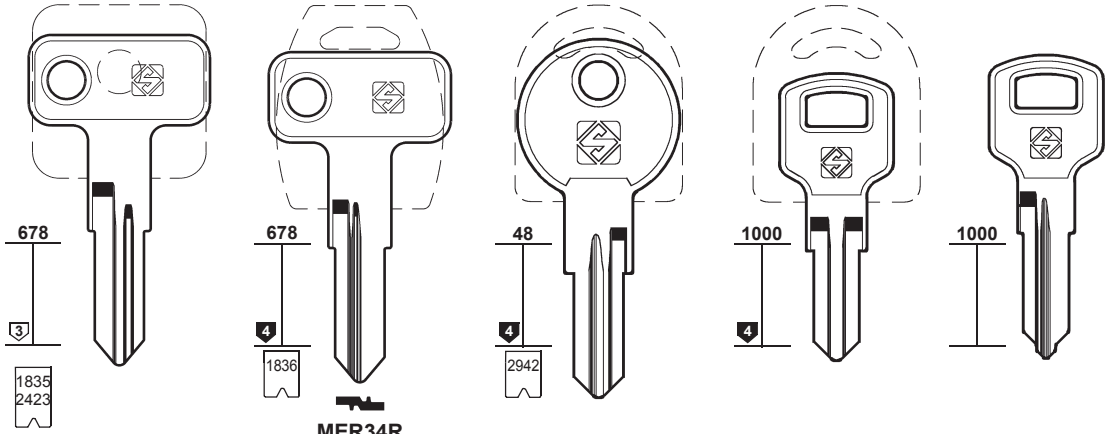

**MER33R**

... 0-1-2-3  
... 1-709  
CB ... 1-709

**MER34R**

CC ... 4001-4650

**MER35R**

CD

**MER36**

..... 1234

**MER37**

**MER42R**



PER:  
FOR:

## MERONI

## METAL

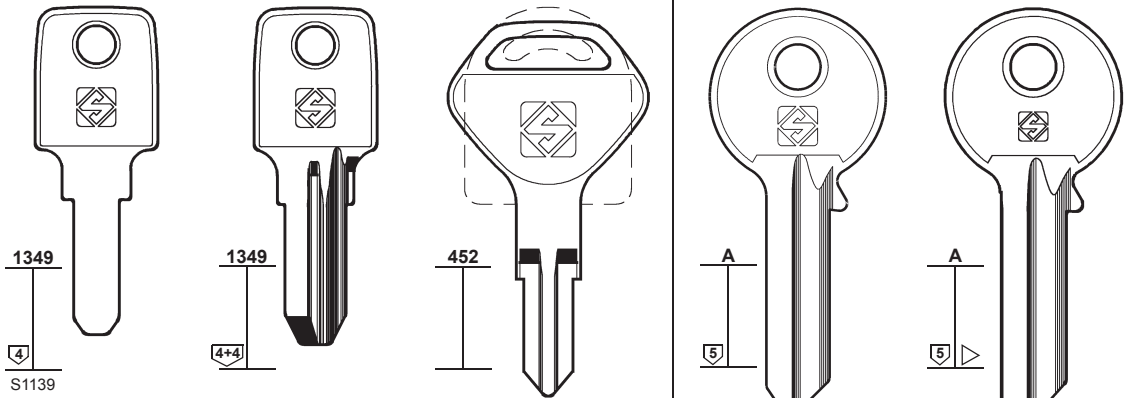

**MER39**

WA .....

**MER38**

**MER41**

**MTA1R**

**MTA3R**



PER:  
FOR:

## METAL

## METALUX

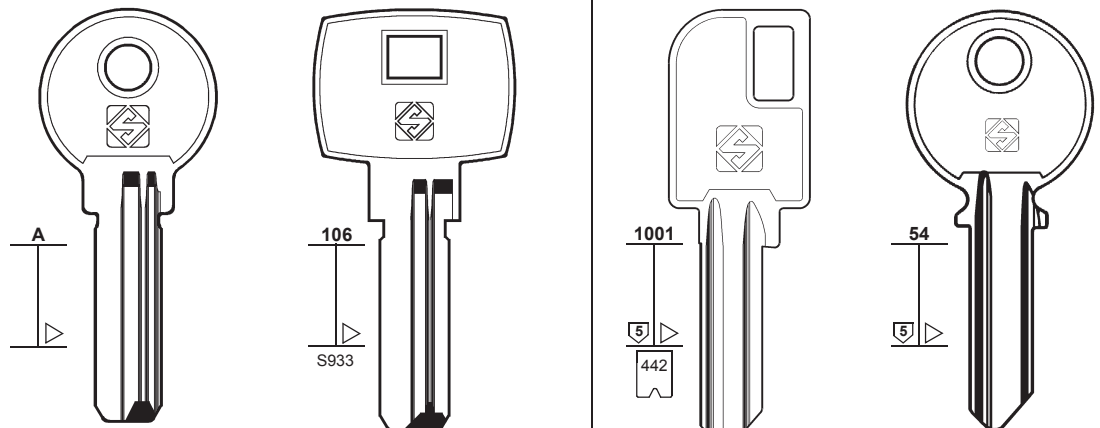

**MTA4**

**MTA2**

**MX1**

**MX5**



..... 1001-2178  
L ..... 1001-2178  
..... 1234567  
L ..... 14001-14500  
L ..... 15001-18199  
..... 20001-20625

PER: METEOR  
FOR:

MG (MONTI)



139

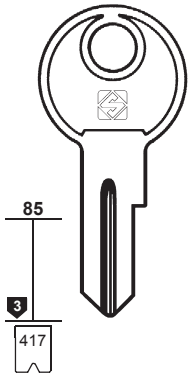

**MET1**  
B ... 1-600  
G ... 1-600

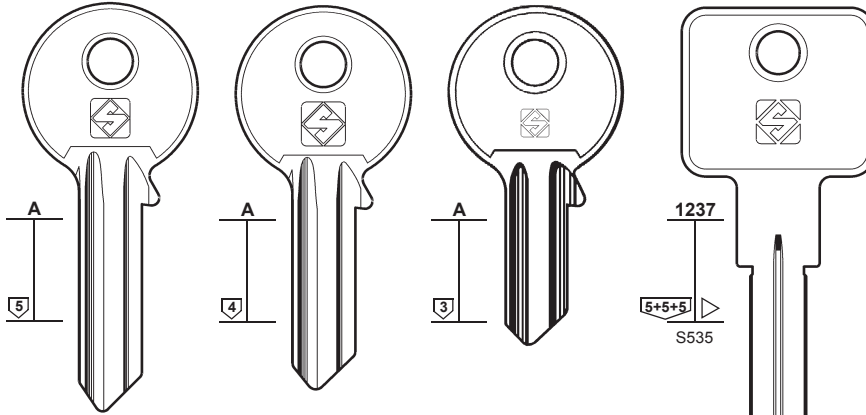

**MG1** **MG1R** **MG2** **MG2R** **MG3** **MG3R**

001001-163000

**MG8**  
PBA

PER: MG (MONTI)  
FOR:

MICHEL-SEAT

PER / FOR

**METEOR (FR)**  
+ BKS (35)  
+ DOM (68)  
+ KIFERM (117)

**METIZ (UA)**  
+ KIEV (117)

**MG (MONTI) (IT)**

**MIAN-FORCE (TW)**  
+ GLOBE (97)

**MIBRA (GB)**  
+ L & F (128)

**MICHEL-SEAT (IT)**  
O.M.R.  
POTENT  
+ O.M.R. (149)  
+ POTENT (156)  
+ SEAT (167)

**MILA (DK)**  
+ EVO (80)

**MILANO (BR)**

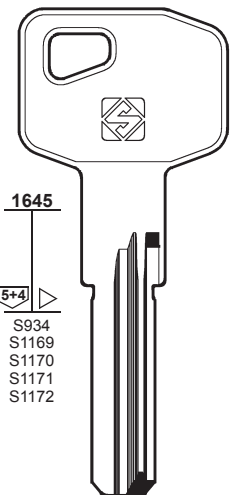

S934  
S1169  
S1170  
S1171  
S1172

A5 ... 00010-28000  
A6 ... 00010-28000  
A7 ... 00010-28000  
A8 ... 00010-28000

**MG9**  
X8

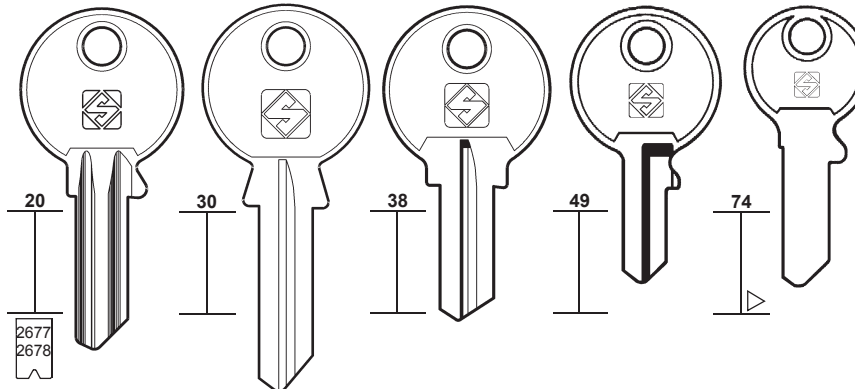

**MH1**  
... 201-436

**MH2**

**MH4**

**SEA4**

**MH3**

**MH1R**  
... 437-672

**MH2R**

**MH4R**

**SEA4R**



POTENT  
O.M.R.



POTENT

PER: MICHEL-SEAT  
FOR:

MILA

MILANO

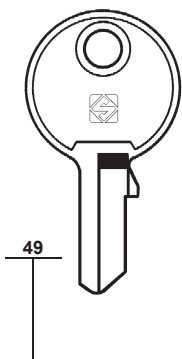

**MH5**

**MH5R**

**POTENT**

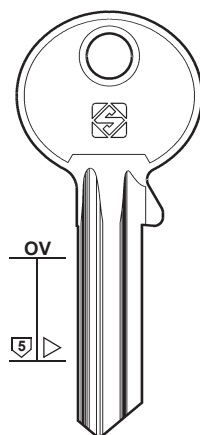

**MIL1**

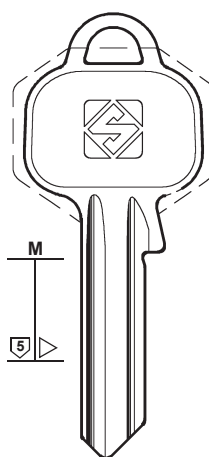

**MIL2**

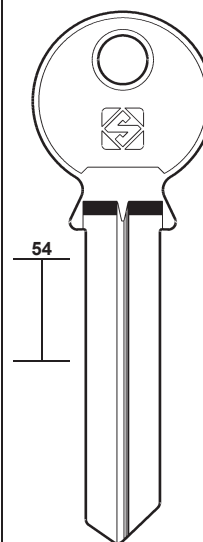

**MLN3**

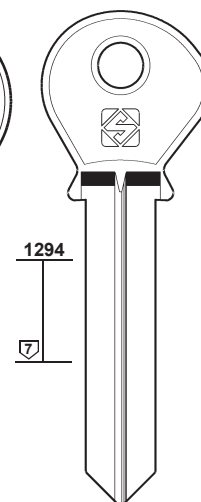

**MLN1**



# 140

PER / FOR

**MILES** (RU)

**MING-TAY** (TW)

SOS  
+ MERONI (137)

**MIPPART** (DE)

DOM (70)

**MIT** (IT)

INDESIT (107)

**MIWA** (JP)

NITI LOCKS

PER: FOR:		MILES	MING-TAY
 1578 12 MIS1	 1578 12 MIS2	 N MTY1	 N MTY2
		 SOS	

PER: FOR:		MIWA				
 131 MIW1	 1028 774 MIW2 ..... 1-2-3-4	 1105 775 3545 MIW3 ..... 0-1-2-3-4	 1446 MIW14	 1446 1542 3649 MIW15 ..... 0-1-2-3-4-5		
NITI LOCKS						

PER: FOR:		MIWA				
 1106 792 3551 3650 MIW13 ..... 1234 ..... 01234	 1106 787 MIW4	 1107 778 3547 MIW5 ..... 1-2-3-4-5	 1111 789 3548 MIW6 ..... 0-1-2-3-4	 1028 790 3549 MIW7 ..... 1-2-3-4		

PER:  
FOR:

**MLM**

**MLP**

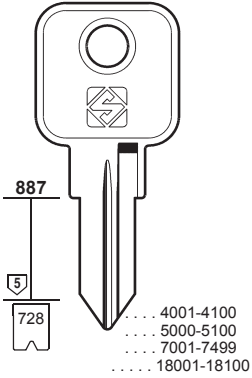

**MLM1**

**MLM1R**

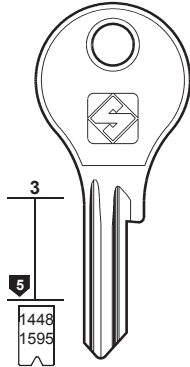

**MLM2** L... 1-101  
L... 1-222

**MLM3R** **MLM6R**  
**MLM4R** **MLM7R**

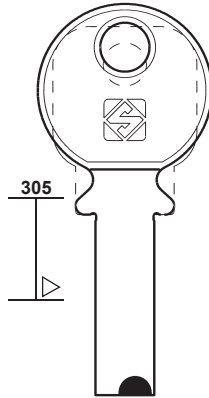

**MLM5**

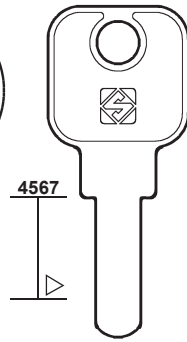

**MLM15**

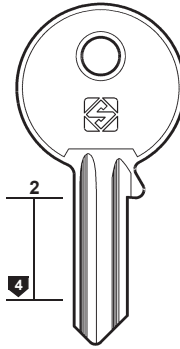

**GS2** **GS2R**

**GIUSSANI**

DOM - LEHMANN - ORDO - STUV



**141**

PER / FOR

- MLM (DE)**
- DOM
- LEHMANN
- ORDO
- STUV
- + DOM (68-70)
- + LEHMANN (122)
- + OJMAR (147)
- + RONIS (161)

- MLP (IT)**
- GIUSSANI
- + GIUSSANI (96)

**MOBELLA (SE)**

- MODA (FR)**
- PICARDIE (155)

**MODERN (TW)**

- MODERN BAU (DE)**
- VACHETTE (199)

- MOFLEX (ES)**
- OJMAR (147)

**MOIA (IT)**

**MON (ES)**

- MONACOR (TW)**
- ALPHA (16)

- MONDIAL (FR)**
- G.R. (99)
- RONIS (161)

- MONDRAGON (ES)**
- MCM (133)

- MONOBLOC (FR)**
- FO
- + ZENITH (222)

**MONTI-MG (IT)**

PER:  
FOR: **MOBELLA**

**MODERN**

**MOIA**

**MON**

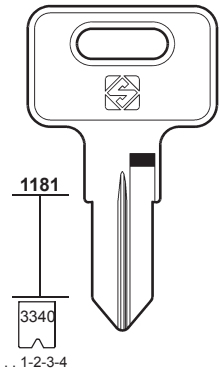

**MBL1**

**MBL1R**

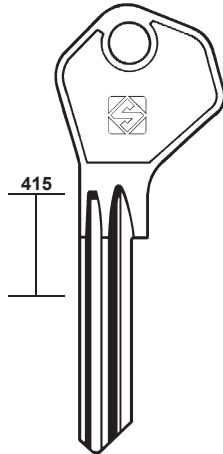

**MOD1**

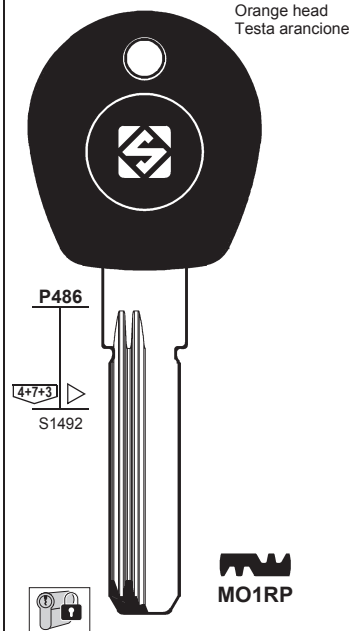

Orange head  
Testa arancione

**MO1RP**

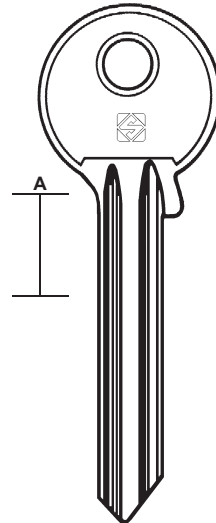

**MON1** **MON1R**

PER:  
FOR: **MONOBLOC**

**MONTI-MG**

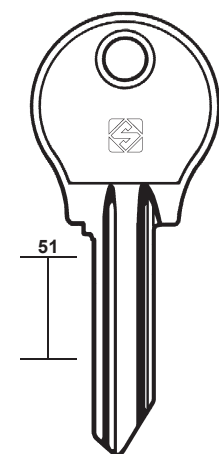

**MB1**  
FO

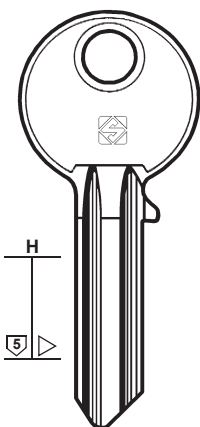

**MN9** **MN9R**

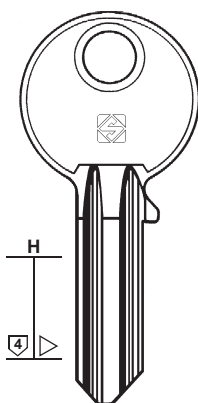

**MN8** **MN8R**

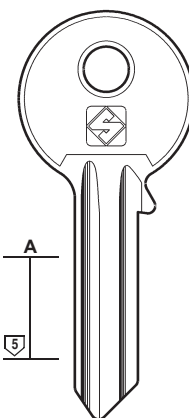

**MN1** **MN2** **MN2R**

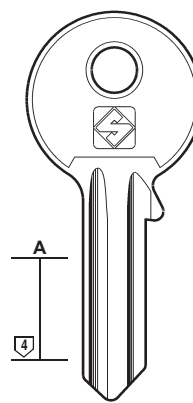

**MN7** **MN7R** **MN3** **MN3R**



# 142

PER / FOR

**MONTI-MG** (IT)

**MOREAUX** (FR)

👁️ DOM (71)

👁️ RONIS (161)

👁️ WALLY (207)

**MORI E.** (IT)

CRISTIANI

FEB

LML

LR

TAMPALINI

ZANI

+ 👁️ FIAM (88)

**MORI G.** (IT)

**MOSCON** (RU)

**MOSRENTGEN** (RU)

**MOTORSICH** (UA)

PER:  
FOR:

## MONTI-MG

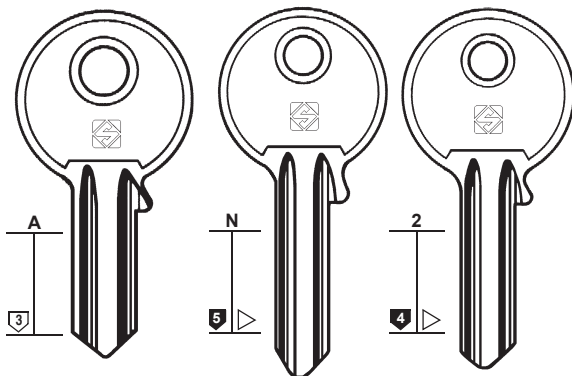

MN4



MN5



MN6



MN4R



MN5R



MN6R

## MORI E.

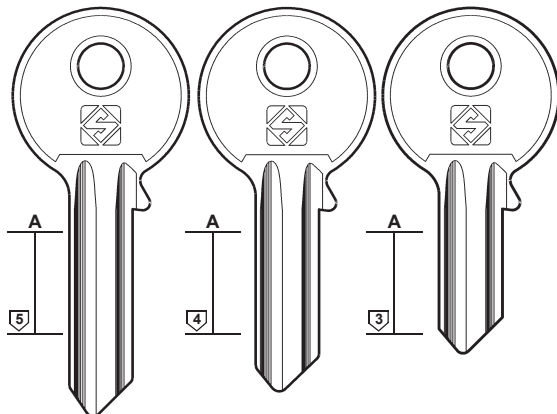

MI1



MI2



MI5



MI1R



MI2R



MI5R

CRISTIANI - LML - LR - TAMPALINI - ZANI

PER:  
FOR:

## MORI E.

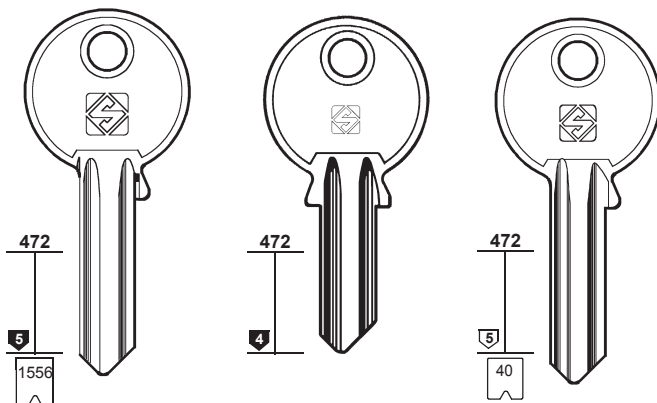

MI3



MI7



MI8



MI3R



MI7R

FEB

..... 1-2-3-4-5-6

G... 1-78

## MORI G.

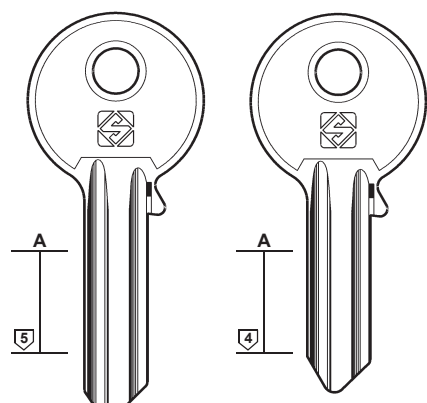

MIG1



MIG2



MIG1R



MIG2R

PER:  
FOR:

## MOSCON

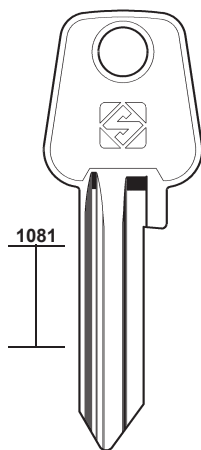

MSC1

## MOSRENTGEN

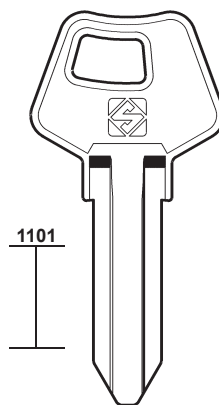

MST1

## MOTORSICH

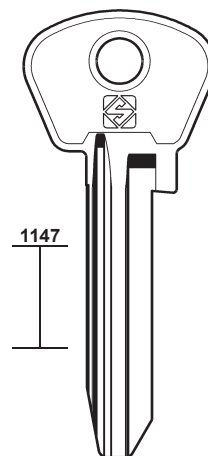

MTS1



MTS1R



PER:  
FOR:

### MOTTA

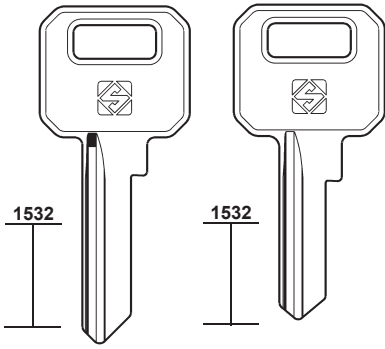

MTT1R

MTT2R

### MP-PLODARI

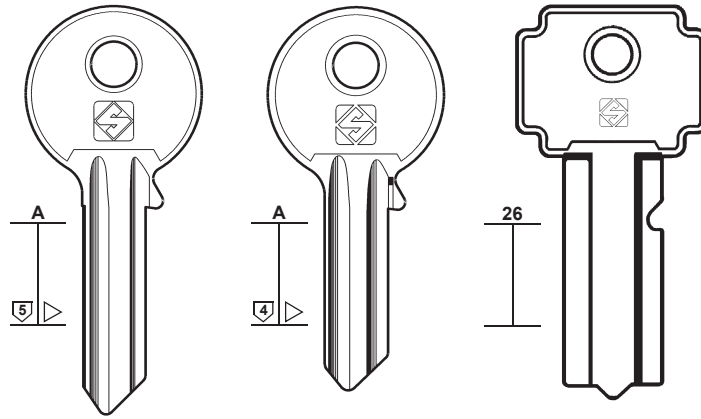

MP230

MP231

MP228

MP229

MP101



# 143

PER / FOR

MOTTA (BR)

MOTTURA (IT)  
GEVY (95)

MP-PLODARI (IT)

MSM (CN)  
CINA (54)

M.S.S. (PT)

MST (IT)  
CAS-CISMA (45)

MSV (PT)

MUKRA (DE)  
CORBIN (60)

MULT-LEI (GR)

MULT (BR)

MUL.T.LOCK (IL)  
CORNI (62)

PER:  
FOR:

### MP-PLODARI

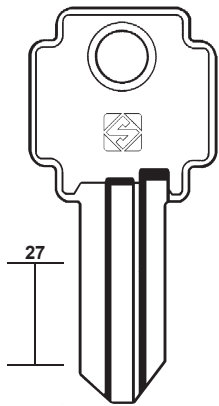

MP102

MP103

MP104

MP105

### M.S.S.

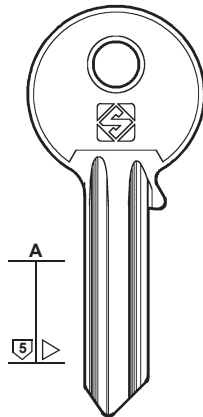

MSF1

### MSV

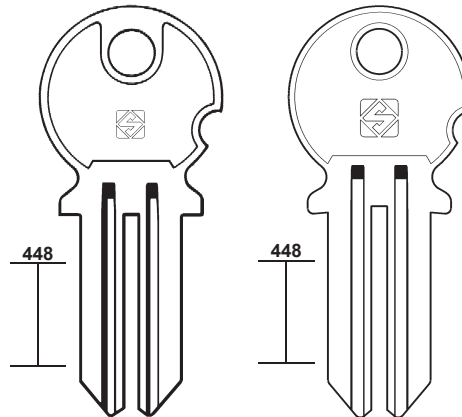

MSV1

MSV2

MSV1R

MSV2R

PER:  
FOR:

### MULT-LEI

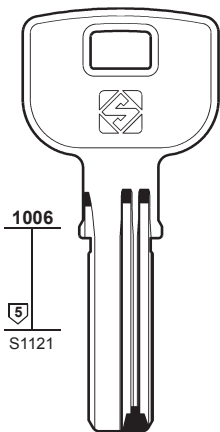

MTL1



### MULT

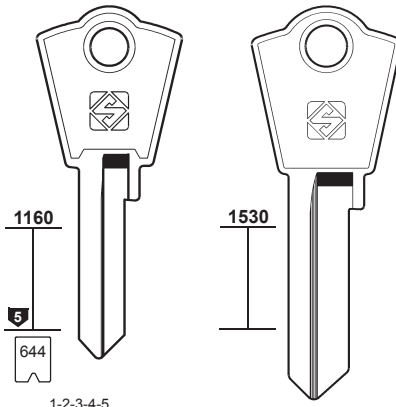

MUL1

MUL2

### MUL.T.LOCK

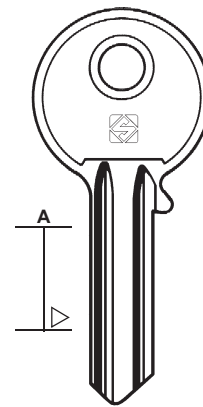

MTK5

MTK5R



# 144

PER / FOR

**MUL.T.LOCK (IL)**  
GARRISON  
SP

+ CORNI (62)

PER:  
FOR:

## MUL.T.LOCK

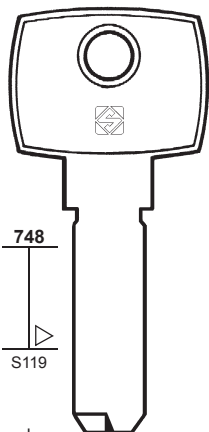

748  
S119

J...  
9001-9766

**MTK1**

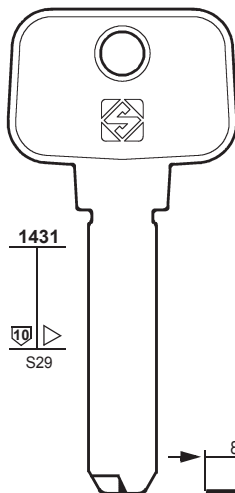

1431  
S29

8.8

**MTK2**  
(006)  
ABCD-12345

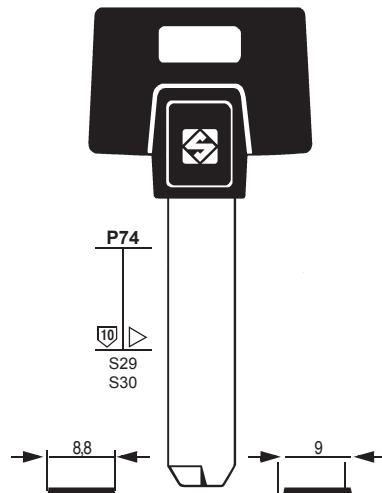

P74  
S29  
S30

8.8

**MTK2P**  
(006)  
ABCD-12345

9

**MTK3P**  
(006)  
ABCD-12345-01



PER:  
FOR:

## MUL.T.LOCK

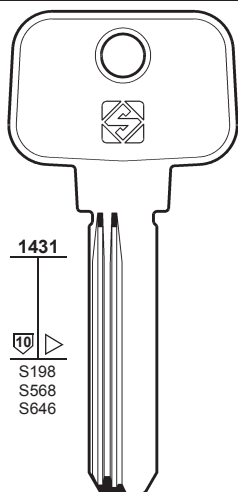

1431  
S198  
S568  
S646

**MTK11R**



GARRISON

05   
**MTK11**  
(005)  
ABCD-12345

11   
**MTK16**

**MTK10R**  
(006)  
ABCD-12345-01

66   
**MTK15R**

64   
**MTK8R**  
(006)  
ABCD-12345-01

77   
**MTK13R**

50   
**MTK7R**  
(006)  
ABCD-12345-01

08   
**MTK12R**  
(008)  
ABCD-12345

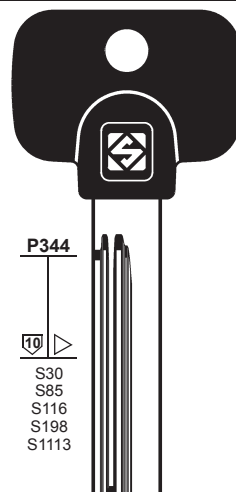

P344  
S30  
S85  
S116  
S198  
S1113

**MTK10RP**  
(006)  
ABCD-12345-01



SP

**MTK9RP**

64   
**MTK8RP**  
(006)  
ABCD-12345-01

50   
**MTK7RP**  
(006)  
ABCD-12345-01

05   
**MTK4P**  
(005)  
ABCD-12345

06   
**MTK4RP**  
(006)  
ABCD-12345-01

PER:  
FOR:

## MUL.T.LOCK

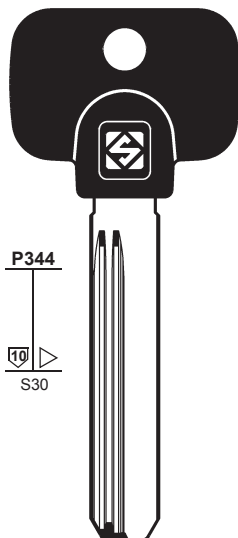

P344  
S30

**MTK4RPX**

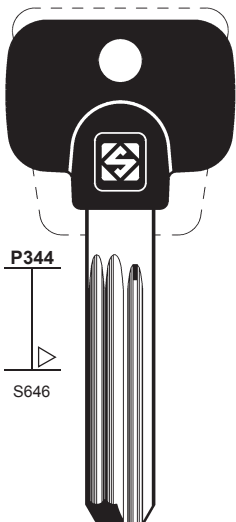

P344  
S646

**MTK12RP**  
(008)  
ABCD-12345

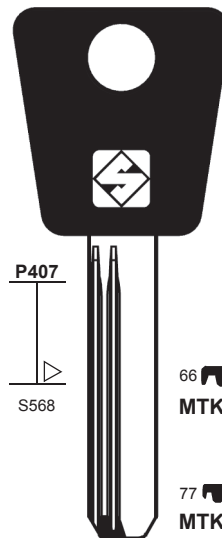

P407  
S568

66   
**MTK15RAP**

77   
**MTK13RAP**

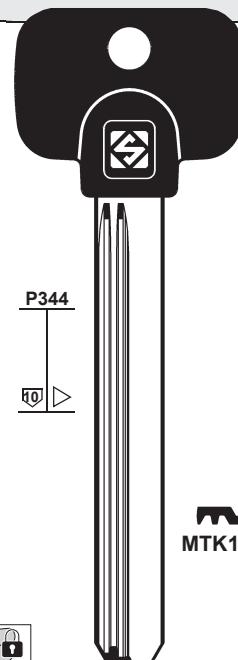

P344

**MTK14RP**



GARRISON

PER:  
FOR:

### NABOB

### NAIKI

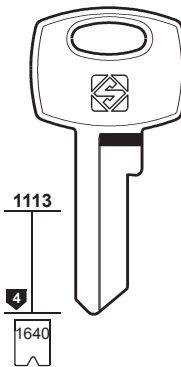
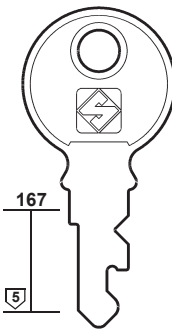
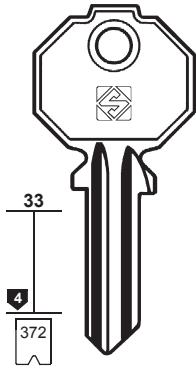
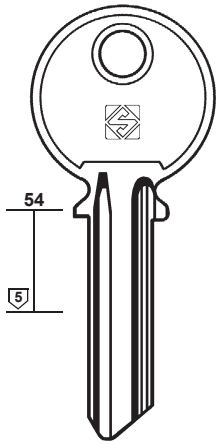
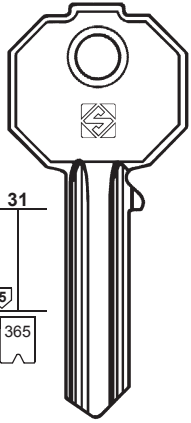

0-1-2-3-4-5-6-7-8

0-1-2-3-4-5-6



# 145

PER / FOR

NABOB (IL)

NAIKI (JP)

NATIONAL CABINET (US)  
NATIONAL CASH REGISTER  
NATIONAL ROCKFORD

NATIONAL CASH REGISTER (US)  
NATIONAL CABINET (145)

NATIONAL LOCK HARDWARE (US)  
NATIONAL ROCKFORD (145)

NATIONAL ROCKFORD (US)  
NATIONAL LOCK HARDWARE  
+ NATIONAL CABINET (145)

NAZABAL (ES)  
EZCURRA (82)

NB (DE)  
CISA (55)  
FLORA (90)

NEC (JP)

NELFA (DK)

PER:  
FOR:

### NATIONAL CABINET

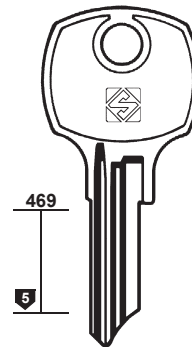
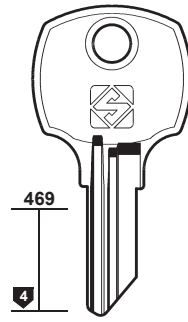
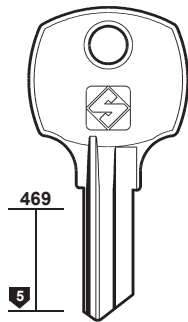
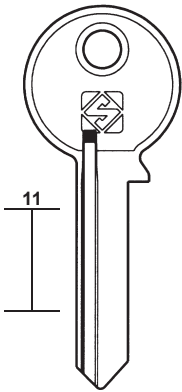

NATIONAL CASH REGISTER

NATIONAL ROCKFORD



PER:  
FOR:

### NATIONAL ROCKFORD

### NEC

### NELFA

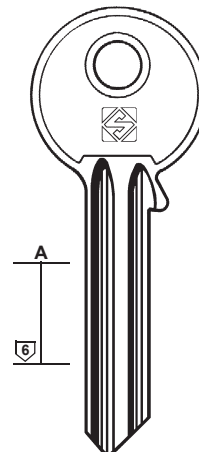
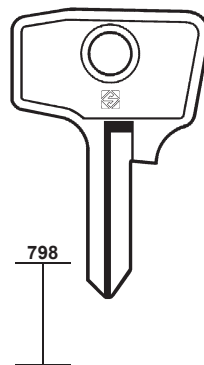
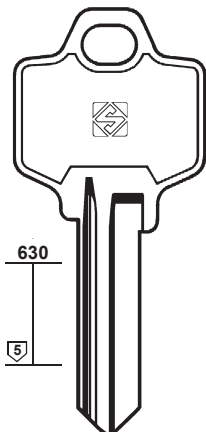
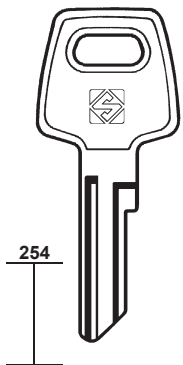

NATIONAL LOCK HARDWARE





# 146

### PER / FOR

#### NEMEF (NL)

- + CES (47-48)
- + CORBIN (60)
- + RONIS (161)

#### NEPTUNE (GB)

#### NICO (DE)

- + FTH (91)
- + KVV (116)

#### NINO (ES)

- + TESA (181)

#### NITI LOCKS (JP)

- + MIWA (140)

#### NOBO (NO)

- + DOM (69-71)
- + VING (205)

#### NONES (IT)

#### NONFANGO (IT)

#### NORDWEST (DE)

- + FLORA (90)
- + SCHLECHTENDAHL (166)

#### NOVA (DE)

- + TOP (187)
- + YETI (219)

#### NOVOFERM (IT)

- + CORBIN (60)

#### NOVOTECNICA (IT)

- + MERONI (136)

#### NUMIDIA (ES)

- + ESA (77)
- + RONIS (161)

#### OAL (IT)

- + CORBIN
- + CORBIN (59)
- + GIUSSANI (96)

#### OB (IT)

- + ZANETTI A. (220)

#### OBEL-ODARIA (JP)

#### ODA (NL)

- + ANKERSLOT (17)
- + CHICAGO (51)

PER: FOR:	NEMEF	NEPTUNE	NONES
	 1627  OV  5	 625  5	 155  5
	 <b>NME4R</b> NF3  <b>NME1R</b> NF2  <b>NME2R</b> NF1  <b>NME3</b>	 <b>NP1R</b> 	 <b>NN1</b> 

PER: FOR:	NONFANGO	OAL
	 33  20  4	 14  15  5 312 313  5 314 315 316 2612
	 <b>PF12</b>  <b>PT1</b>  <b>PT1R</b>	 <b>CB1</b> ..... 2-3-4-5-6-7-8-9 ..... 1-2-3-4-5-6-7-8-9  <b>CB1R</b> ..... 1-2-3-4-5-6-7-8-9  <b>CB3</b> ..... 1-2-3-4-5-6-7-8-9 ..... 2-3-4-5-6-7 ..... 1-2-3-4-5-6-7-8
		 <b>CORBIN</b>

PER: FOR:	OAL	OBEL-ODARIA
	 54  11  11  34  5  4  3	 N  5  3
	 <b>OAL4</b>  <b>OAL4R</b>  <b>OAL3</b>  <b>OAL3R</b>  <b>OAL2</b>  <b>OAL2R</b>	 <b>OB1</b>  <b>OAL1</b>  <b>OAL1R</b>

PER: OFFERMANS-FLOOD  
FOR:

OJMAR

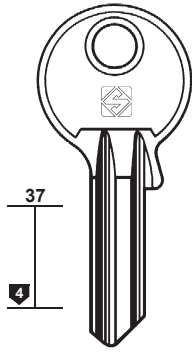

OF4

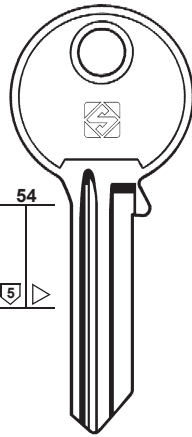

OJ2

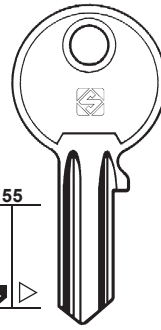

OJ1



OJ1R

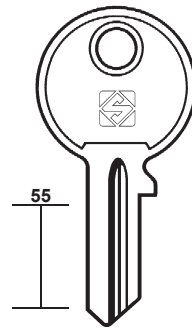

OJ3R



147

PER / FOR

OFFERMANS-FLOOD (CL)

OJMAR (ES)

BURG  
METAL  
MLM  
MOFLEX  
SISO  
STUMPF

+ CES (47)  
+ HR (103)

PER:  
FOR:

OJMAR

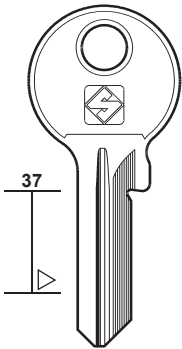

OJ16R

J

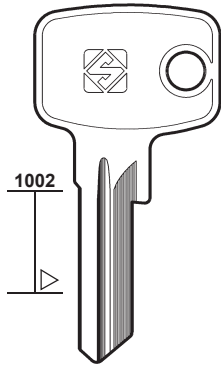

OJ5R

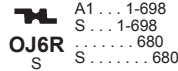
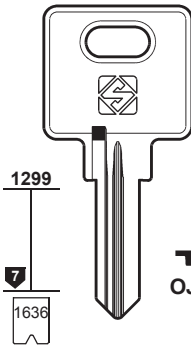

OJ6R

S

A1 ... 1-698  
S ... 1-698  
S ... 680  
S ... 680



OJ7R

A ... 1-698  
S ... 1-698  
U ... 1-698  
S ... 680



OJ8R

F ... 680



OJ9

F1



OJ10R

U ... 680



OJ11

BURG - METAL - MOFLEX  
SISO - STUMPF

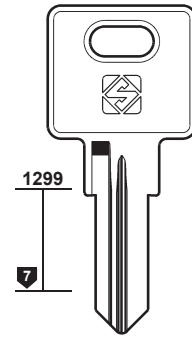

OJ12R OJ13R

Y Z

BURG - MLM

PER:  
FOR:

OJMAR

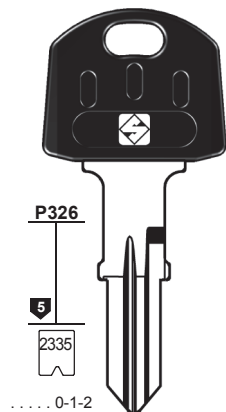

OJ15RP

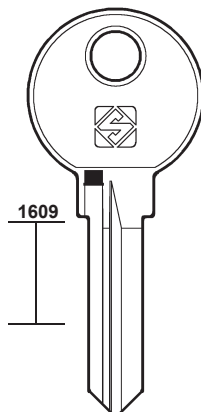

OJ17R

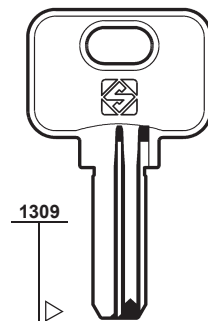

OJ14

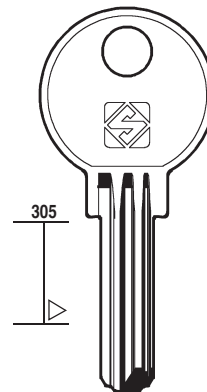

OJ18

5-Q4





# 148

PER / FOR

**OLIVA** (IT)  
FERMABLOCK  
PB  
PREFER

**OLIVETTI** (IT)  
CASIO  
+ GIOBERT (96)

**O.M.A.** (IT)  
C.A.R.S.

PER:  
FOR:

## OLIVA

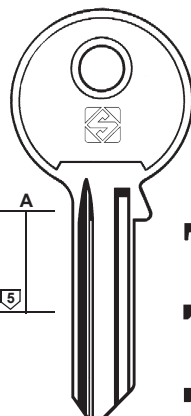
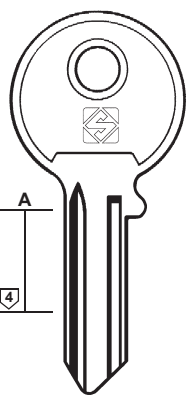



  
OL5

  
OL5R

  
OL4

  
OL4R

  
OL3

  
OL3R

  
OL1

  
OL1R

  
OL2

  
OL2R

  
OL6

  
OL6R

FERMABLOCK - PB - PREFER

## OLIVETTI

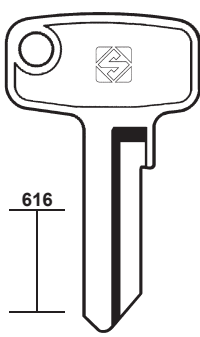
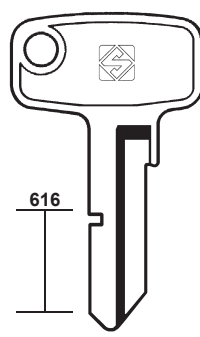
  
OLT1

  
OLT2



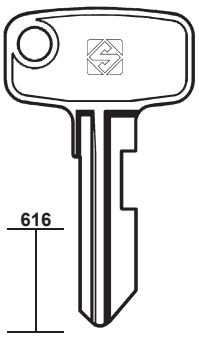
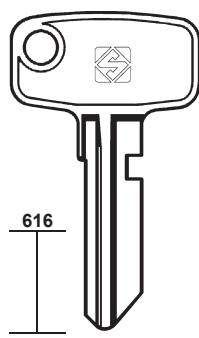
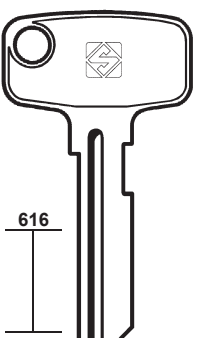
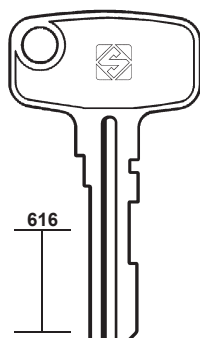

PER:  
FOR:

## OLIVETTI







  
OLT4

  
OLT5

  
OLT6R  
X

  
OLT8R  
P

 CASIO
  CASIO

PER:  
FOR:

## OLIVETTI

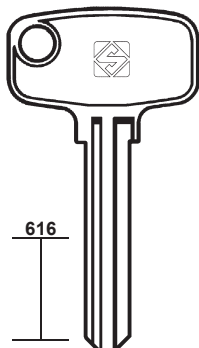
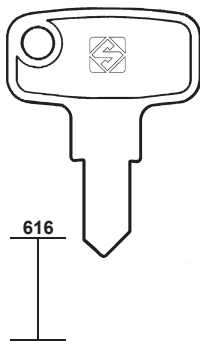
  
OLT7  
X

  
OLT3



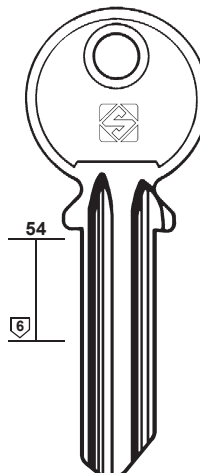
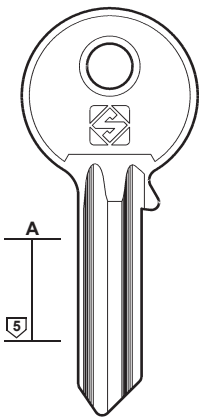
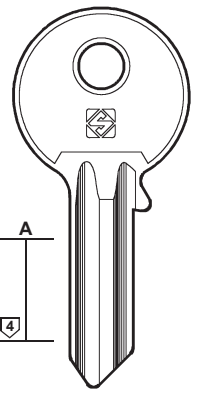

PER:  
FOR:

## OMA







  
OA1

  
OA1R

  
OA2

  
OA2R

  
OA3

  
OA3R

C.A.R.S.

C.A.R.S.

PER:  
FOR:

### OMEK

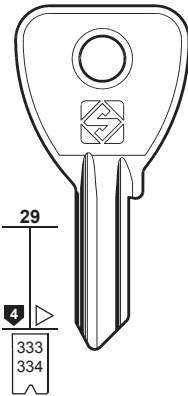
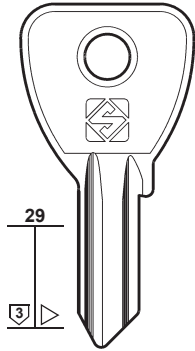
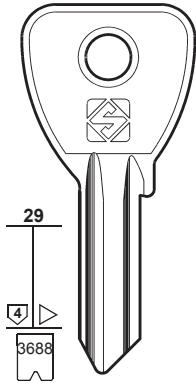
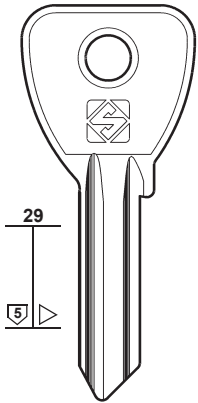
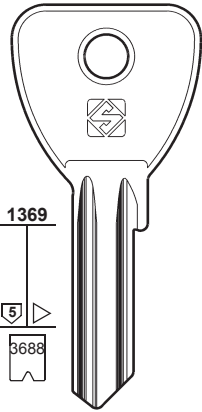

**OC5**  
.....  
123456789



**OC238**



**OC239**



**OC236**



**OC237**



**OC2**



**OC2R**



**OC1**



**OC1R**

.....  
12345



# 149

PER / FOR

**OMEK (IT)**  
SANTOS

**OMIV (IT)**

CIB  
STV  
+ BIELLE (33)

**O.M.R. (IT)**

MICHEL-SEAT  
+ HÄFELE (101)  
+ MICHEL-SEAT (139)  
+ POTENT (156)  
+ PREFER (157)

PER:  
FOR:

### OMEK

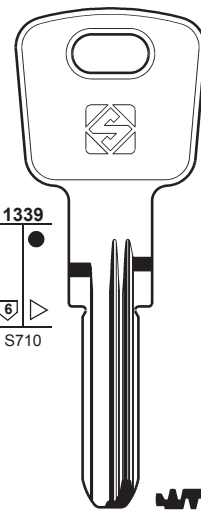
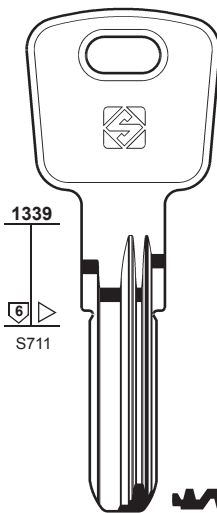
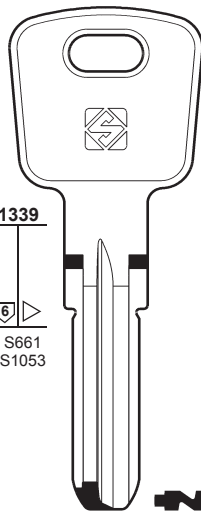
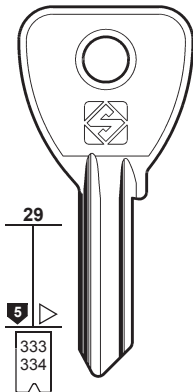

**OC074**



**OC075**

..... 1-2-3-4-5



**OC3**



**OC4**

AB .....  
0000001-0046656



SANTOS

BA .....  
0000001-0046656



**OC6**

PER:  
FOR:

### OMIV

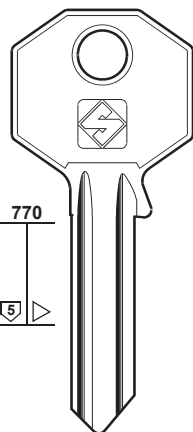
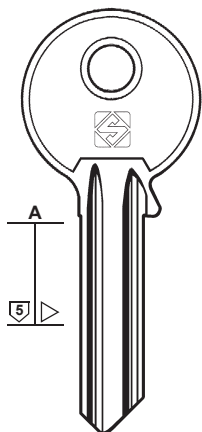
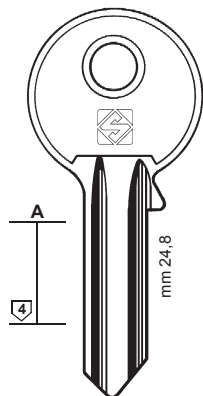

**OV1**



**OV1R**

CIB - STV



**OV2**



**OV2R**

CIB - STV



**OV3**



**OV3R**

### O.M.R.

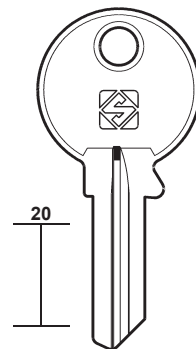
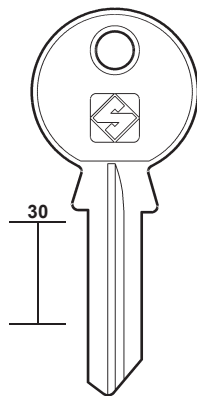

**MH2**



**MH2R**



**PT1**



**PT1R**

MICHEL-SEAT



# 150

### PER / FOR

**O.M.R.** (IT)  
MICHEL-SEAT  
+ HÄFELE (101)  
+ MICHEL-SEAT (139)  
+ POTENT (156)  
+ PREFER (157)

**ONIUN** (TWW)  
UNION (193)

**ORBA** (DE)  
SIMECA (170)

**ORDO** (FR)  
+ KIFERM (117)  
+ LAS (122)  
+ MLM (141)

**ORION NOVOX** (FR)  
DECAYEUX

**ORLANDO** (IT)  
ICSA (105)

**ORO** (IL)

**ORSA** (BY)

**OSKO** (DE)  
JOWIL (110)

**OT** (IT)  
FONDAR (90)

**OTHMER** (DE)  
ABUS (6)

**OTIS** (IT)  
+ CES (47)  
+ ILLINOIS (106)  
+ ZEISS-IKON (220-221)

**OTTO** (IT)  
BURG (43)

**PACRI** (BR)

PER:  
FOR:

## O.M.R.

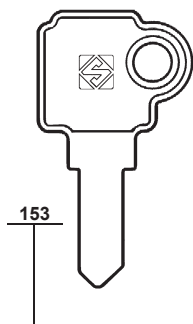

153

SEA5 SEA5R

SEA7 SEA8



MICHEL-SEAT

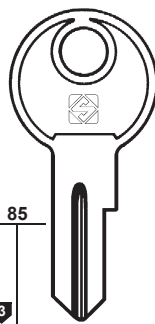

85

3

417

MET1

B... 1-600  
G... 1-600

MICHEL-SEAT

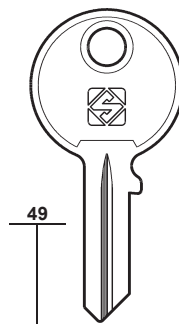

49

OMR1R



## ORDO

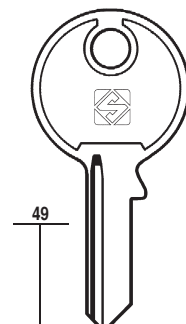

49

OR1R



PER:  
FOR:

## ORION NOVOX

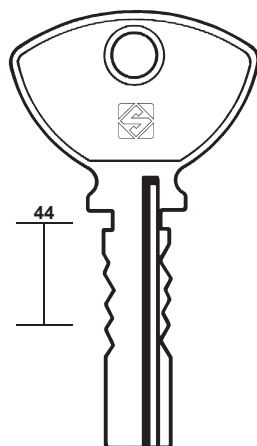

44

ON1 ON1R

DECAYEUX

## ORO

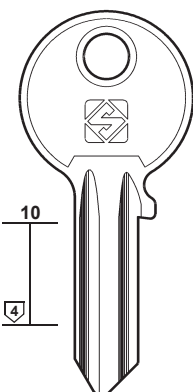

10

4

ORO1 ORO2

## ORSA

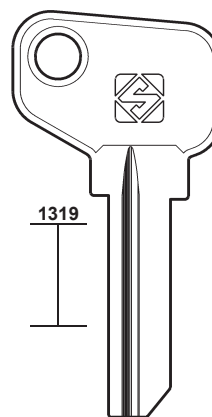

1319

ORA1

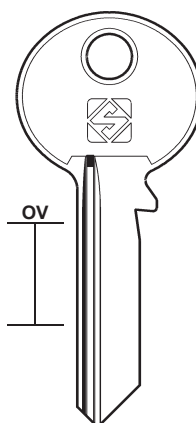

OV

ORA2

PER:  
FOR:

## PACRI

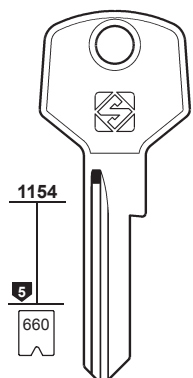

1154

5

660

..... 1-2-3-4-5-6-7

PAC1R

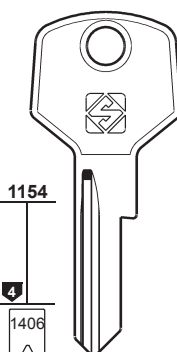

1154

4

1406

.... 1-2-3-4

PAC2R

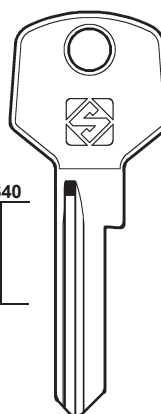

1640

PAC3R

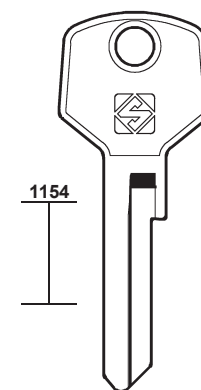

1154

PAC4



PER:  
FOR:

### PADO

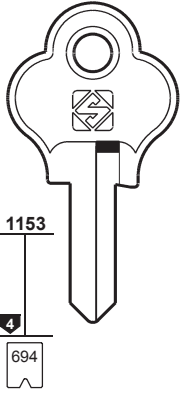

..... 1-2-3



PDO12



PDO12R

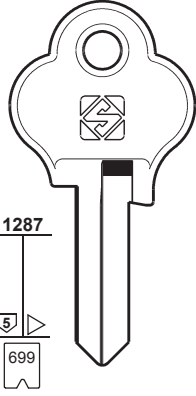

..... 1-2-3-4-5



PDO17



PDO17R

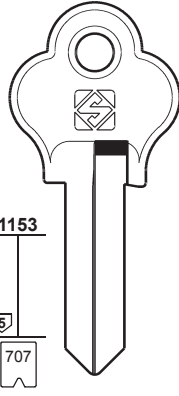

..... 1-2-3-4-5-6



PDO2

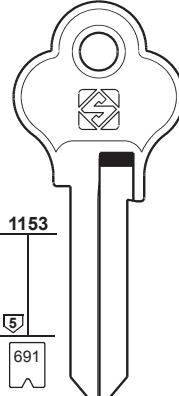

..... 1-2-3-4-5



PDO9



PDO9R



# 151

PER / FOR

PADO (BR)

PER:  
FOR:

### PADO

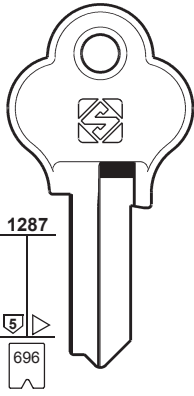

..... 1-2-3-4-5



PDO14



PDO14R

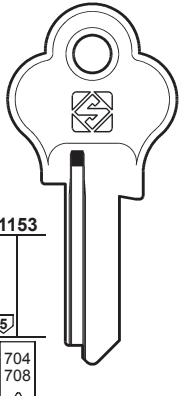

..... 1-2-3-4-5



PDO1R

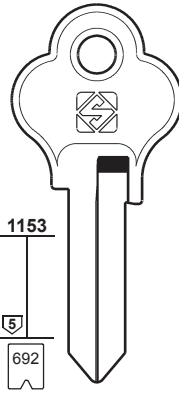

..... 1-2-3-4-5



PDO10R

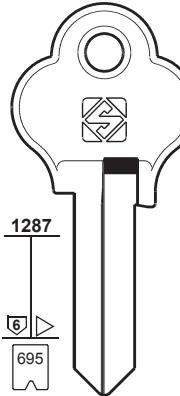

..... 1-2-3-4-5-6



PDO13



PDO13R

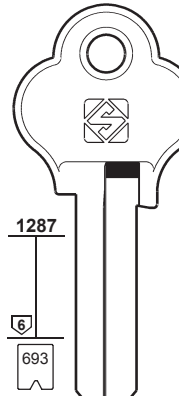

..... 1-2-3-4-5



PDO11

PER:  
FOR:

### PADO

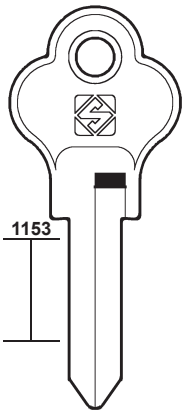

..... 1-2-3



PDO22



PDO22R

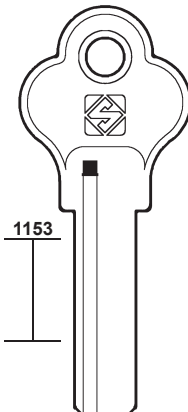

..... 1-2-3-4-5



PDO23

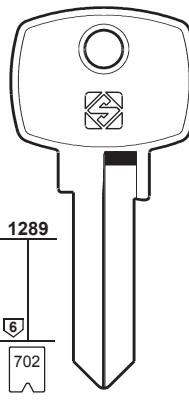

..... 1-2-3



PDO20



PDO20R

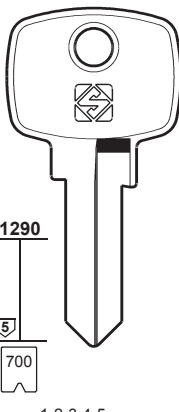

..... 1-2-3-4-5



PDO18



PDO18R

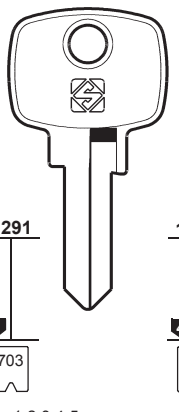

..... 1-2-3-4-5



PDO21



PDO21R

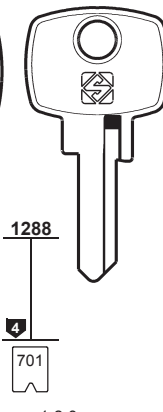

..... 1-2-3



PDO19



PDO19R



# 152

PER / FOR

**PANDA** (FR) (TW)

**PANTHER** (DE)

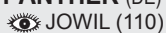

JOWIL (110)

**PAPAIZ** (BR)

PER: PANDA

FOR:

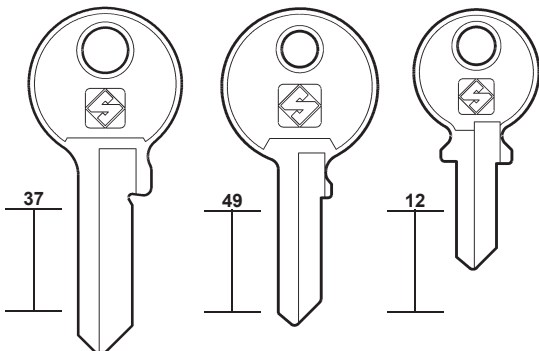

PAD3



PAD2



PAD1



PER: PAPAIZ

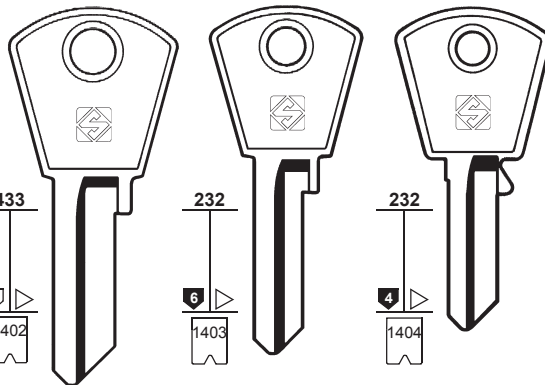

PZ1



PZ2



PZ3



mm 45-50-60-70



mm 35



mm 25-30

PER: PAPAIZ

FOR:

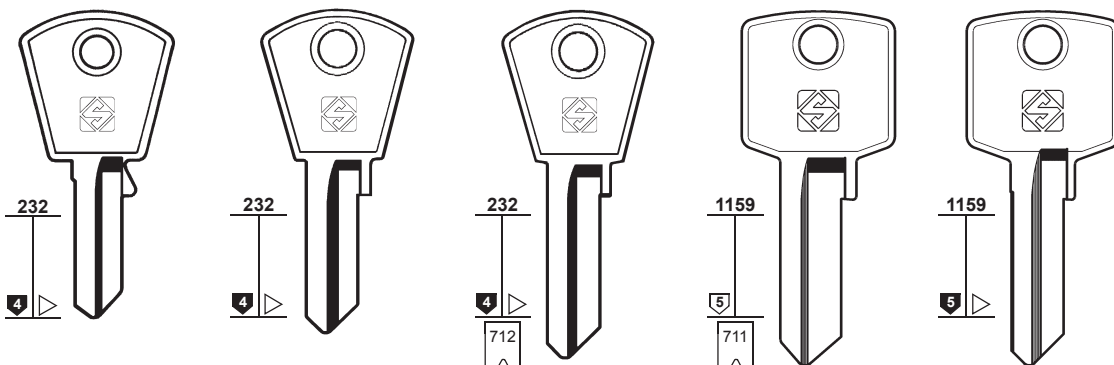

PZ4



PZ5



PZ6



PZ7



PZ8



mm 20



PER: PAPAIZ

FOR:

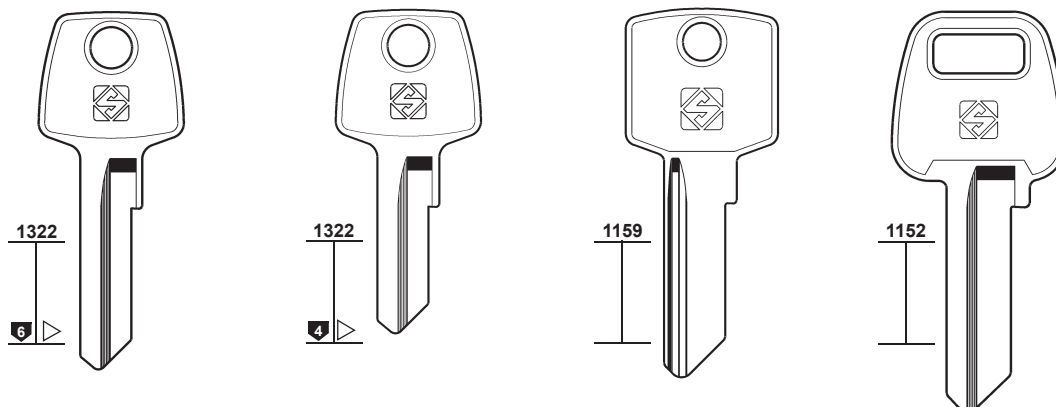

PZ9



PZ14



PZ18R



PZ17

PER:  
FOR:

### PAPAIZ

### PARMA



# 153

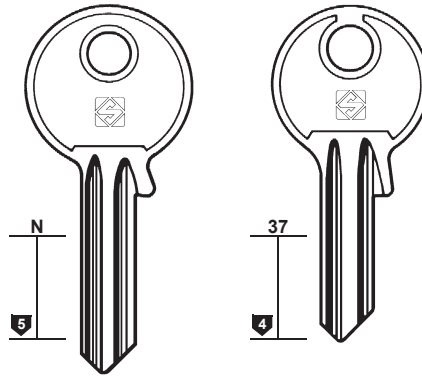
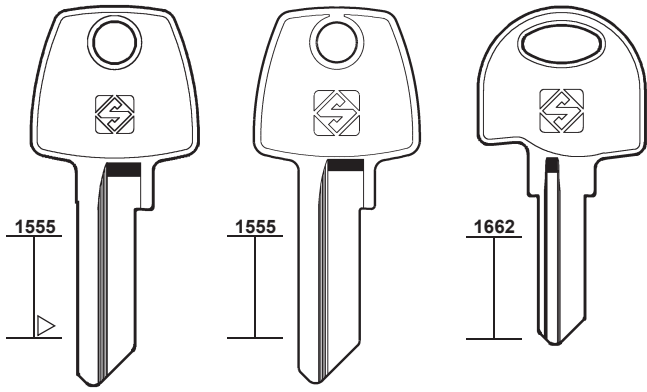

PER:  
FOR:

### P.C. (CORTELLEZZI)

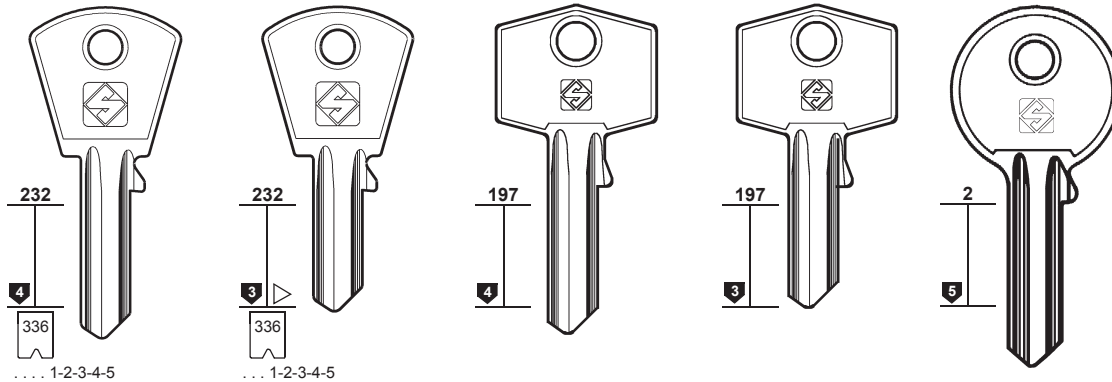

PER:  
FOR:

### P.C. (CORTELLEZZI)

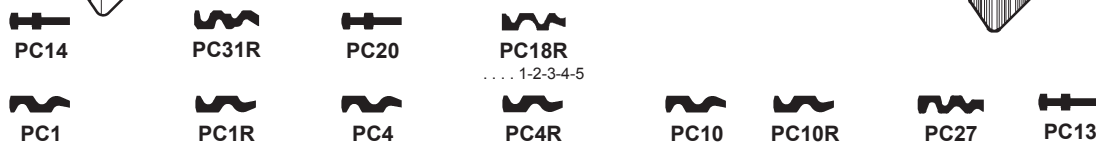
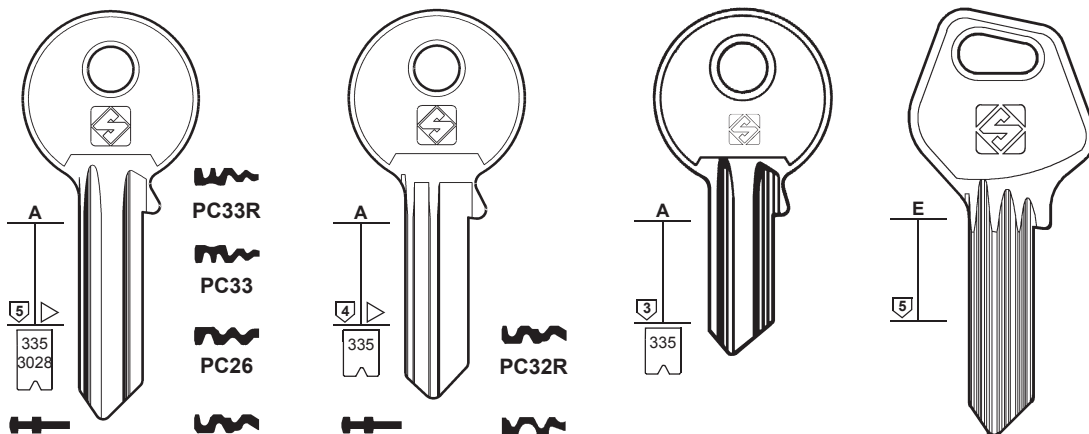

..... 1-2-3-4-5  
..... 1-2-3-4-5-6-7

ETNA - FEB - FPB  
FRAL - SANTOS - SAVIO

ETNA - FEB  
FPB - LUNA - PLODARI

PER / FOR

PAPAIZ (BR)

PARMA (IT)

PAS (IT)

👁️ PREFER (157)

PASSY (FR)

👁️ RICOUARD (160)

PASTORE (IT)

👁️ GIUSSANI (96)

👁️ PREFER (157)

P.B. (IT)

👁️ OLIVA (148)

P.C. (CORTELLEZZI) (IT)

ETNA

FEB

FPB

FRAL

GEVY

JVAL

LUNA

PLODARI

R.S.M.

SANTOS

SAVIO

SUL

+ 👁️ BIELLE (33)

+ 👁️ JVAL (112-113)



154

PER / FOR

**P.C. (CORTELLEZZI)** (IT)  
 CASMA  
 FEB  
 JVAL  
 SILCA  
 + BIELLE (33)  
 + JVAL (112-113)

**PENZA** (RU)

**PERINO PG** (IT)  
IMSI

**PEROHAUS** (FR)  
 DOM (69)  
 GEGE (93-94)  
 JUNIE (111)

**PERRIER** (FR)  
 G.R. (99)

**PETERBORO** (US)  
 DOMINION (74)

PER: P.C. (CORTELLEZZI)  
FOR:

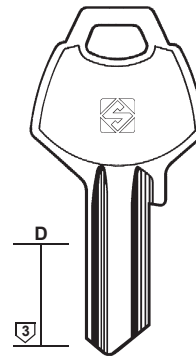
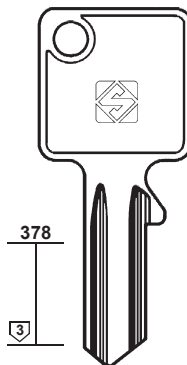
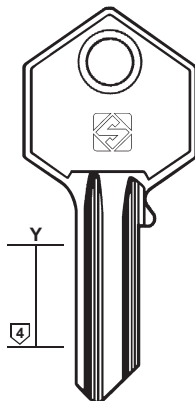
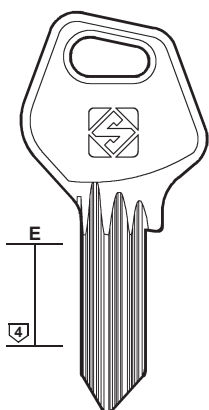

PC28



PC11



PC11R



PC5



PC5R

CASMA



PC9

CASMA

PER: P.C. (CORTELLEZZI)  
FOR:

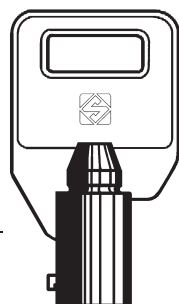

580

S251  
.....  
0123456

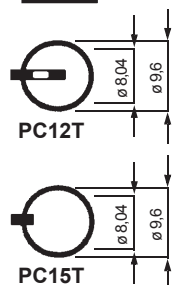

PC12T

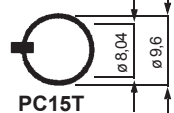

PC15T



FEB - JVAL

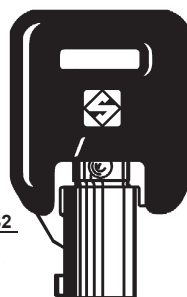

P132

S251  
.....  
0123456

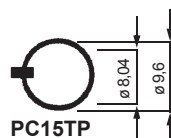

PC15TP

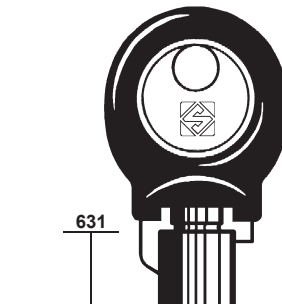

631

S251  
.....  
0123456

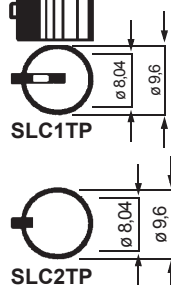

SLC1TP

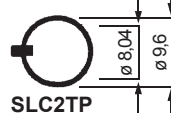

SLC2TP



SILCA

PER: PENZA  
FOR:

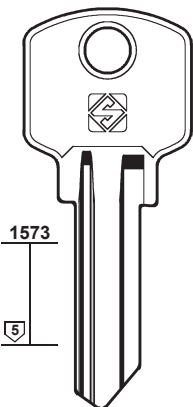

1573

5

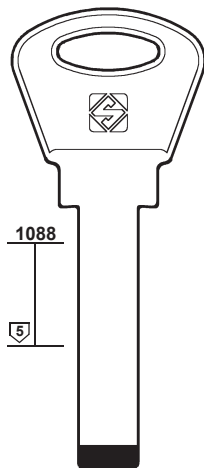

1088

5



BZ2



BZ2R



BZ3



IMSI

PERINO PG

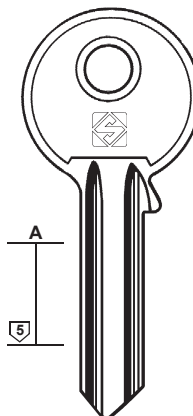

A

5

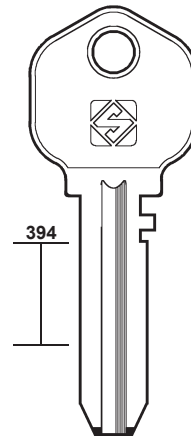

394



PG1



PG1R



PN1



IMSI

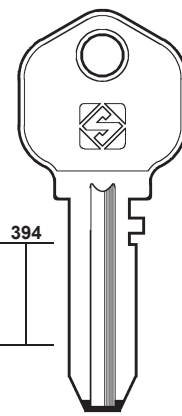

394



PN2



IMSI

PER:  
FOR: **PETROZAVODSK**

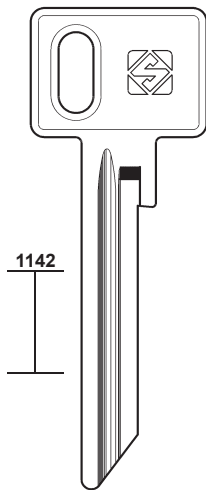

**PTZ1R**

**PFAFFENHAIN**

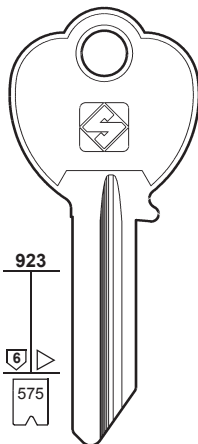

**PHF1R  
HK**

..... X-Y-0-1-2-3-4-5-6-7-8-9  
..... 25080-58049

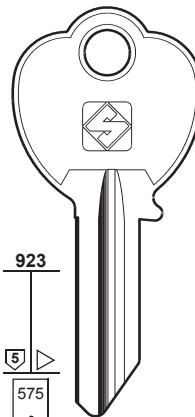

**PHF2R  
L**

..... 0-1-2-3-4-5-6-7-8-9  
..... 1-57036



**ABUS**

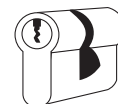

**155**

**PER / FOR**

**PETROZAVODSK (RU)**

**PFAFFENHAIN (DE)**  
ABUS  
BUVA

**PICARD (FR)**

👁️ BETA (33)  
👁️ KABA (113)

**PICARDIE (FR)**

DECAYEUX  
MODA  
S & E  
STS  
+ 👁️ AMARO LIMITADA (16)  
+ 👁️ FTH (91)  
+ 👁️ GABON (93)  
+ 👁️ SIS (170)  
+ 👁️ TITAN (182)

**P.J. (FR)**

👁️ RONIS (161)

**P.K. (FR)**

👁️ LAS (121)

**PLG (IT)**

👁️ GIUSSANI (96)

**PLODARI (IT)**

👁️ P.C. (153)

**PM (FR)**

👁️ RONIS (161)

**POLI (CL)**

**POPLOCK (IT)**

👁️ CORBIN (59-60)

**POS (DE)**

SIGENIA

PER:  
FOR: **PFAFFENHAIN**

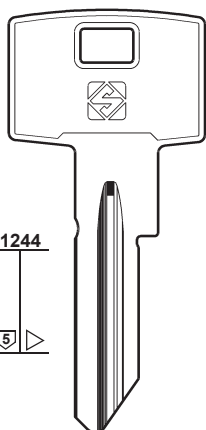

**PHF37**

**PHF28R**

**PHF29**

**PHF11R**

**PHF15**

**PHF10R**

**PHF12**

**PHF9R**

**PHF6**

**PHF8R**

**PHF4R**

**PHF5**

**PHF7R**

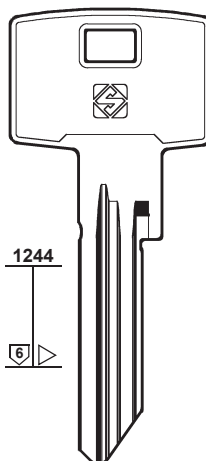

**PHF16R  
SRA**

**PHF34**

**PHF32**

**PHF23**

**PHF22R**

**PHF27R**

**PHF19  
EA**

**PHF27**

**PHF18R  
FD**

**PHF26R**

**PHF17  
ED**

**PHF26**

**ABUS - BUVA**

PER:  
FOR: **PICARDIE**

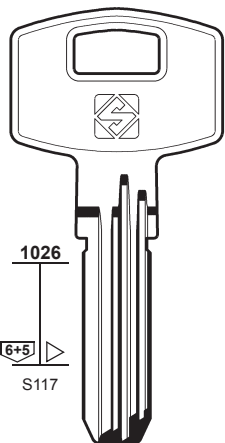

**PIC1**

DECAYEUX - MODA  
S & E - STS

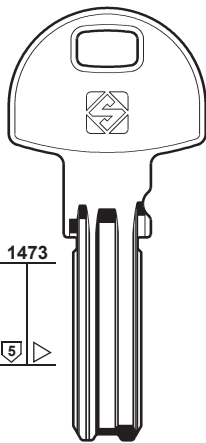

**PIC2**

**POLI**

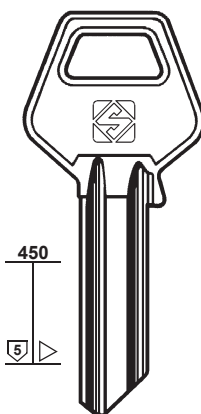

**PL1**

**POS**

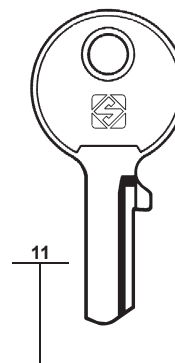

**PS1  
CZ**

**SIGENIA**



# 156

### PER / FOR

#### POTENT (IT)

AM  
MICHEL  
NONFANGO  
O.M.R.  
+ MICHEL (139)

#### PREFER (IT)

+ OLIVA (148)  
+ TRAU (188)

PER:  
FOR:

## POTENT

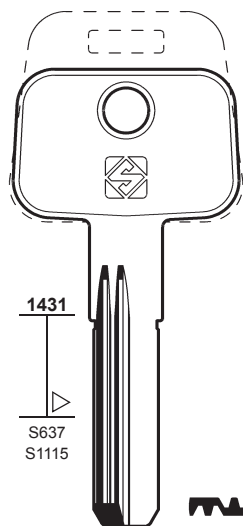

1431  
S637  
S1115



**PT4R**  
..... 1-2-3-4-5

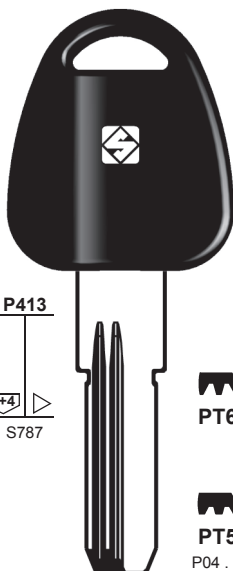

P413  
S787



**PT6RP**



**PT5RP**  
P04 .....  
1-2-3-4-5-6

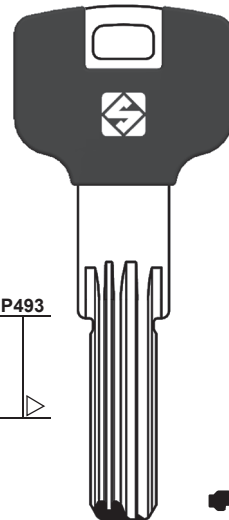

P493



**PT7RAP**

PER:  
FOR:

## POTENT

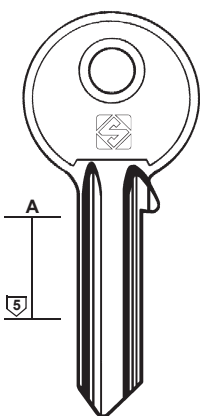

A  
5



**PT2**

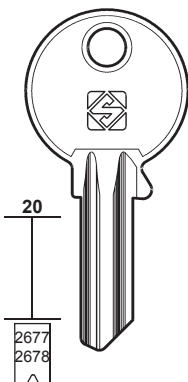

20  
2677  
2678



**MH1**  
..... 201-436



**MH1R**  
..... 437-672



MICHEL

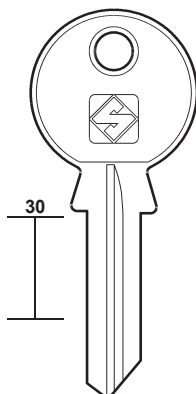

30



**MH2**



**MH2R**

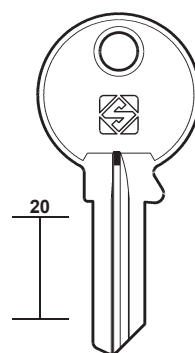

20



**PT1**



**PT1R**



AM  
MICHEL  
NONFANGO

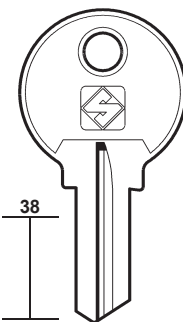

38



**MH4**



**MH4R**



MICHEL  
O.M.R.

PER:  
FOR:

## PREFER

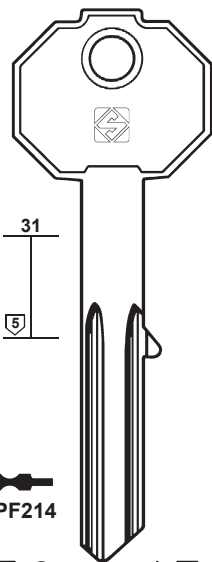

31  
5



**PF214**



**PF215**

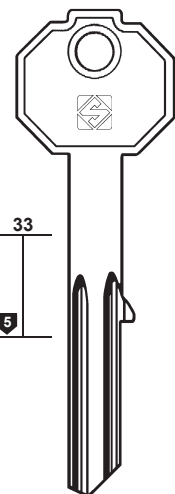

33  
5



**PF215R**



**PF3**



**PF3R**

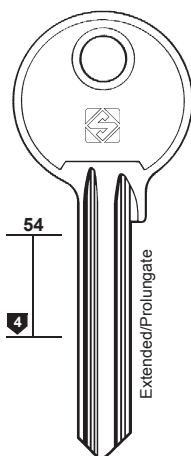

54  
3 4



**PF11**



**PF11R**

Extended/Prolungate

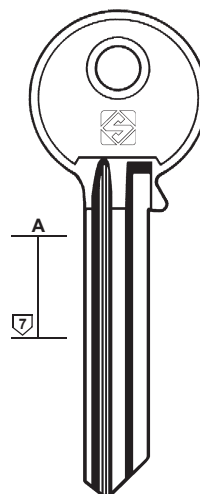

A  
7



**PF7**



**PF7S**

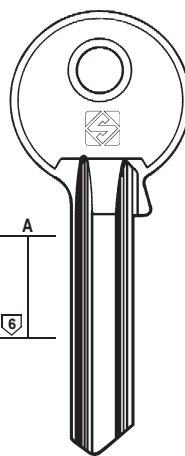

A  
6



**PF8**



**PF8R**

PER:  
FOR:

# PREFER

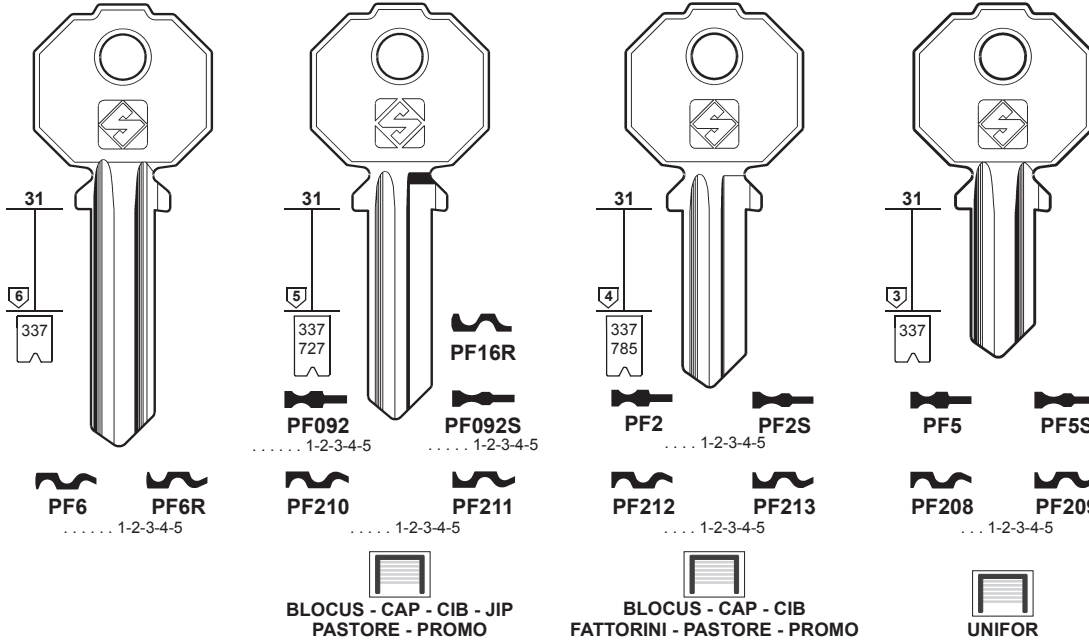

# 157

PER / FOR

- PREFER (IT)**  
 BLOCUS  
 CAP  
 CIB  
 FATTORINI  
 FOSAM  
 JIP  
 LIPS VAGO  
 METACASTELLI  
 NONFANGO  
 O.M.R.  
 PAS  
 PASTORE  
 PROMO  
 SERITAL  
 SWEDA  
 UNIFOR  
 + OLIVA (148)  
 + TRAU (188)

PER:  
FOR:

# PREFER

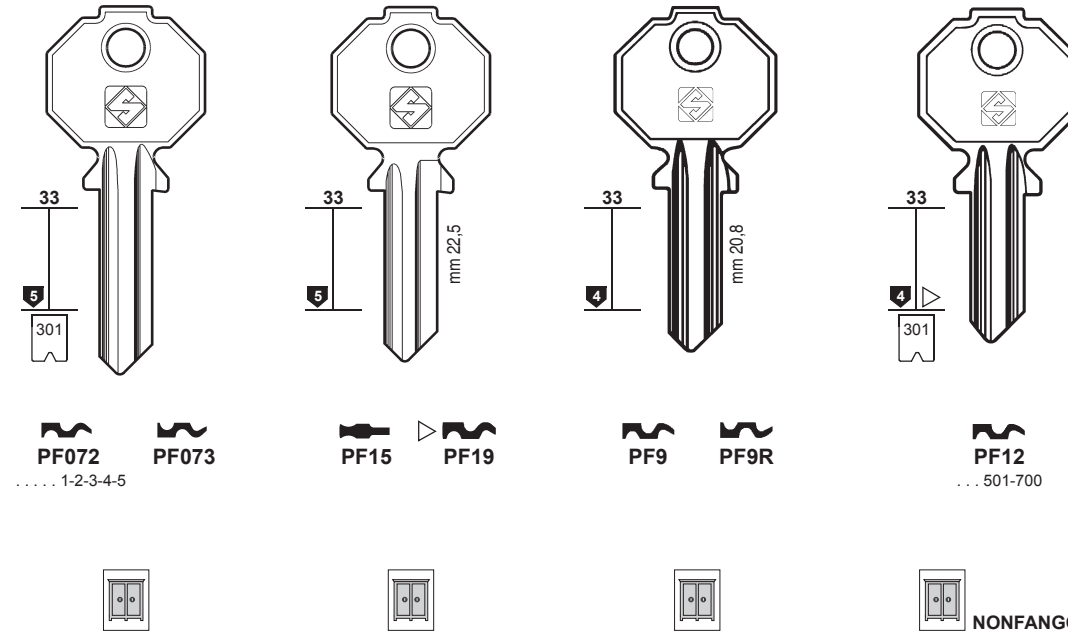

PER:  
FOR:

# PREFER

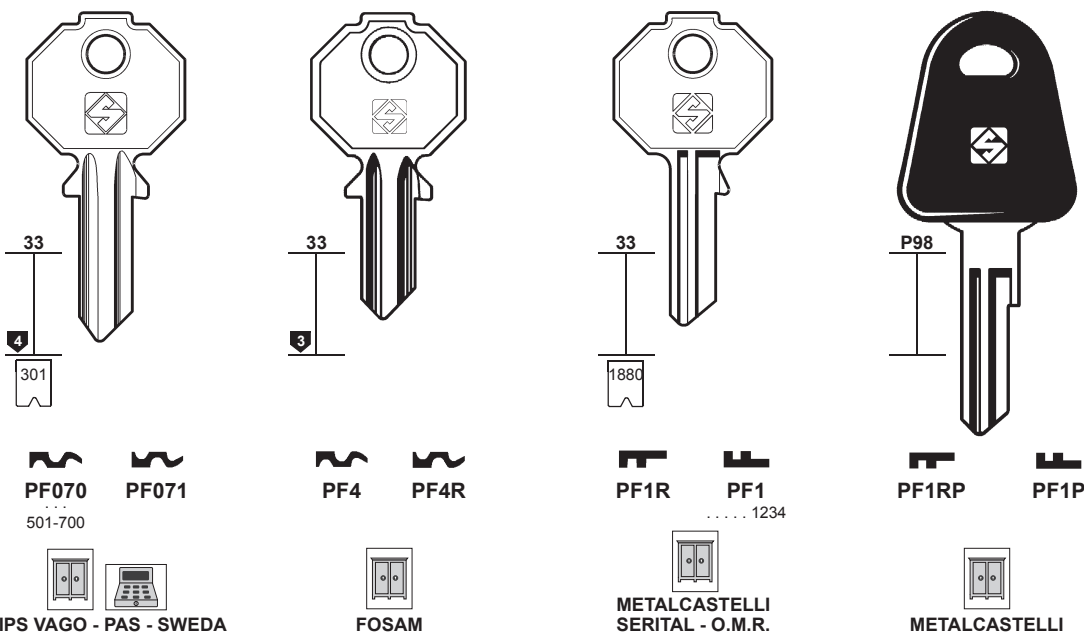



# 158

### PER / FOR

#### PREFER (IT)

IMBAC

+ OLIVA (148)

+ TRAU (188)

#### PRESTA (DE)

+ BOMORO (37)

+ LA PORTE (121)

#### PRIM (CH)

SWEDA

#### PRIVE (AR)

+ YALE (212)

#### PROBAT (FR)

+ FTH (91)

#### PROFILMAR (FR)

#### PROMECA (FR)

+ RONIS (161)

#### PROMETA (IT)

#### PROMO (IT)

+ PREFER (157)

#### PROTEC (FR)

+ CITY (58)

+ KVR (119)

#### PUNDRA (US)

#### QCP (FR)

+ CITY (58)

+ ZENITH (222)

#### RABBIT (HK)

#### RAFI (DE)

+ DOM (69)

#### RAM (TW)

+ YETI (218-219)

#### RAMIS (EG)

#### RAUCO (DE)

+ HEKNA (102)

#### R.C. (IT)

+ CRISTANI (63)

#### READING (US)

+ SEGAL (167)

#### RECA (IT)

+ INDESIT (107)

#### REDY (IN)

+ LOB (126)

#### REGAL (GB)

#### REGENT (US)

+ HEKNA (102)

+ HENDERSON (102)

+ SIDLEEN (169)

PER:  
FOR:

## PREFER

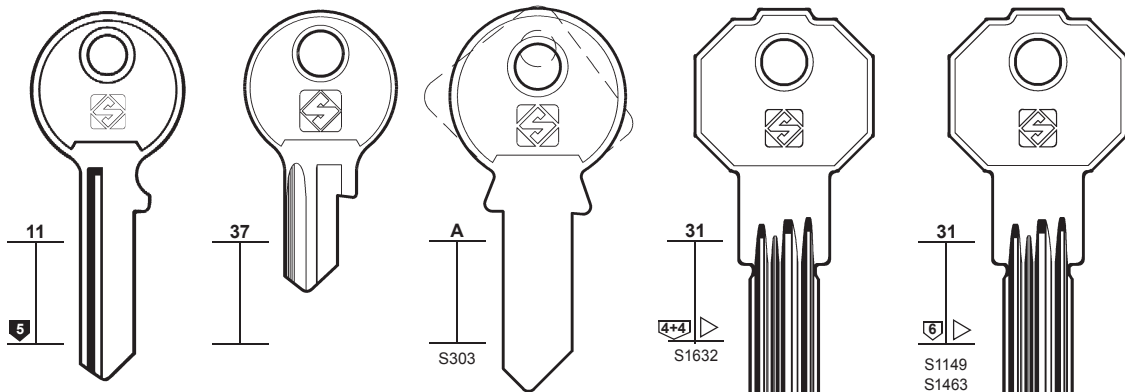

PF13R



PF14



PF18



PF22



PF20



PF21



IMBAC



PER:  
FOR:

## PRIM

## PROFILMAR

## PROMETA

## PUNDRA

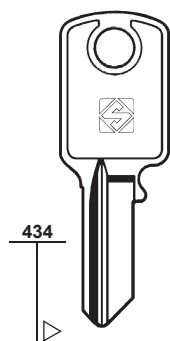

PRI3R



SWEDA

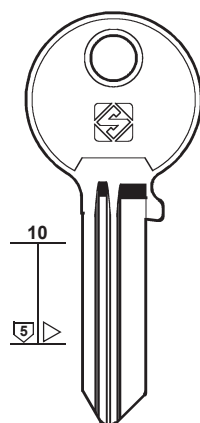

PRL1

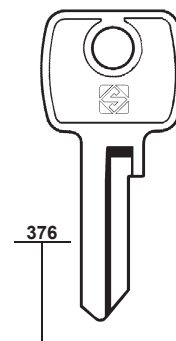

PM1

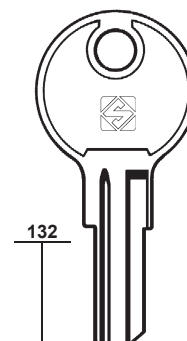

PD1

PER:  
FOR:

## RABBIT

## RAMIS

## REGAL

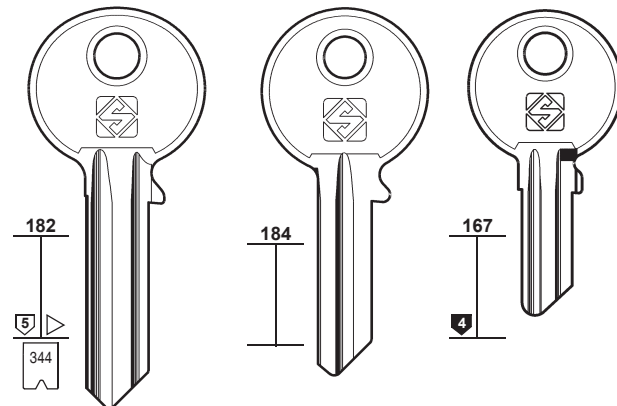

YA1



YA1R



RBT1R



RBT2

0-1-2-3-4-5-6-7-8-9

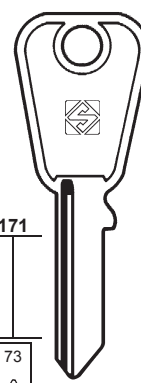

UNI12

FP ...  
626-750

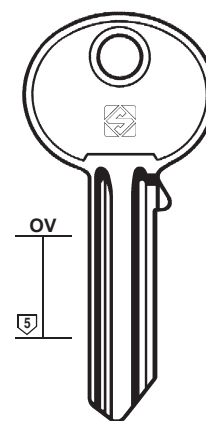

RG1



PER:  
FOR:

**REGISTRATORI  
DI CASSA**

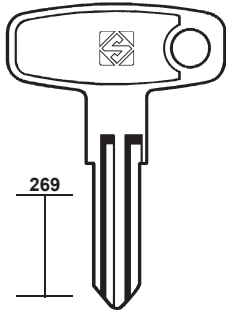

269



**RDC1  
Z**



**RELIANCE**

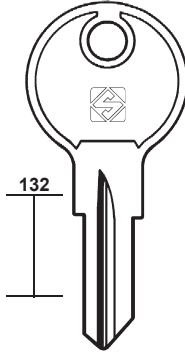

132



**REL1R**



**REL2**

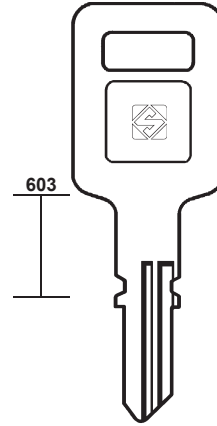

603



**REL3**



**159**

PER / FOR

**REGISTRATORI DI  
CASSA (IT)**

**RELIANCE (JP)**

**REMO (IT)**  
 ICSA (105)

**RENZ (DE)**  
 ATAL  
 + KIFERM (117)  
 + LAS (121)

PER:  
FOR:

**RENZ**

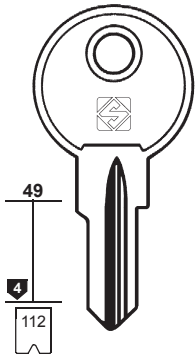

49



**KI5**

C... 1-275  
XS... 1-275

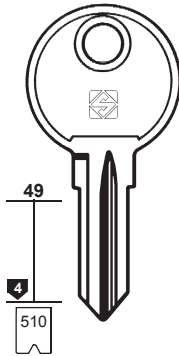

49



**KI5R**

SX... 1-275  
XT... 1-75  
RX... 1-275

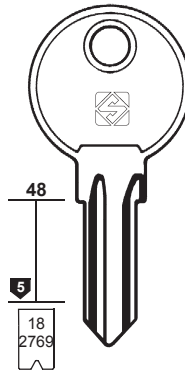

48



**KI12**

... 151-218  
... 101-150  
... 1116-7776  
H... 1116-7776  
E... 425-499



**KI12R**

... 1-68  
... 51-100  
H... 500-574  
E... 1116-7776



**LS1**

R... 1-224



**LS1R**

V... 1-224

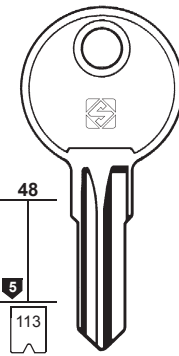

48



**LS2**

AX... 1-224



**KI7**

XY... 1-275

ATAL



PER:  
FOR:

**RENZ**

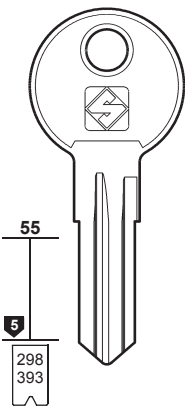

55



**REN1**



**REN1R**

... 1-200

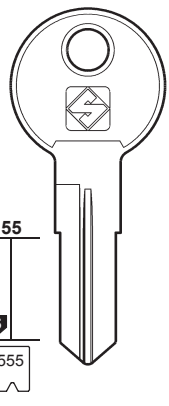

55



**REN2**



**REN2R**

32... 001-200

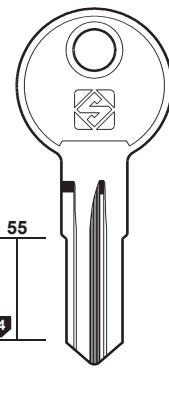

55



**REN3R**

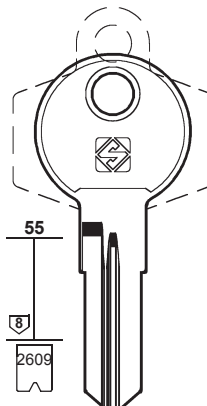

55



**REN5**

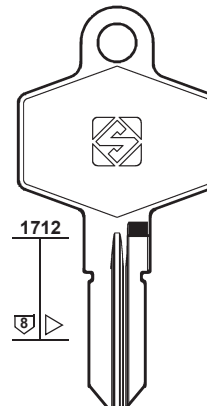

1712



**REN6**



**REN6R**





# 160

PER / FOR

**RESMINI** (IT)

**REX** (DK)

**RGM** (ES)

**RICOUARD** (FR)

COUILLET  
DECAYEUX  
KIFERM

LAS

PASSY

YVEL

**RIGA** (LV)

**RIPA** (ES)

IFAM (105-106)

**RIQUIER** (FR)

G.R. (99)

**RIV** (ES)

UCEM (192)

**RIVERS** (AU)

**RJAZAN** (RU)

**ROC** (FR)

YALE (212)

**ROLEX** (GR)

ZANETTI A. (220)

**ROLL-A-DOOR** (GB)

LEN-LOK (122)

L & F (129)

**ROMA** (IT)

**RONEO** (ES)

RONIS (161)

PER:  
FOR:

**RESMINI**

RM1A    RM1RA    RM2A    RM2RA

PER:  
FOR:

**REX**

RX2    RX1  
K... 1-50

PER:  
FOR:

**RGM**

RGM1    RGM1R

PER:  
FOR:

**RICOUARD**

RIC1  
K... 726-950

COUILLET - DECAYEUX  
KIFERM - LAS - PASSY - YVEL

PER:  
FOR:

**RIGA**

RGA1

PER:  
FOR:

**RIVERS**

RV1

PER:  
FOR:

**RJAZAN**

RZA1    RZA2    RZA3

PER:  
FOR:

**ROLL-A-DOOR**

RD1    RD2  
19... 1-420

PER:  
FOR:

**ROMA**

RA1    RA1R

PER:  
FOR:

# RONIS

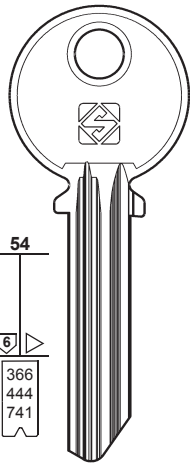

K .....  
KK .....  
N .....  
NN .....  
123456789

**RO9 RO9R**  
ANTAR  
LAPERCHE - SESA

UUL .....  
**RO23 RO23R**  
FL  
LAPERCHE

UUK .....  
**RO25 RO25R**  
FK  
LAPERCHE

UUM .....  
**RO27 RO27R**  
FM  
LAPERCHE

**RO47 RO47R**

..... 1-1296  
V20 ..... 1-1296  
..... 1234567890  
A/Z ..... 1234567890

**RO41 DAD**

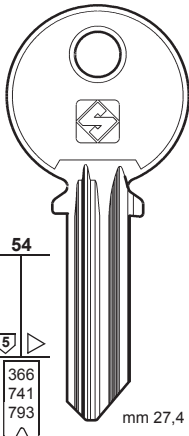

MX ..... 1100-1699  
A/Z ..... 12345678  
..... A/Z 12345678  
ANTAR ..... 123456789  
BLOCUS ..... 9 ..... 123456789  
CATOR ..... J ..... 123456789

DC  
DEBEURAIN  
DELTA  
DERLOCHE  
DESPREZ  
EMGE  
EMHART  
EQUIBATIR  
FONTAINE  
FORINDEX  
GOLLOT  
GUIDOTTI  
JIP  
LAPERCHE  
LIONA-LIOX  
MAFOR  
MONDIAL  
MOREAUX  
NUMIDIA  
PM  
PROMECA  
SESA  
SOFRANQ  
STREMLER  
VEGA

TTL .....  
**RO22 RO22R**  
FL  
LAPERCHE

TTK .....  
**RO24 RO24R**  
FK  
FONTAINE  
LAPERCHE

TTM .....  
**RO26 RO26R**  
FM  
LIONA-LIOX  
LAPERCHE

**RO37 RO37R**  
ET

.....  
0-1-2-3-4-5-6-7-8-9

**RO8R**  
..... 9 123456789  
..... N 123456789

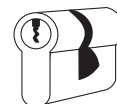

# 161

PER / FOR

**RONIS (FR)**

ANTAR  
BLOCUS  
ARMOR  
CATOR  
DAD  
DAV  
DC  
DEBEURAIN  
DELTA  
DERLOCHE  
DESPREZ  
EMGE  
EMHART  
EQUIBATIR  
FONTAINE  
FORINDEX  
GIMM  
GOLLOT  
GUIDOTTI  
JIP  
KARDEX  
LAPERCHE  
LIONA-LIOX  
MAFOR  
MLM  
MONDIAL  
MOREAUX  
NEMEF  
NUMIDIA  
P.J.  
PM  
PROMECA  
RONEO  
SANEL  
SCHÄFER  
SESA  
SOFRANQ  
SOLOR  
STRAFOR  
STREMLER  
VEGA  
YAC

+ EMKA (77)  
+ LAS (121-122)  
+ VACHETTE (199)

PER:  
FOR:

# RONIS

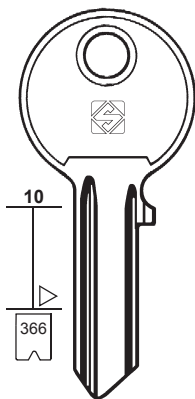

**RO7 RO7R**  
..... 0-1-2-3-4-5-6-7-8

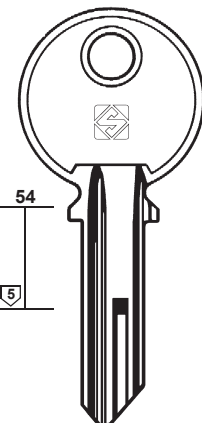

**RO13**

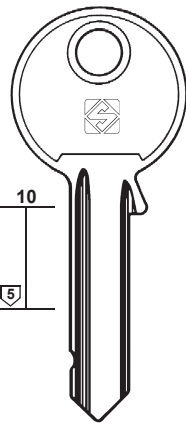

**RO14**

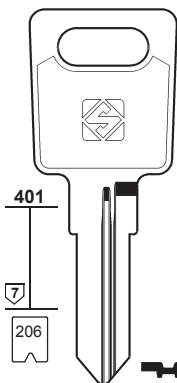

**RO67**  
NA .....  
4001-5000

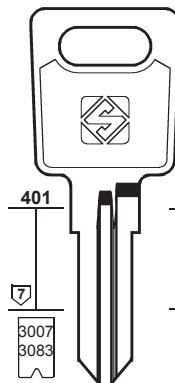

**RO67R**  
ND .....  
4001-5000

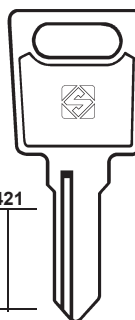

**RO69**  
CC ..... 1-2000

**RO46R**

ANTAR - GIMM  
JIP - LAPERCHE  
PM - SESA

SOLOR

CATOR

**RO68**  
NC .....  
4001-5000

**RO68R**  
NB .....  
4001-5000

**RO85**

PER:  
FOR:

# RONIS

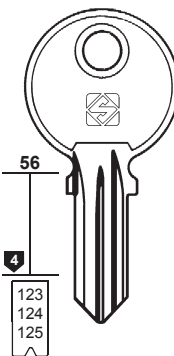

**RO15 RO15R**  
A8 .. AA-DS  
.. 8 AB-ZZ  
S ... 385-402

P.J.

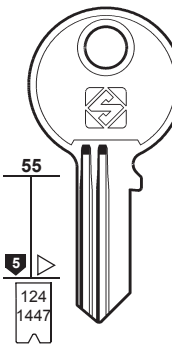

**RO4**  
D ..... 1-1000  
S ..... 1-106  
T ..... 1-106  
..... 11 1-200  
A ... A 1-200  
F ... 1-200  
1F ... 1-21  
TA ... 1-224  
PS ... 1-30  
GV ... 1-300  
... F 1-500  
... C 101-600  
C ... 101-600  
C ... 11111-44444  
... A ... 12345  
00 ... 12345  
C ... 12345  
T ... 313-380  
... 11 501-700  
A ... A 501-700

**RO45**

EMHART - MLM  
NEMEF - SCHÄFER

**RO4R**  
E ..... 1-1000  
... 15 1-200  
... Y 101-600  
Y ... 101-600  
S ... 107-212  
T ... 107-246  
Y ... 11111-44444  
Y ... 12345  
1F ... 22-29  
T ... 381-400  
... 15 501-700

**RO48R**

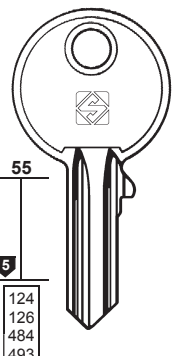

**RO20**  
E ..... 12345  
2 ..... 12345  
F ..... 12345  
S ..... 247-279  
T ..... 247-279  
1F ... 30-33  
... 400-520  
2 ... 400-520  
... E 601-800  
E ... 601-800

**RO30**  
F ... 1-500  
Z ... 1-900

**RO38**

**RO42**

**RO50**  
B ... 1-20

**RO20R**  
A ..... 12345  
S ... 280-312  
T ... 280-312  
... A 400-520  
A ... 601-800  
A ... 601-800  
**EMKA**

**RO30R**

**RO38R**  
H ... 1-1000

**RO42R**  
... ZA1-ZZ3



ARMOR - DAV - FORINDEX - KARDEX  
RONEO - SANEL - STRAFOR - YAC



# 162

### PER / FOR

#### RONIS (FR)

- BURG
- STRAFOR
- TAV
- + EMKA (77)
- + LAS (121-122)
- + VACHETTE (199)

#### ROSSETTI (RO)

#### ROSTEX (CZ)

- LOB (125)

#### ROYAL (TW)

- ABUS (8)
- COLE (59)
- GUARD (100)
- VIRO (206)
- YETI (218-219)

#### R.S.M. (GB)

- P.C. CORTELLEZZI (154)

#### RUFFLER & DEITH (GB)

- SIDLEEN (169)

#### RUFFLER & WALKER (GB)

- SIDLEEN (169)

#### RUKA (DE)

- DOM (68)
- VACHETTE (198)

#### RUKO (DK)

- ASSA
- DIFA

PER:  
FOR:

## RONIS

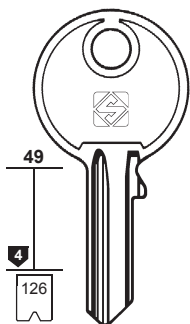

RO44



RO34

N... 601-983



RO21

... 601-983

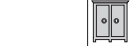

BURG - STRAFOR - TAV

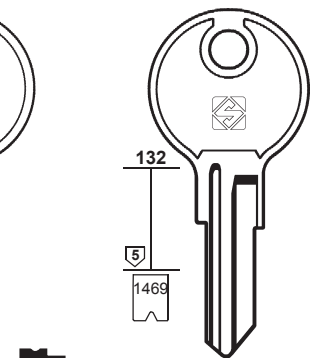

RO44R



RO34R

P... 601-983



RO21R

M... 601-983

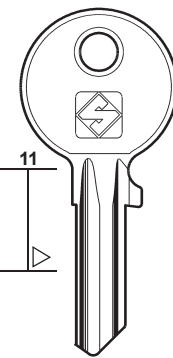

RO49



RO51

CH... 101-751  
GZ... 101-751

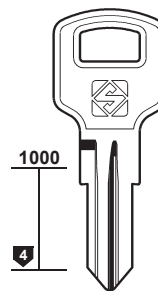

RO53R

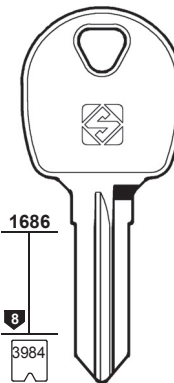

RO84  
..... 12345

PER:  
FOR:

## ROSSETTI

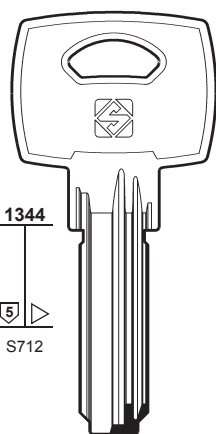

... 1-2220

RSS3



PER:  
FOR:

## ROYAL

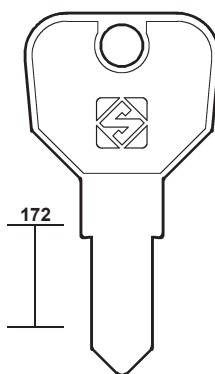

ROY1

PER:  
FOR:

## RUKO

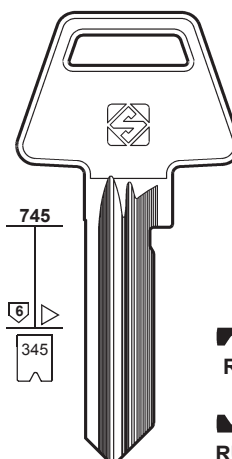

RU14  
..... ABCDEFGHJ

RU24R

ASSA

RU25

RU25R

RU26

RU27

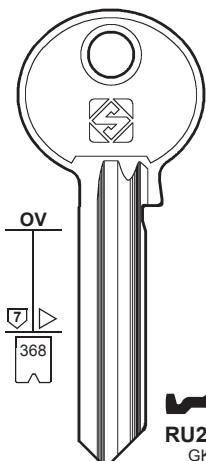

RU6

1-2-3-4-5-6-7-8-9-A-B-C

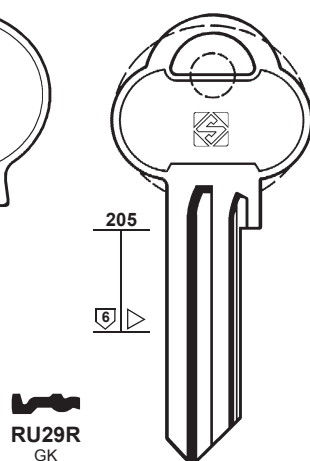

RU23R  
GM

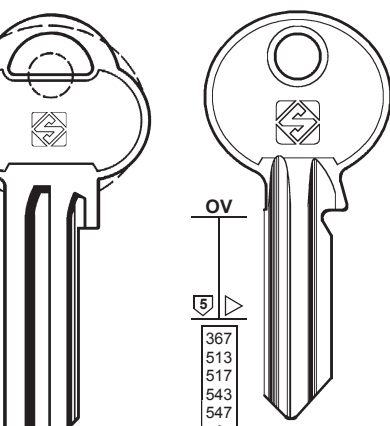

RU15R

RU1

RU1R  
..... 1-2-3-4-5-6-7-8  
..... 1-2-3-4-5-6-7-8-9  
..... 1-2-3-4-5-6-7-8-9-0-A-B  
..... 0-1-2-3-4-5-6-7-8-9-A-B-C-D-E-F-G-H-L-M  
S..... 1-2-3-4-5-6-7-8-9

DIFA

RU2R

RU2

RU16

RU19

RU3R

RU3

RU20  
HNR

RU21  
ALR

RU4

RU4R

RU22R  
GMR

RU5

RU5R

RU28

RU7

RU30  
TL

RU8R  
GC

RU9R  
GK

RU10R  
GL

RU11R  
GM

RU12  
AK

RU13  
AM

PER:  
FOR:

### RUSSIA

### RUSSWIN



# 163

PER / FOR

RUSSIA (RU)

RUSSWIN (US)

S-TECH (GB)

SAB (IT)

TAMPALINI (179)

SABI (EG)

SAFE (IT)

SAM (RU)

SAMA (FR)

FTH (91)

SAMSONITE (US)

SANCHUN (TW)

YETI (218-219)

SANEL (FR)

RONIS (161)

SANPEUR (FR)

VACHETTE (198)



RW7R



RW8R

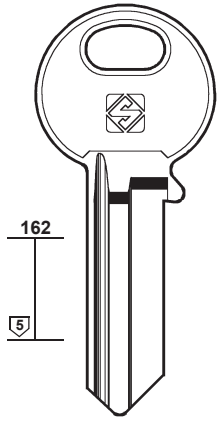

162



RUS4

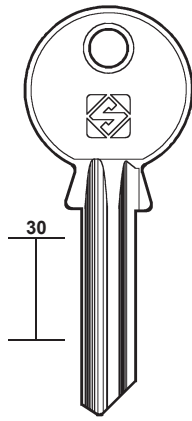

30



RUS5

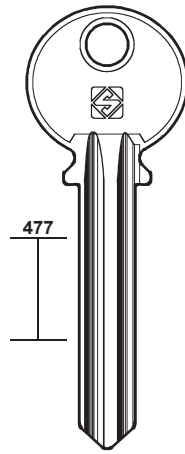

477



RUS6

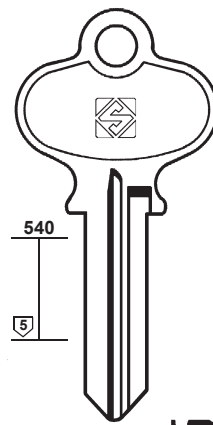

540



RW25

PER:  
FOR:

### S-TECH

### SABI

### SAFE

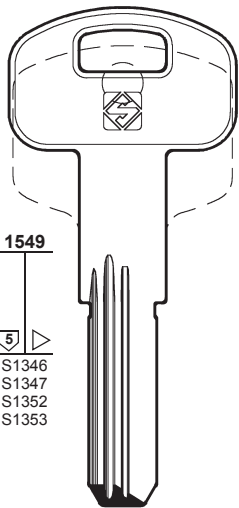

1549



S1346  
S1347  
S1352  
S1353

SCH1R

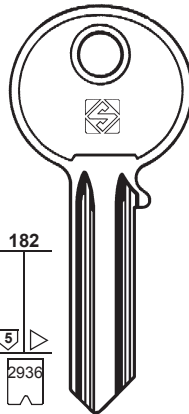

182



2936

.....01234567

SB1

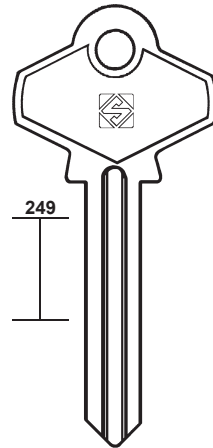

249

SF1

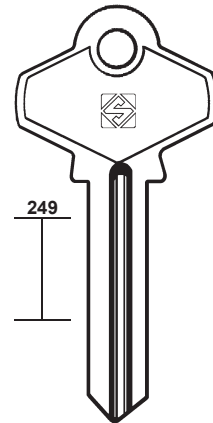

249

SF2

PER:  
FOR:

### SAM

### SAMSONITE

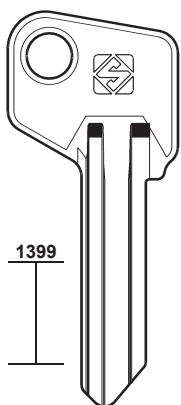

1399

SMA1

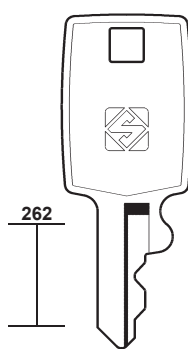

262

SA1  
170 S

SA1R

SA2  
70 S

SA2R

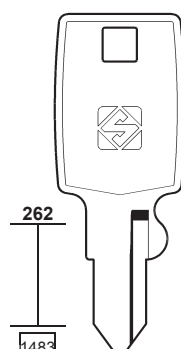

262

1483

SA4

SE... 41-186

SA3  
SE... 315-396

SA3R  
SE... 231-294

SA5

SA5R





# 164

PER / FOR

**SÄNTIS** (CH)  
+ CES (47)

**SANTOS** (PT)  
 OMEC (149)  
 P.C. (CORTELLEZZI) (153)

**SANWA** (JP)

**SANY** (FR)  
 ALPHA (16)

**SARATOV** (RU)

**SARGENT** (US)

## PER: FOR: SÄNTIS

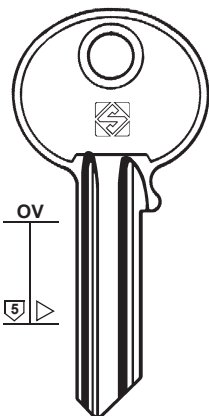

## SANWA

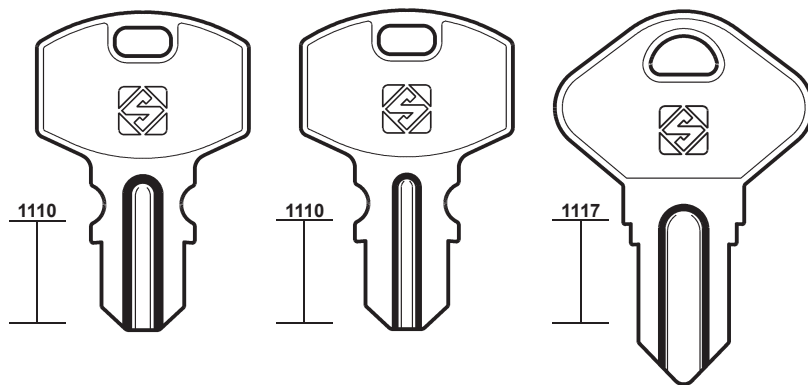

## PER: FOR: SARATOV

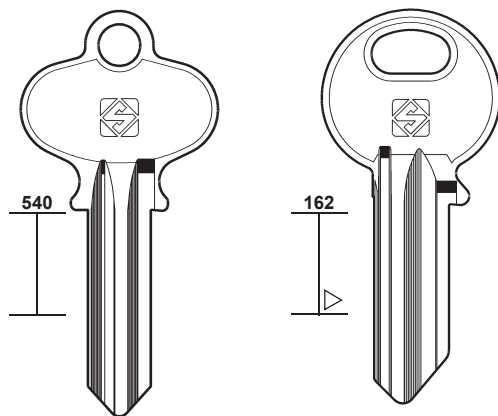

## SARGENT

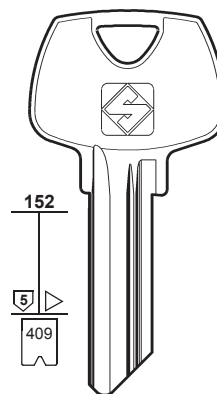

1-2-3-4-5-6-7-8-9-0

## PER: FOR: SARGENT

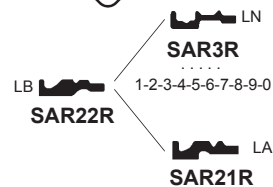
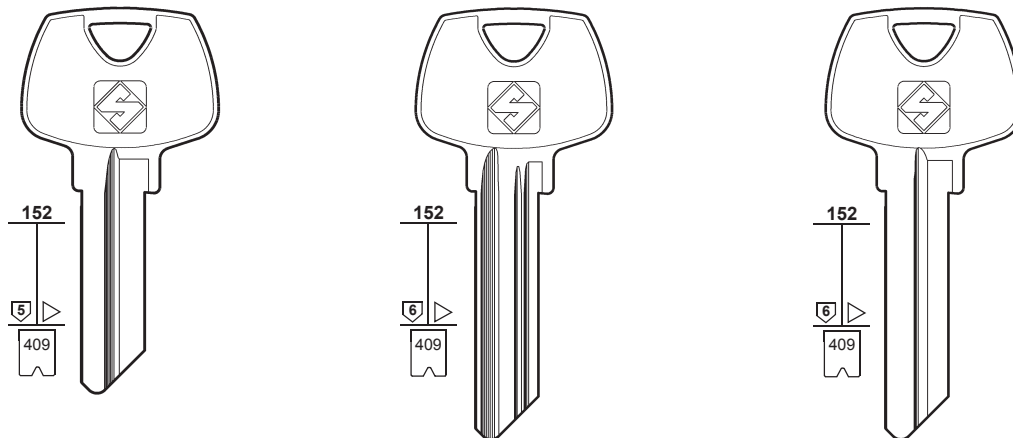

PER:  
FOR:

# SARGENT

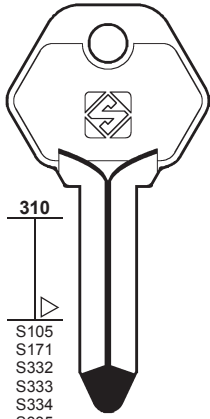

310

S105  
S171  
S332  
S333  
S334  
S335  
S336  
S598  
S599  
S600  
S601



KE4



KESO

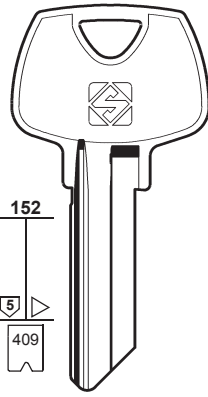

152

5  
409



SAR1

S

1-2-3-4-5-6-7-8-9-0

BRICARD - SHOWA

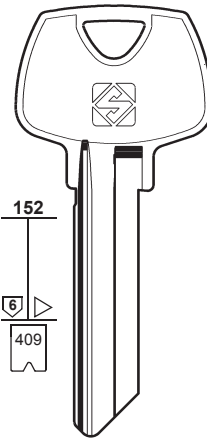

152

6  
409



SAR2

S



SAR4R

1-2-3-4-5-6-7-8-9-0

BRICARD - SHOWA



# 165

PER / FOR

**SARGENT (US)**  
BRICARD  
KESO  
SHOWA

**SARGENT & GREENLEAF (US)**  
SLAYMAKER (171)

**SATURN (SI)**  
BASI  
GERA  
VERA

**SAVE (CZ)**

**SAVIO (I)**  
AGB (11-12)  
JVAL (112)  
P.C. (CORTELLEZZI) (153)

**SCHÄFER (DE)**  
RONIS (161)

**SCHÄRF (DE)**  
HUWIL (104)

**SCHLAGE (IT) (US)**  
EPO

PER:  
FOR:

# SATURN

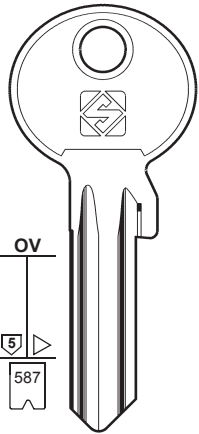

OV

5  
587



STU1

1-2-3-4-5-6-7-8-9

GERA - VERA

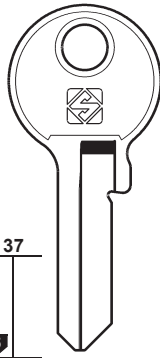

37

5



STU3



mm 50

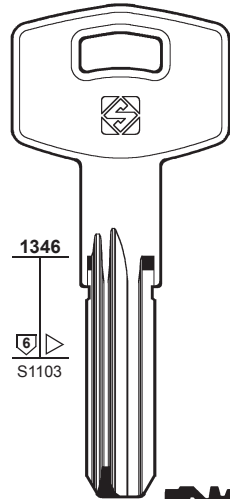

1346

6  
S1103



STU6R



BASI

# SAVE

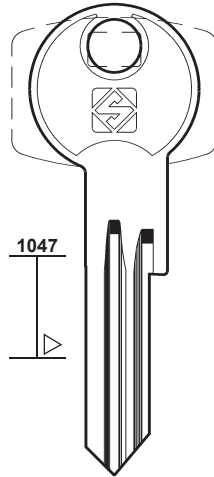

1047



SVE1R

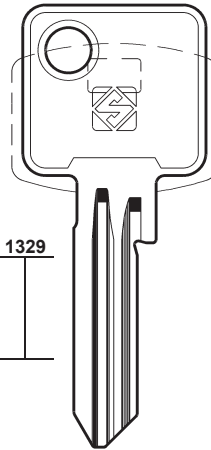

1329



SVE2R

PER:  
FOR:

# SCHLAGE

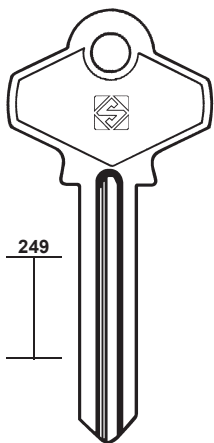

249



SH1

A

EPO

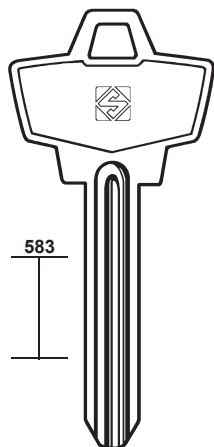

583



SH2

W

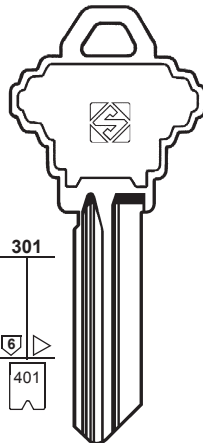

301

6  
401



SH5R



SH27

A/Z ..... 0123456789  
A/Z-A/Z ..... 0123456789

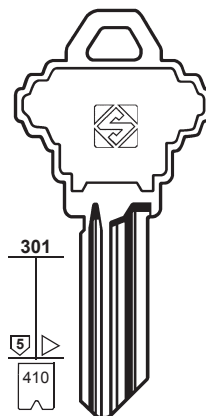

301

5  
410



T SH12R

A/Z ..... 0123456789  
A/Z-A/Z ..... 0123456789



# 166

PER / FOR

**SCHLAGE** (IT) (US)  
BALDWIN  
TACO

**SCHLECHTENDAHL** (DE)  
CASI  
HUTRA  
NORDWEST

**SCHLEGEL** (DE)  
DOM (68)

**SCHÜCO** (DE)  
CISA (55)  
KFV (116)

**SCHULTZ** (DE)  
EURO LOCKS (78)

**S & E** (FR)  
PICARDIE (155)

**SE** (FR)  
G.R. (99)

**SEA** (CH)  
EZCURRA  
HASLER  
VIDMAR

PER:  
FOR:

## SCHLAGE

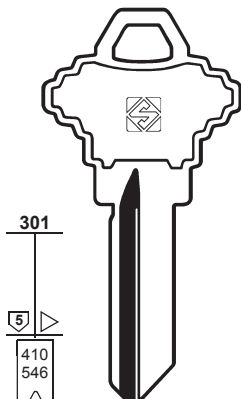

301  
410  
546

..... 0123456789 C  
..... A 0123456789  
S ..... 100-27787

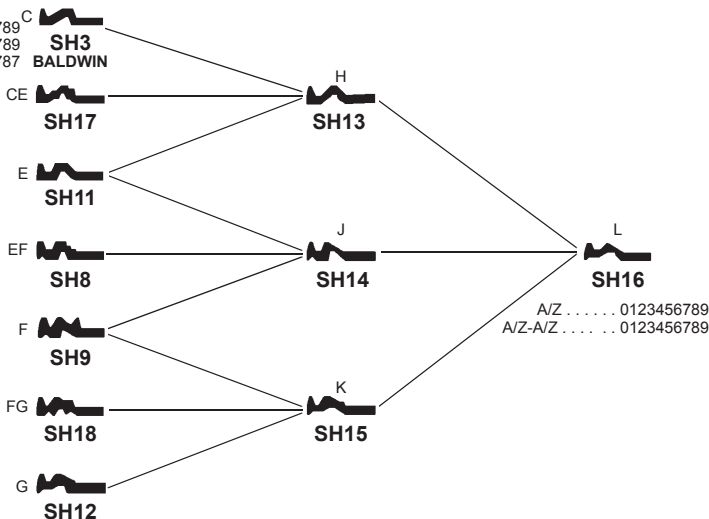

TACO

PER:  
FOR:

## SCHLAGE

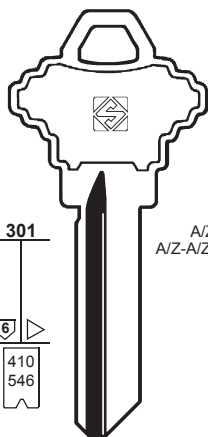

301  
410  
546

..... DG C  
0123456789

A/Z ..... 0123456789  
A/Z-A/Z ..... 0123456789

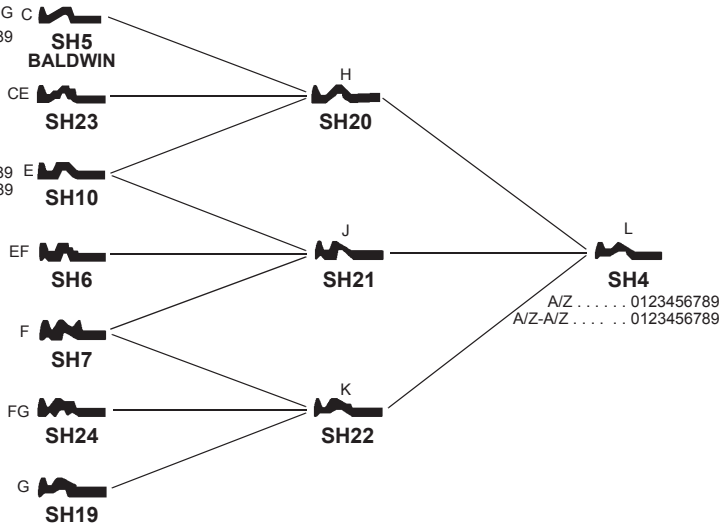

TACO

PER: **SCHLECHTENDAHL**  
FOR:

**SEA**

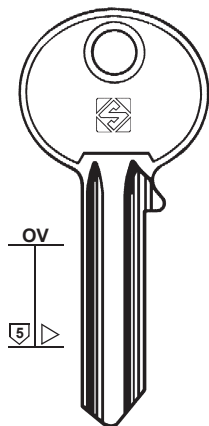

OV  
5

ST1

CASI - HUTRA - NORDWEST

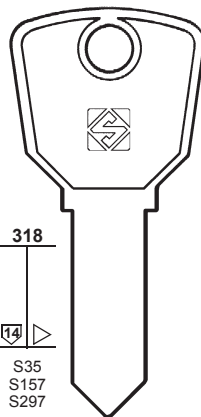

318  
14

S35  
S157  
S297

SEB1  
20-23



EZCURRA - HASLER

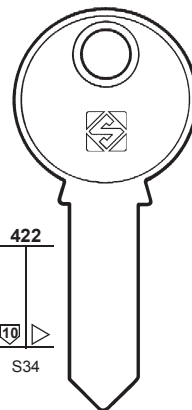

422  
10

S34

SEB2



EZCURRA - HASLER - VIDMAR

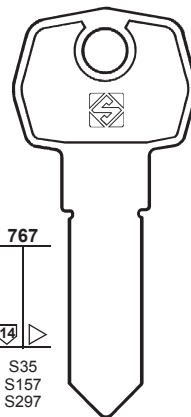

767  
14

S35  
S157  
S297

SEB3  
20-23



EZCURRA - HASLER - VIDMAR



PER:  
FOR:

### SEAT

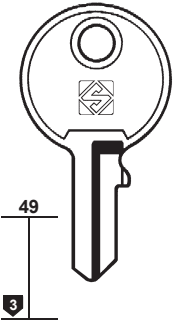

SEA4

SEA4R



MICHEL - SICCAF

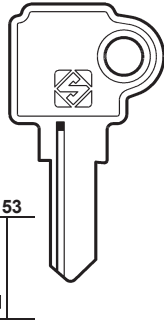

SEA5 SEA5R

SEA7 SEA8



### SECURE

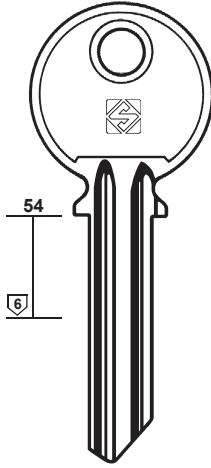

SC1

STA-LOCK

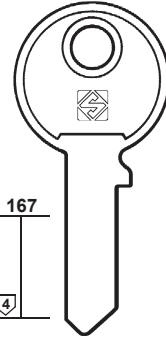

SC2

STA-LOCK



# 167

PER / FOR

SEAT (IT)  
MICHEL  
SICCAF

SECURE (GB)  
STA-LOCK

SECUREMME (IT)

SECURIT (FR)

SECURITAL (IT)  
KYR

+ ABUS (9)  
+ FORT (90)

SEEBURG (US)  
ILLINOIS (106)

SEGAL (US)  
HUDSON  
READING

SEIM (FR)  
KIFERM (117)

SEKUR (AR)

PER:  
FOR:

### SECUREMME

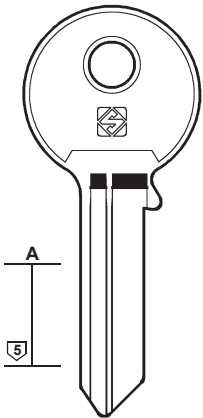

SCM4

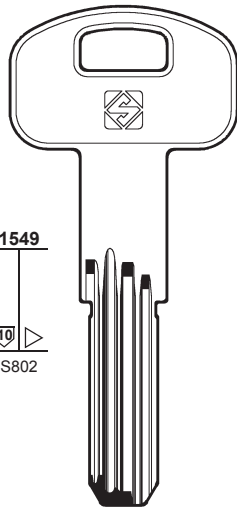

SCM1R  
K2

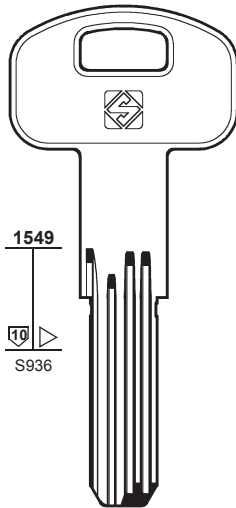

SCM2  
K1

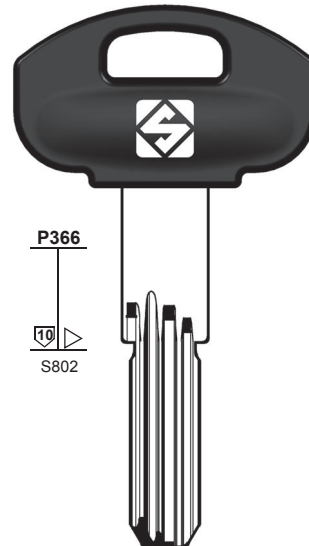

SCM3RP  
K2

PER:  
FOR:

### SECURIT

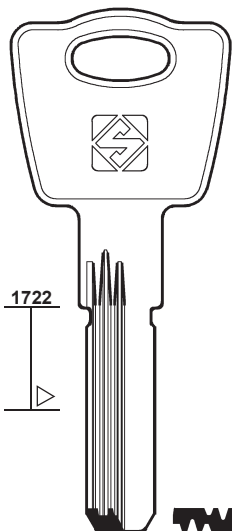

SCT1R



### SECURITAL

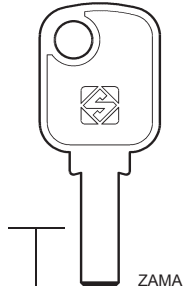

S39  
S612  
S760  
S761  
S1265  
S1391

SCU1



KYR

### SEGAL

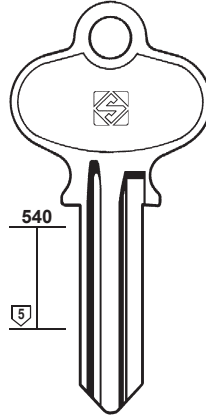

SL1  
A  
K9

HUDSON - READING

### SEKUR

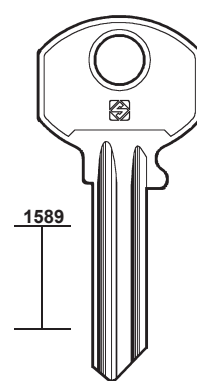

SKR1



# 168

PER / FOR

**SELECT** (FR)

**SELMACH** (RU)

**SEMED** (FR)

👁️ JIS (110)

**SEN** (DE)

👁️ KfV (116)

**SERITAL** (IT)

👁️ PREFER (157)

**SERRALLER** (ES)

👁️ AGA (11)

**SES** (FR)

👁️ MELSMETAL (136)

**SESA** (FR)

👁️ RONIS (161)

**SEZAN** (TW)

👁️ YETI (218-219)

**SFB** (SE)

**SHANGHAI** (CN)

CINA

+ 👁️ CINA (54)

**SHAW** (GB)

+ 👁️ HTV (103)

**SHILUTE** (RU)

**SHOWA** (JP)

+ 👁️ SARGENT (165)

PER:  
FOR:

## SELECT

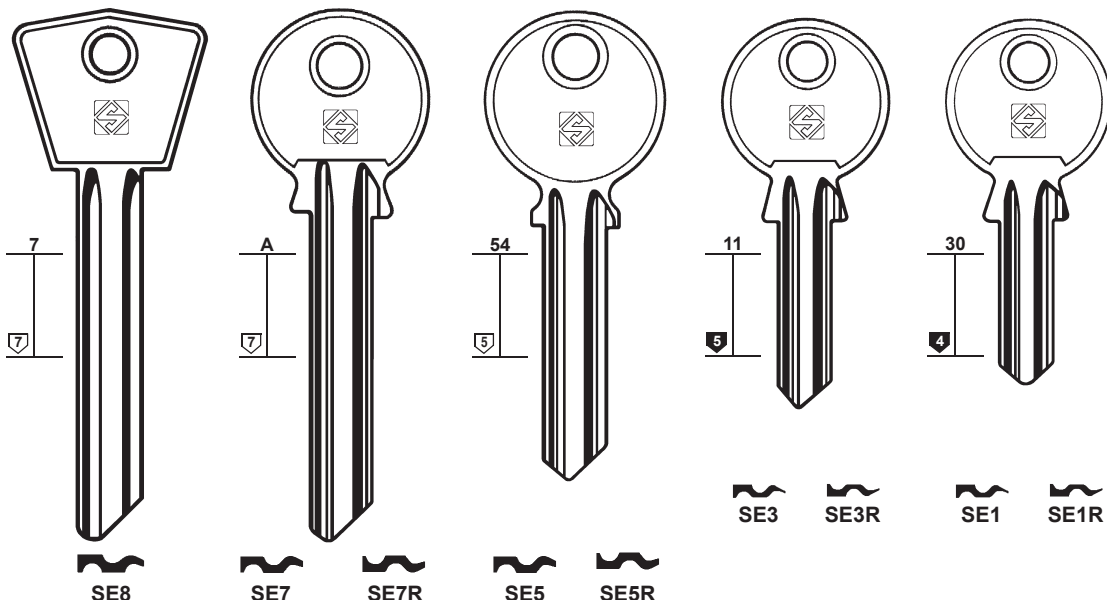

PER:  
FOR:

## SELMACH

## SFB

## SHANGHAI

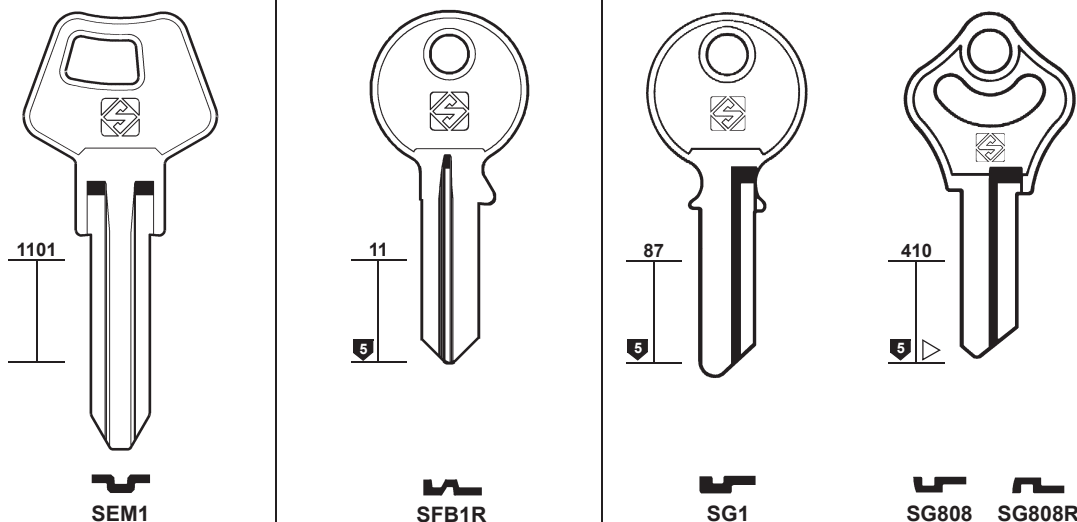

PER:  
FOR:

## SHAW

## SHILUTE

## SHOWA

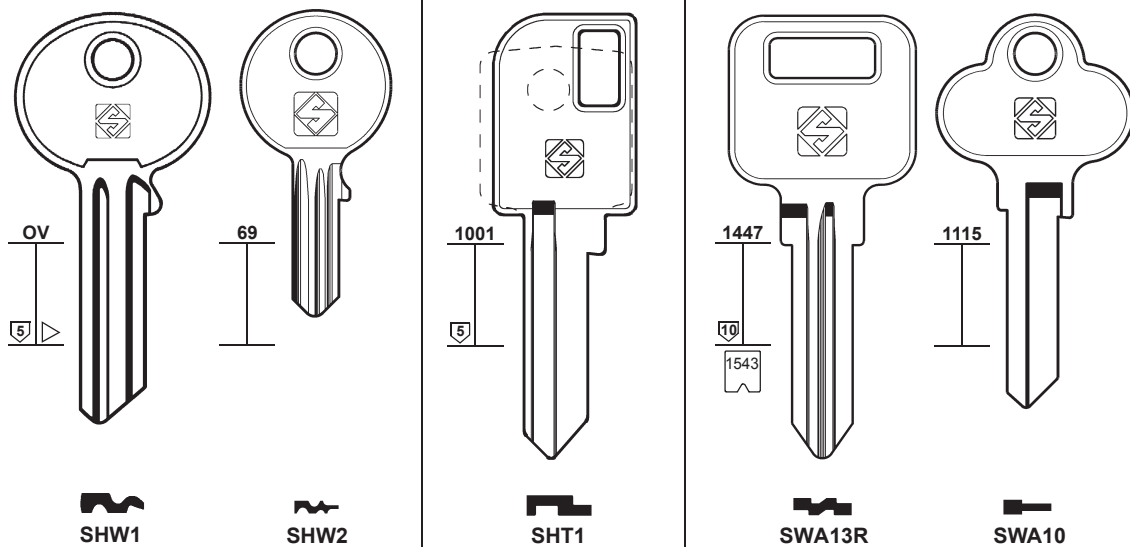

PER: FOR:	SHOWA	SIAM	SIDLEEN
	<p>SWA1 SWA2R SWA3R SWA4R SWA5R SWA6R SWA7R SWA8 SWA9R</p> <p>1-2-3-4-5-6-7-8-9</p>	<p>SIA1R</p>	<p>SD1</p> <p>EXCEL</p>



**169**

- PER / FOR**
- SHOWA (JP)**
    - + SARGENT (165)
  - SIAM (DZ)**
    - + CITY (58)
    - + SIMECA (170)
    - + ZENITH (222)
  - SICCAF (IT)**
    - + SEAT (167)
  - SICMA (FR)**
    - + ZENITH (222)
  - SIDLEEN (GB)**
    - BANHAM
    - EXCEL
    - REGENT
    - RUFFLER & DEITH
    - RUFFLER & WALKER
  - SIEBAU (DE)**
    - + CES (47)
    - + TOK-WINKHAUS (186)
  - SIGENIA (DE)**
    - + POS (155)
  - SIGMA (PL)**
  - SIL (PT)**
  - SILCA (IT)**
    - + P.C. CORTELLEZZI (154)
  - SILVANA (BR)**
  - SIMATIC (CH)**
    - + SIMECA (170)

PER: FOR:	SIDLEEN	SIGMA	SIL
	<p>SD2 SD3T</p> <p>BANHAM RUFFLER &amp; DEITH RUFFLER &amp; WALKER REGENT</p>	<p>SGM1</p>	<p>SIL1 SIL1R</p>

PER: FOR:	SILCA	SILVANA
	<p>PC12T PC15T SLC1TP SLC2TP SLC3T</p>	<p>SVN1 SVN2</p>



# 170

**PER / FOR****SIMECA (CH)**CAB  
GIUSSANI  
GUTLER  
JPM  
KATE  
ORBA  
SIAM  
SIMATIC**SINA (IT)**

ZANI (220)

**SINJET (DE)**

DOM (68)

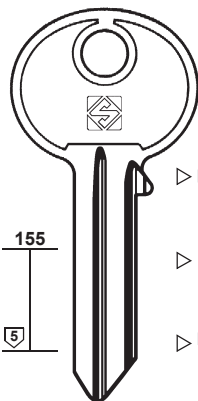
**SIS (IT)**FEL  
LASBOLAGET  
PICARDIE  
ZENITHPER:  
FOR:**SIMECA**155  
5

SM10R SM14R

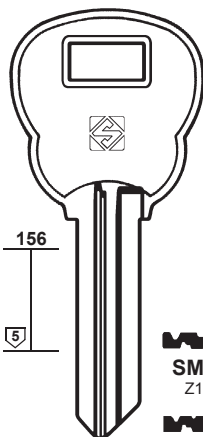
156  
5

SM9R SM9 40

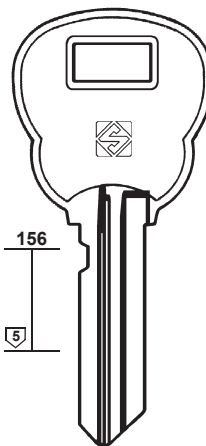
156  
5

SM16

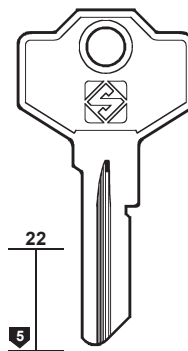
22  
5  
207

SM1

..... 3001-3480  
..... 9001-9741  
G ..... 0-480  
G ..... 3001-3480  
G ..... 9001-9741CAB  
GIUSSANIGUTLER - KATE  
ORBA - SIAM - SIMATIC

JPM

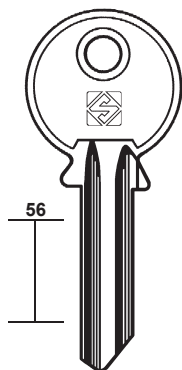
PER:  
FOR:**SIMECA**

56

SM15

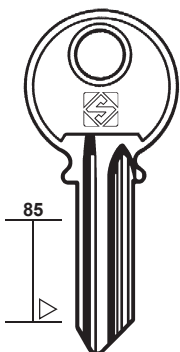

85

SM13

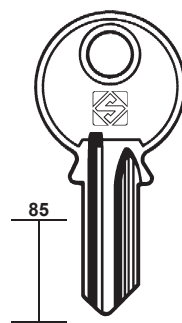

85

SM12

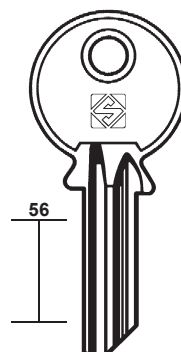

56

SM11

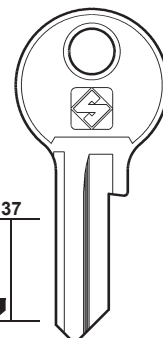
37  
5

ZENITH

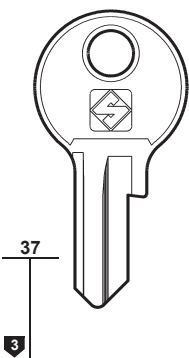
PER:  
FOR:**SIS (IT)**37  
3

SS9

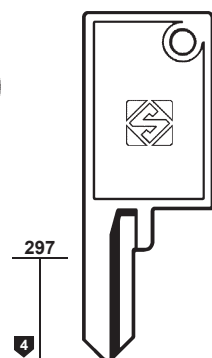
297  
4

SS6

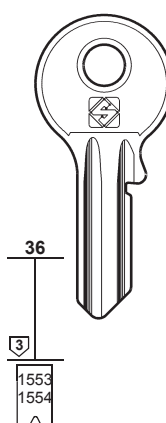
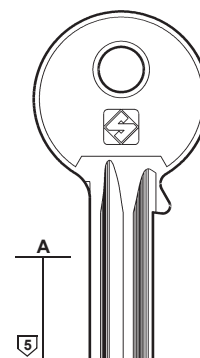
36  
3  
1553  
1554SS14 SS14R  
... 7654321A  
5

SS12

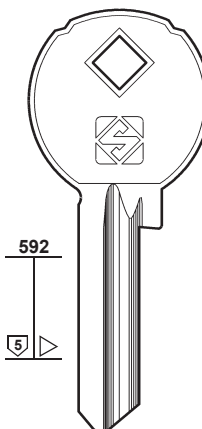
592  
5

SS7 SS7R



FEL



PICARDIE

LASBOLAGET

PER:  
FOR:

SIS (IT)

SIS (PT)



171

PER / FOR

SIS (IT)

SIS (PT)

SISO (DK)

- + CAS-CISMA (45)
- + EVERGOOD (80)
- + OJMAR (147)

SJL (RU)

SKILLMAN (US)  
CORBIN (61)

SKMZ (UA)

SLAYMAKER (US)  
SARGENT & GREENLEAF

SOBINCO (BE)  
+ CAS-CISMA (45)  
+ SOFI-SONAFI (172)

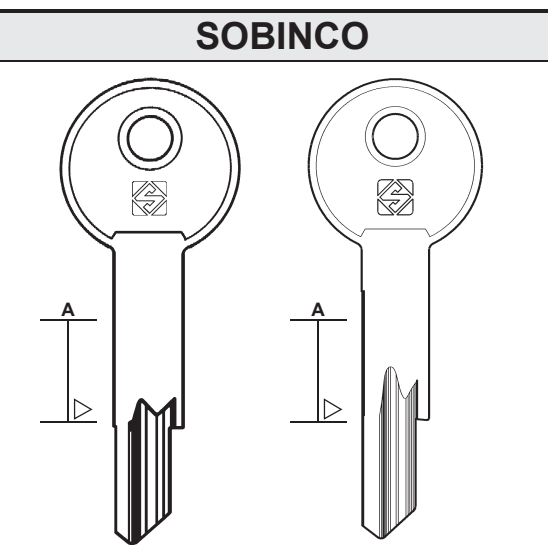
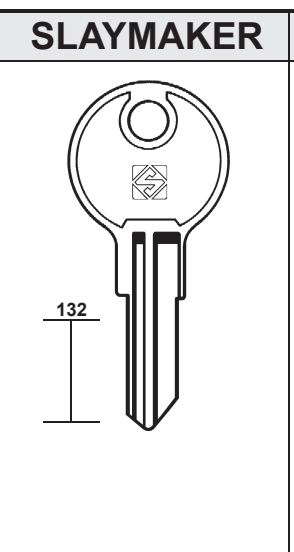
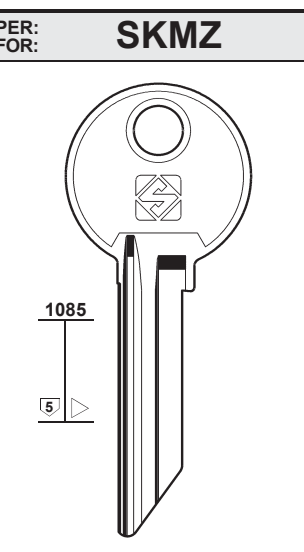
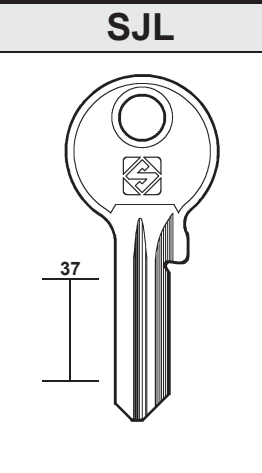
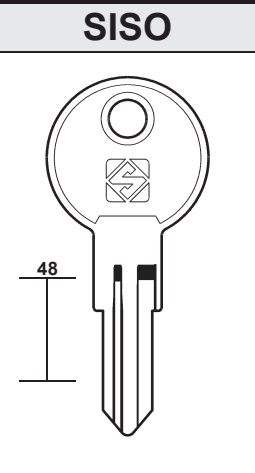
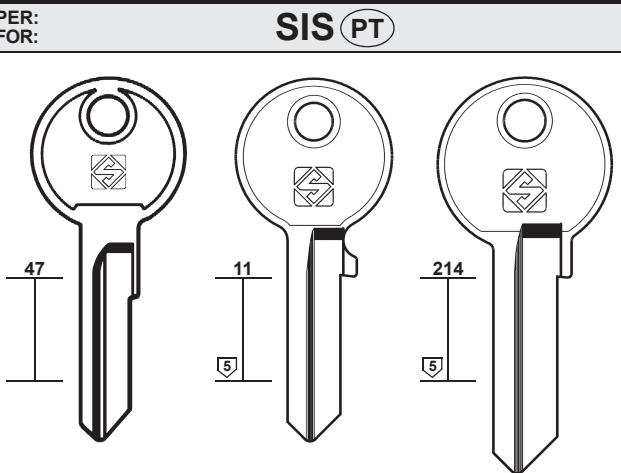
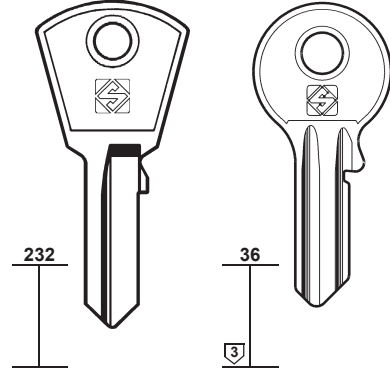
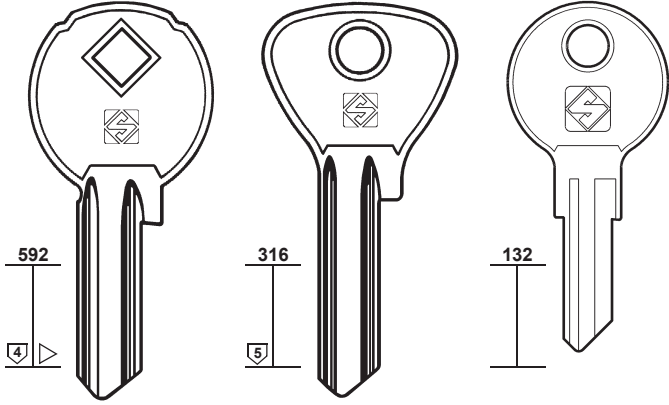

SARGENT & GREENLEAF



# 172

PER / FOR

**SOBINCO** (BE)  
+ **SOFI-SONAFI** (172)

**SOF** (FR)  
 **GLOBE** (97)

**SOFER** (PT)

**SOFI-SONAFI** (PT)  
CHAVO  
SOBINCO

**SOFRANQ** (FR)  
 **RONIS** (161)

**SOLER** (ES)

**SOLEX** (CN)

**SOLID** (ZA)  
 **CES** (47)

**SOLOR** (FR)  
 **RONIS** (161)

**SONICO** (BG)

PER: FOR:	SOBINCO	SOFER	SOFI-SONAFI
	 1  642 5 2278	 448	 284 5
	 SN1	 SN2	 SN5R
	 SN1R	 SN2R	 SN5R
		 SOF1	 S1
		 SOF1R	 S1R
			CHAVO

PER: FOR:	SOFI-SONAFI				
	 355 5	 355 4	 325 5	 597 4	 317 4
	 SI4	 SI4R	 SI6R	 SI3R	 SI5R
				 SI2R	
					SOBINCO

PER: FOR:	SOLER	SOLEX	SONICO	
	 1308	 1385	 1373 5	 1373 10
	 SLR1	 SLX1	 SNC1	 SNC2
		 SNC2R	 SNC3	

PER:  
FOR:

### SOPRANO

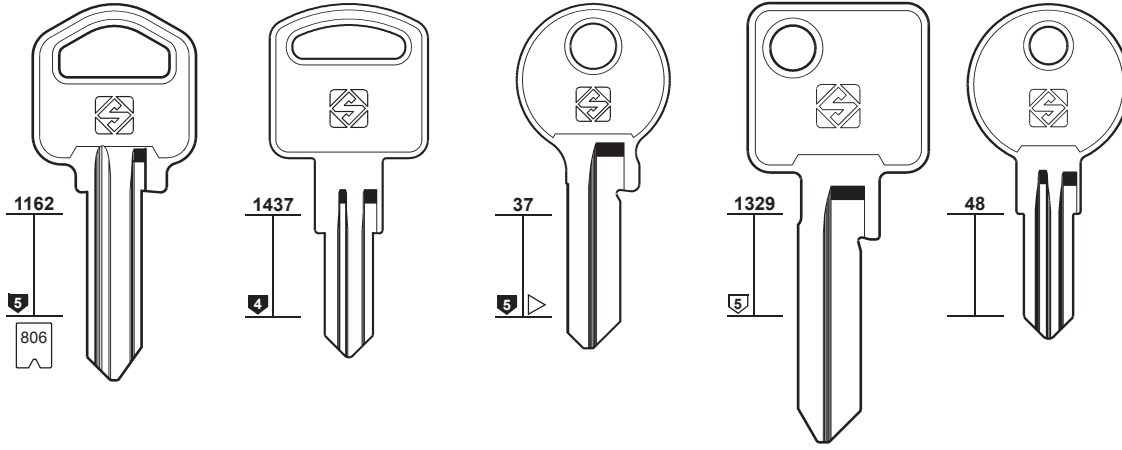

SOP1

1-2-3-4-5-6-7-8-9



SOP2



SOP10



SOP11



SOP12



# 173

PER / FOR

SOPRANO (BR)

SOS (FR)

- + CITY (58)
- + GABON (93)
- + MING-TAY (140)
- + TESA (181)
- + YALE (215)

PER:  
FOR:

### SOPRANO

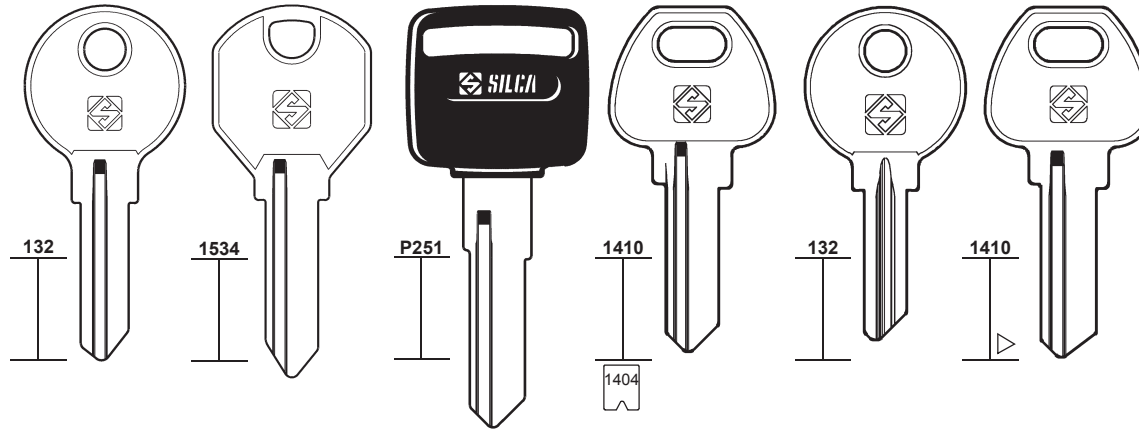

SOP15R



SOP13R



SOP14RP



SOP16R

1-2-3-4-5



SOP17R



SOP18R

PER:  
FOR:

### SOS

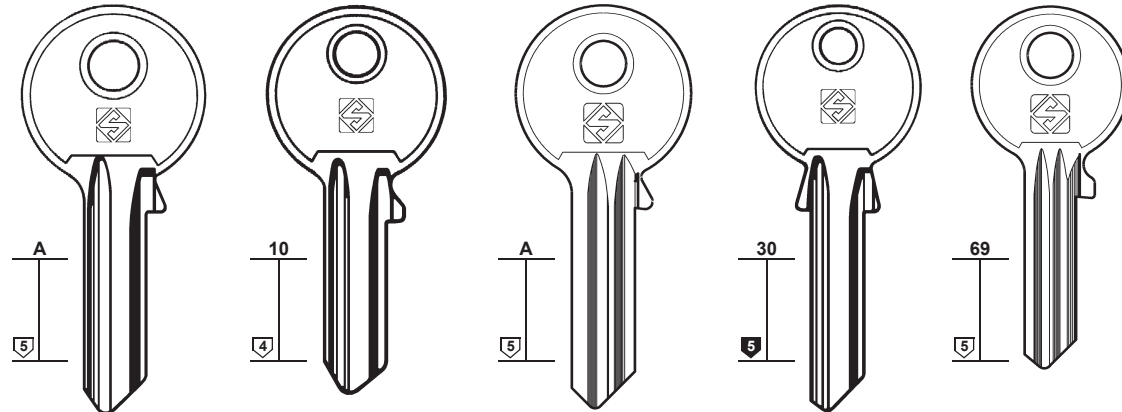

SO4



SO7



SO5



SO8R



SO6



SO9





# 174

### PER / FOR

#### SOS (FR)

- + CITY (58)
- + GABON (93)
- + MING-TAY (140)
- + TESA (181)
- + YALE (215)

#### SOUTHCO (GB)

- + YALE (213)

#### SP (FR)

- + FTH (92)
- + MUL.T.LOCK (144)

#### SPEEDAL (IT)

- + CES (48)

#### SPIDER (IL)

- + CAVERS
- + CODKEY

#### SQUIRE & SONS (GB)

#### SS (DE)

- + CES (47)

#### STA-LOCK (GB)

- + SECURE (167)

#### STAM (BR)

PER:  
FOR:

### SOS

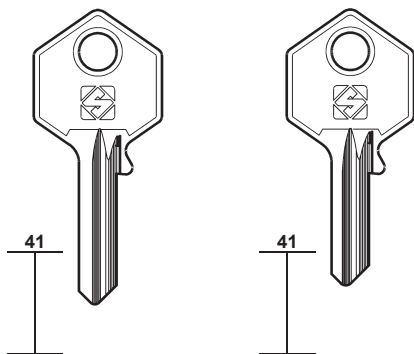

**SO10R**

**SO11R**



mm 25

### SPIDER

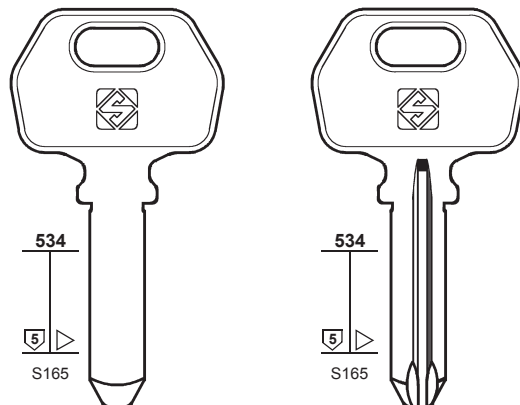

**SPR1**

**SPR2**



**CODKEY**



**CAVERS**

PER:  
FOR:

### SQUIRE & SONS

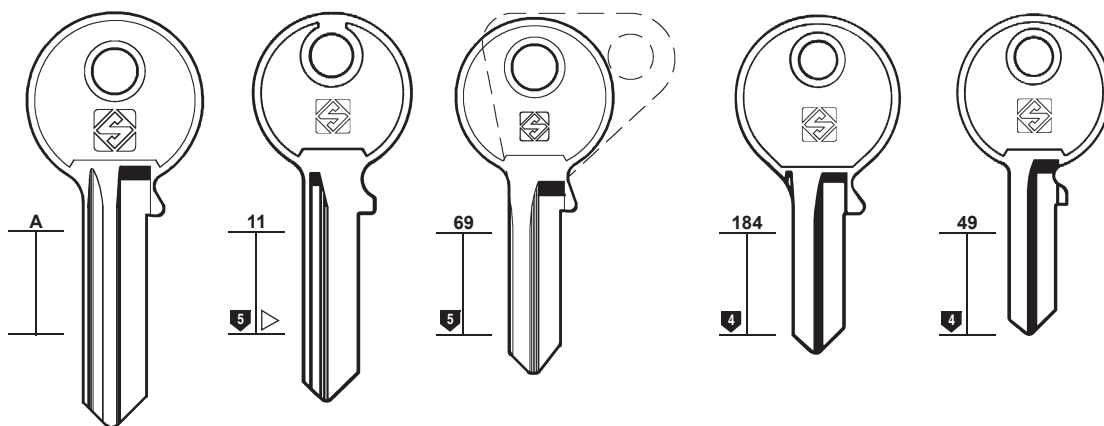

**SQ4R**

**SQ3R**

**SQ5**

**SQ1**

**SQ2**



PER:  
FOR:

### SQUIRE & SONS

### STAM

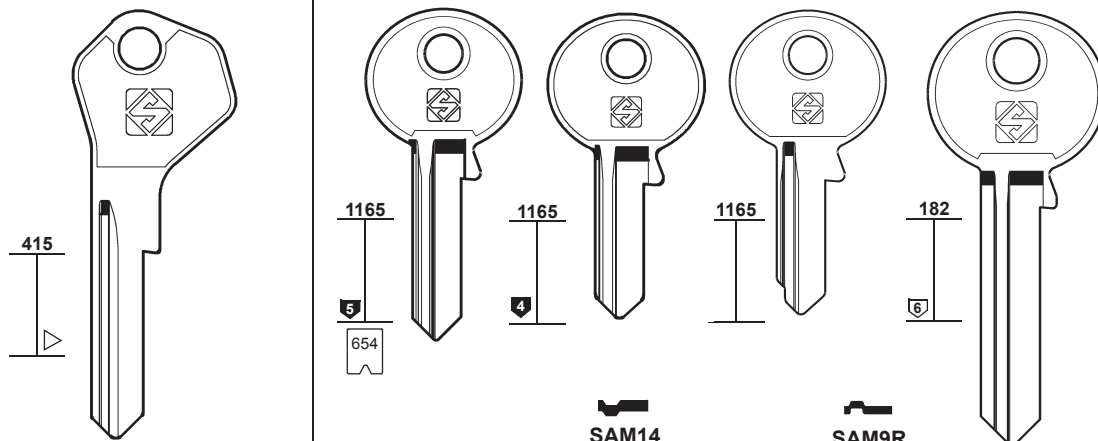

**SQ6R**

**SAM14**

**SAM9R**

**SAM1**

**SAM1R**

**SAM15R**

**SAM13**

**SAM13R**

**SAM4**

..... 1-2-3-4-5-6-7-8



PER:  
FOR:

### STAM

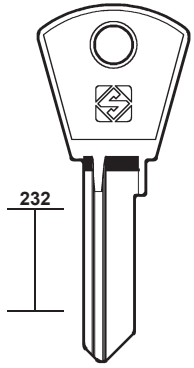

 SAM6

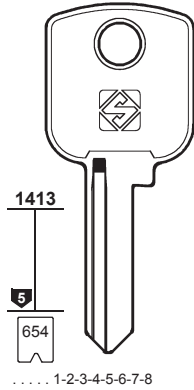

 SAM12R

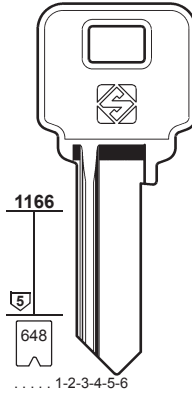

 SAM2

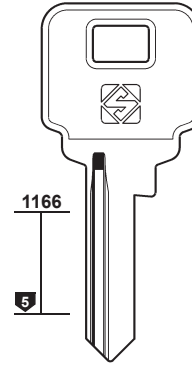

 SAM3R



# 175

PER / FOR

STAM (BR)

STANDARD (DE)

 CISA (55)

STANOFDRO (CN)

STAR (JP)

+  ISEO (108)

PER:  
FOR:

### STAM

### STANOFDRO

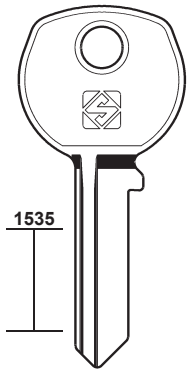

 SAM10

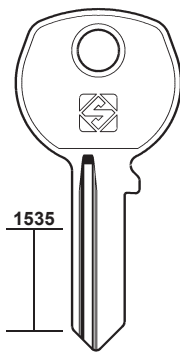

 SAM11R

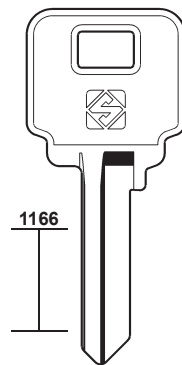

 SAM8

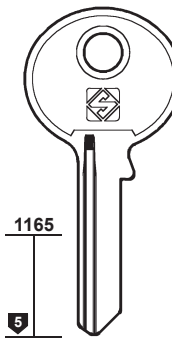

 SFD1R

PER:  
FOR:

### STAR

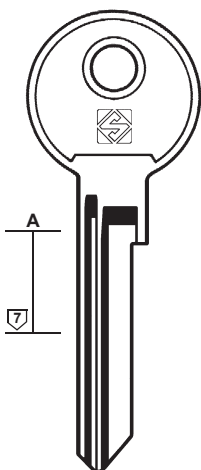

 STA2    STA2R

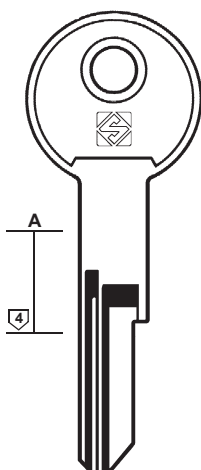

 STA1    STA1R

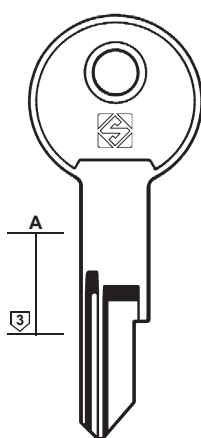

 STA3    STA3R

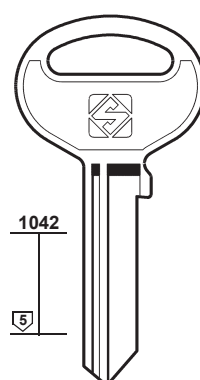

 STA10    STA10R

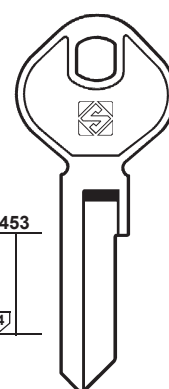

 STA9R

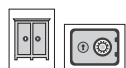



# 176

### PER / FOR

#### STAR (JP)

GS  
IJ  
TEC  
+ ISEO (108)

#### STARLET (DE)

GERA

#### STARRY (NL)

#### STEELCASE (US)

CHICAGO (52)  
HUWIL (104)

#### STEIGA (DE)

DOM (70)

#### STEM (FR)

ABUS (9)

#### STIQAM (TN)

CAS-CISMA (45)

#### STORWALL (GB)

#### STRAFOR (GB)

HUWIL (104)  
LAS (121)  
RONIS (161-162)

#### STREBOR (GB)

#### STREMLER (FR)

BRICARD (39)  
CAS-CISMA (45)  
CORBIN (60)  
RONIS (161)

PER:  
FOR:

## STAR

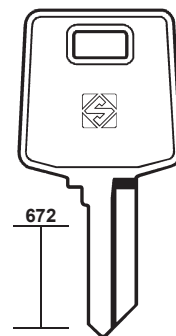
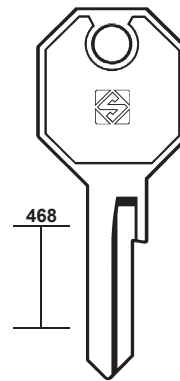
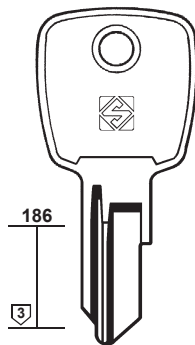
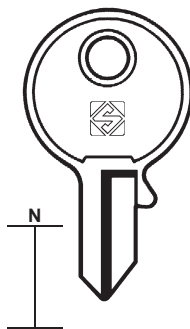
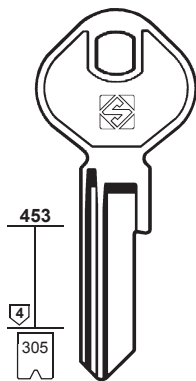

STA4



STA4R  
K... 1-1600



STA8



STA8R



STA5



STA11R



STA6



STA6R



STA7



IJ - TEC



GS



GS

PER:  
FOR:

## STARLET

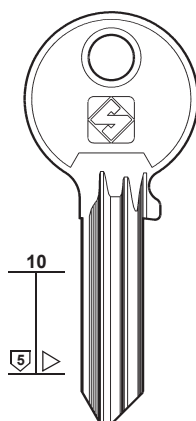

STL1R

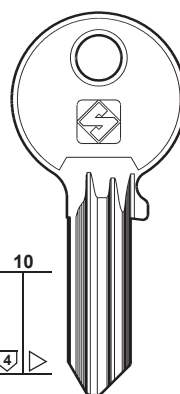

STL2R

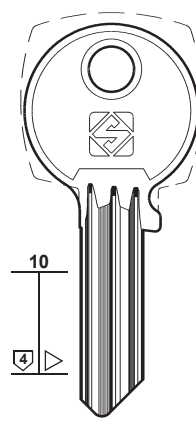

STL3

GERA

## STARRY

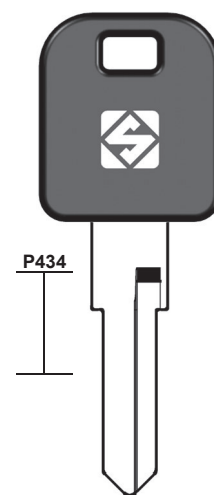

STY1P



PER:  
FOR:

## STORWALL

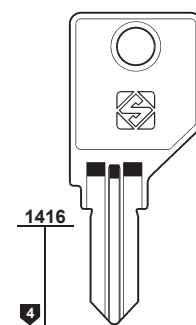

SWL1

## STREBOR

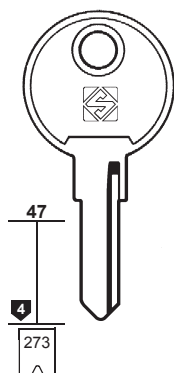

STR5  
F... 402-480



STR5R  
F... 503-581

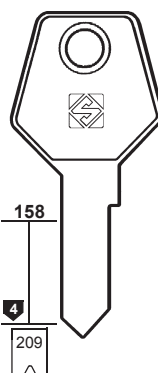

STR3  
S... 1-70

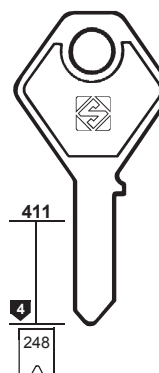

STR4  
RR... 502-579



STR4R  
RR... 502-579

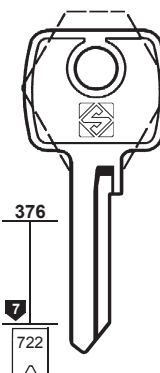

STR6  
MT... 1-989



PER:  
FOR:

### STS

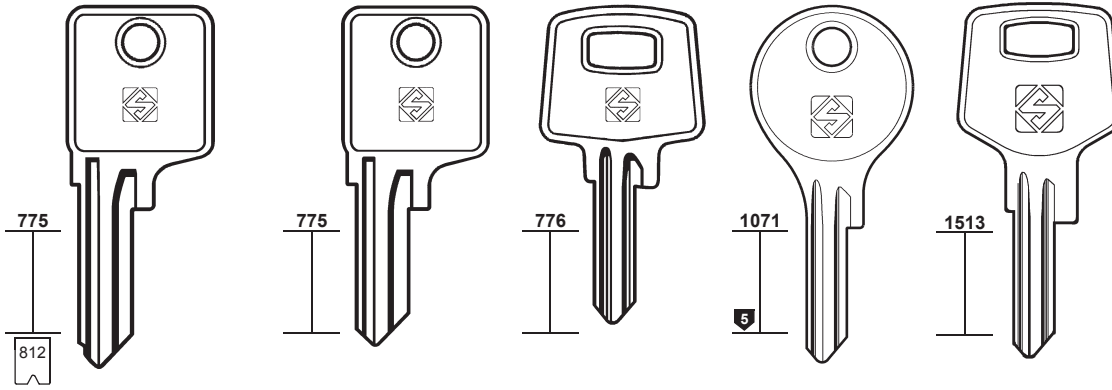

(625) 0-1-2-3-4-5



ALSO



BTV

ARFE



# 177

PER / FOR

**STS (ES)**

ALSO  
ARFE  
BTV  
TESA

- + ARFE (19)
- + DOM (68-71)
- + ELCA (76)
- + PICARDIE (155)
- + TESA (181-182)

**STUBLINA (RS)**

**STUMPF (DE)**

- + OJMAR (147)

**STUV (DE)**

- + CES (47)
- + DOM (70)
- + GEVY (95)
- + MLM (141)

PER:  
FOR:

### STS

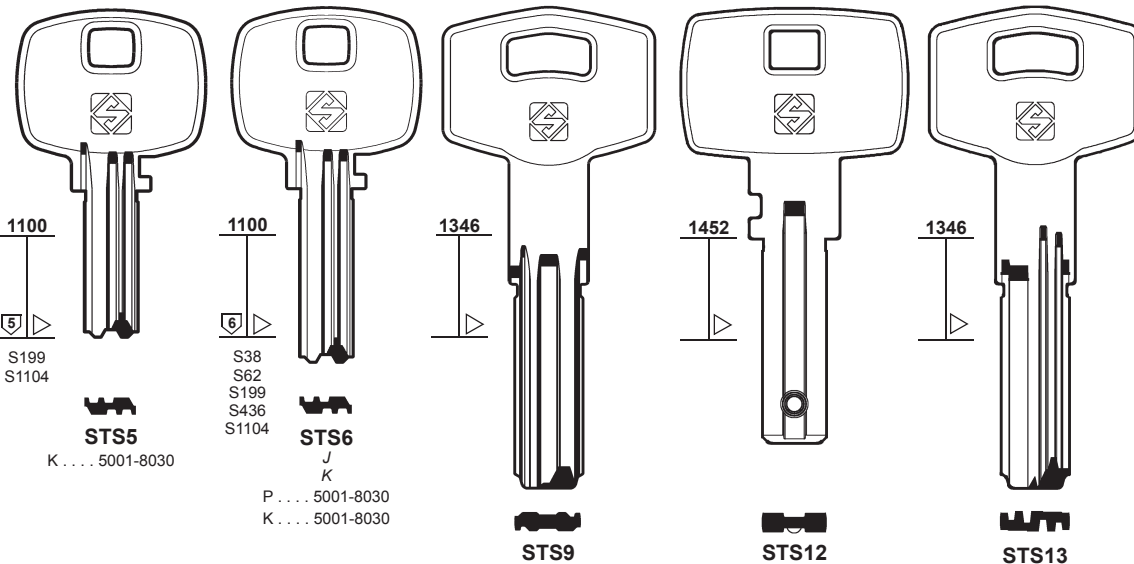

S199  
S1104



**STS5**

K . . . . . 5001-8030

S38  
S62  
S199  
S436  
S1104



**STS6**

J  
K  
P . . . . . 5001-8030  
K . . . . . 5001-8030



**STS9**



**STS12**



**STS13**



TESA

PER:  
FOR:

### STUBLINA

### STUMPF

### STUV

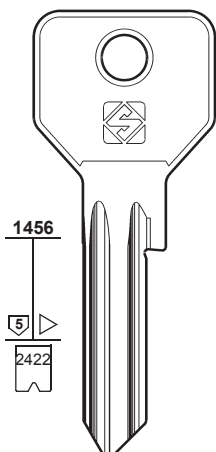

**STN1**



**STN1R**

. . . . . 12345678

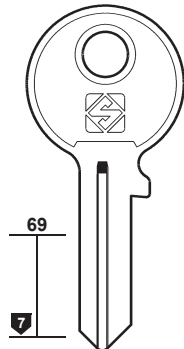

**STF1**



**STF1R**

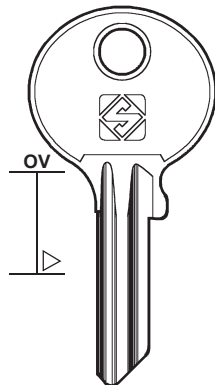

**SV3**



**SV3R**



**SV7**





# 178

### PER / FOR

#### STUV (DE)

DOM  
MLM

- + CES (47)
- + DOM (69)
- + GEVY (95)
- + MLM (141)

#### STV (IT)

- + OMIV (149)
- + GEVY (95)

#### SÜDMETALL (DE)

#### SUF (FR)

- + FTH (91)

#### SUKI (JP)

- + FLORA (90)

#### SUL (IT)

- + CORBIN (60)
- + P.C. CORTELLEZZI (153)

#### SUNSUI (TW)

#### SUPER (TW)

#### SUREX (FR)

- ATLAS
- EUROP
- MATTEY
- + GABON (93)
- + YALE (213)

#### SURFINOR (FR)

- + FICHET (89)

#### SUYOKA (JP)

- + AGA (11)

#### SWAN (IT)

- + YETI (218-219)

PER:  
FOR:

## STUV

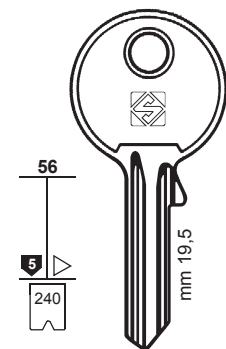

2F ... 201-278 1F ... 201-278  
1F ... Z 201-278 1F ... Z 201-278  
1F ... X 201-278 1F ... X 201-278



SV2R

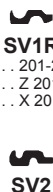

SV2

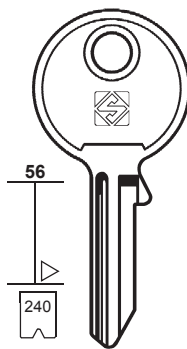

2F ... 201-278 2F ... 201-278  
1F ... Z 201-278 1F ... Z 201-278  
1F ... X 201-278 1F ... X 201-278



SV4



SV4R

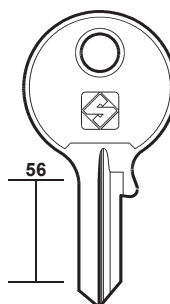

SV6R  
1FP

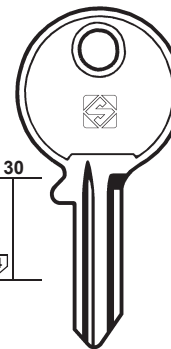

YM18



MLM - DOM



## SÜDMETALL

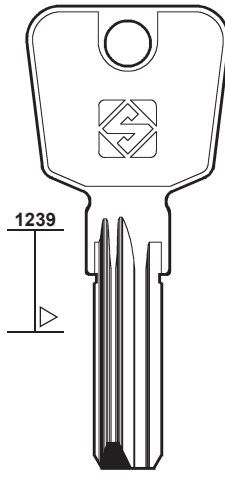

SDT1R



PER:  
FOR:

## SUNSUI

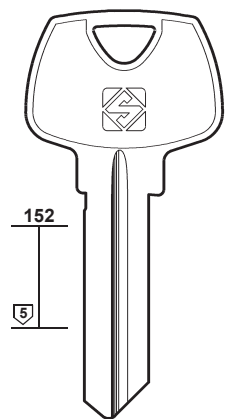

SU1R

## SUPER

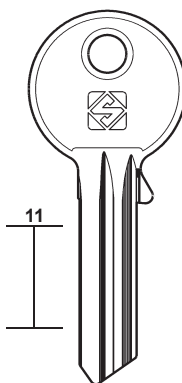

SPU1R

## SUREX

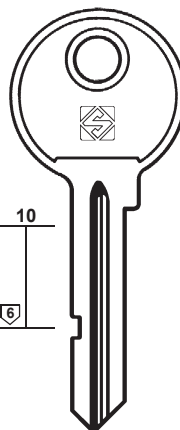

SR8

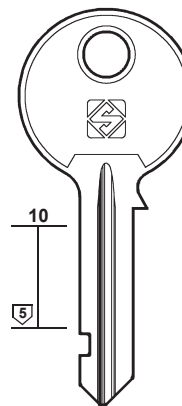

SR7

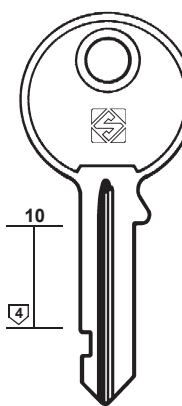

SR6

PER:  
FOR:

## SUREX

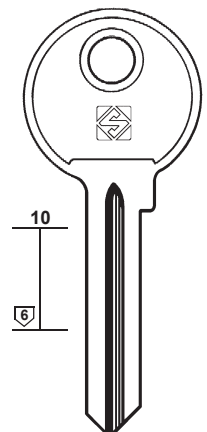

SR10R

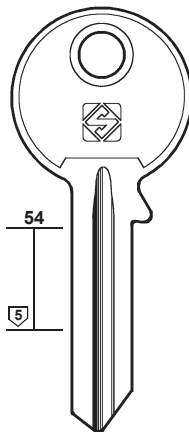

SR4

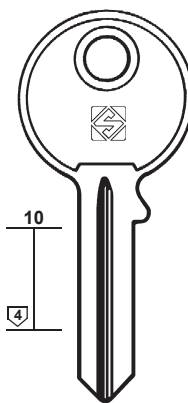

SR11R

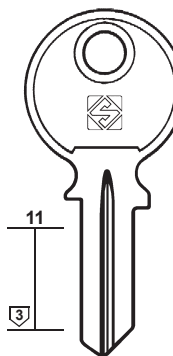

SR2 SR2R

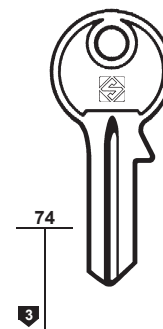

SR9R



ATLAS



ATLAS - EUROP  
MATTEY

PER:  
FOR: **SWEDA**

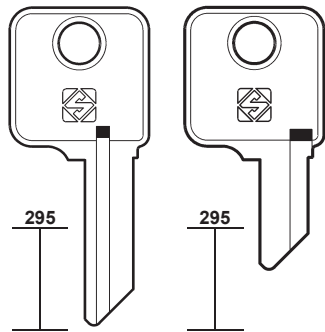

**SW1R**  
Z

**SW3**  
L

**SW2**  
X



**TALLIN**

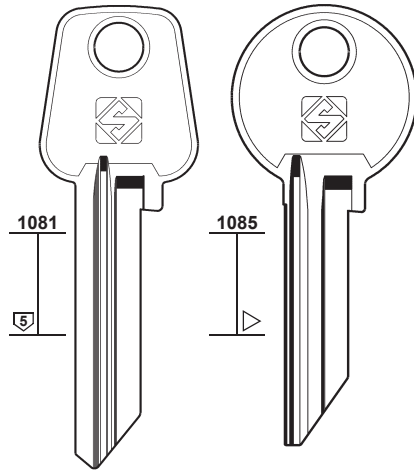

**BLT1R**

**TLN1**

**TAMPALINI**

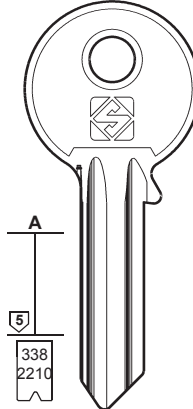

**TP1 TP1R**  
..... 123456  
..... 12345

**BALLY - K+K - SAB - TF**



**179**

**PER / FOR**

**SWEDA (IT)**  
+ PREFER (157)  
+ PRIM (158)

**SWISSTAC (DE)**  
 DOM (68)

**T-KEY (CN)**  
 BALING LOCKS (30)

**TACO (USA)**  
 SCHLAGE (166)

**TALLIN (EE)**

**TAMPALINI (IT)**  
BALLY  
K+K  
SAB  
TF  
+ MORI E. (142)

**TANLOCKS (ZA)**  
 LÄSBOLAGET (122)

**TARONI (IT)**

PER:  
FOR: **TAMPALINI**

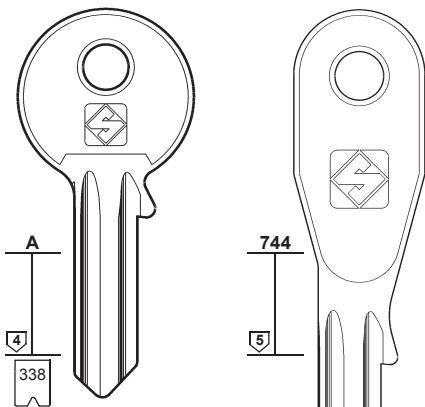

**TP3**

**TP2 TP2R**  
..... 1-2-3-4-5-6

**TARONI**

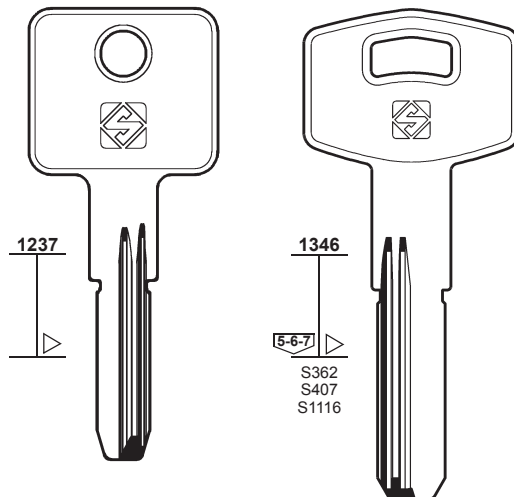

**TAR21**

**TAR16 TAR16R**  
S362  
S407  
S1116

PER:  
FOR: **TARONI**

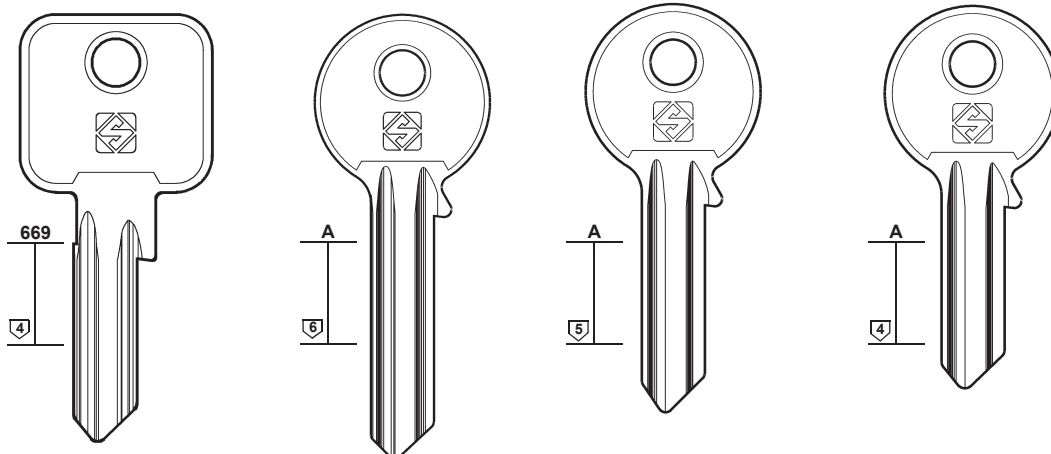

**TAR26**

**TAR11**

**TAR4**

**TAR5 TAR9**

**TAR11R**

**TAR4R**

**TAR5R TAR9R**



180

PER / FOR

TARONI (IT)

TARZEN (TW)

TAS (DE)  
BIBERING  
TÜRSCHLOSS

TAUB (ES)  
ZANETTI A. (220)

TAV (FR)  
RONIS (162)

TAYLOR (US)

TEC (FR)  
STAR (176)

TECON (ES)

TECHNAL (DE)  
CAS-CISMA (45)  
TESA (181)

TECNOR (FR)  
FICHET (89)

TECSESA (ES)

TEEN HAAF (NL)  
KIFERM (117)

PER:  
FOR:

TARONI

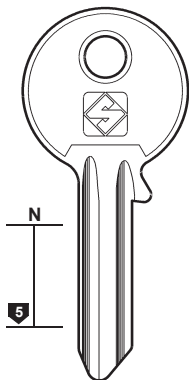

TAR8R

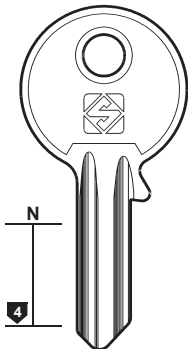

TAR3R

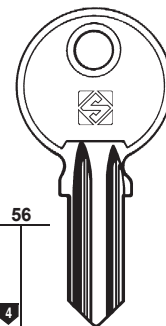

TAR6R

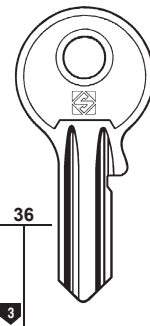

TAR10R



PER:  
FOR:

TARONI

TARZEN

TAS

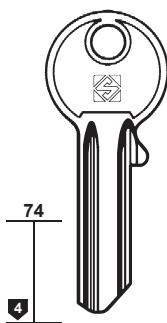

TAR1R

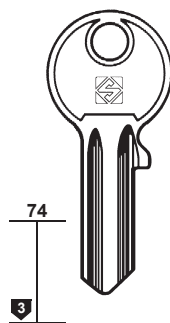

TAR2R



TAR7R

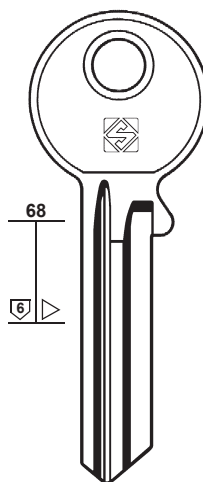

TZN1

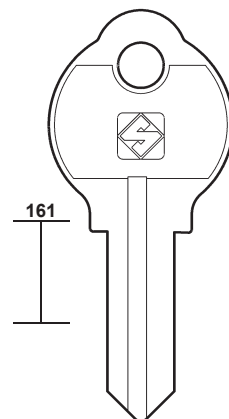

TUS1



TUS1R



TUS2R

BIBERING - TÜRSCHLOSS

PER:  
FOR:

TAYLOR

TECON

TECSESA

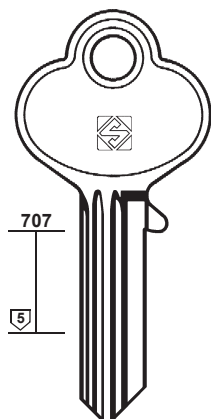

TY1

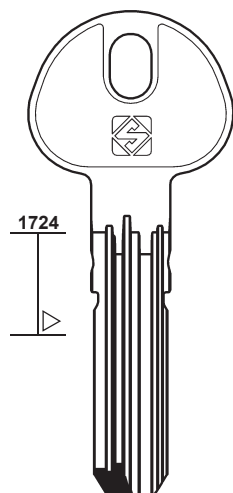

TEN1

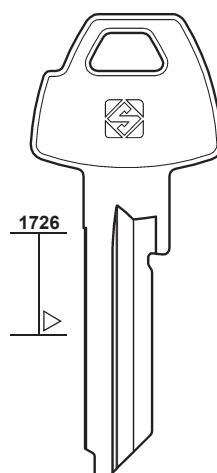

TEN2R

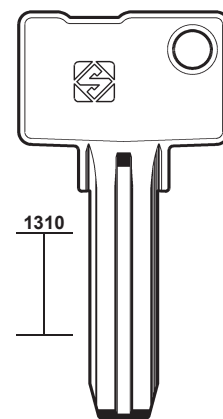

TEC1



PER:  
FOR:

### TEGASI

### TEICOCIL

### TEKA

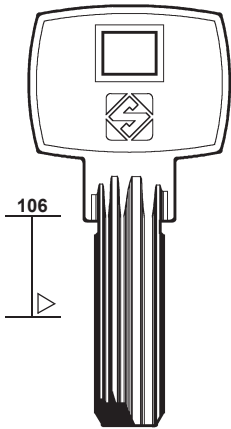

**TGS1R**

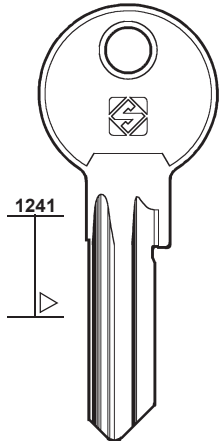

**TCL1**

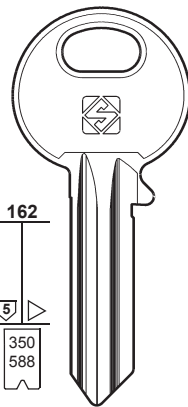

**ASS6**

20201  
..... 0-1-2-3-4-5-6-7-8-9-A-B-C  
..... D-0-1-2-3-4-5-6-7-8-9-A-B-C

**ASS6R**

20301  
..... 0-1-2-3-4-5-6-7-8-9-A-B-C  
..... D-0-1-2-3-4-5-6-7-8-9-A-B-C

ASSA

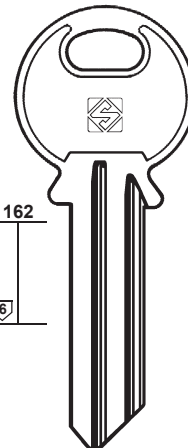

**TK3**

20902

**TK3R**

20802

ERICSSON

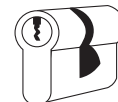

# 181

PER / FOR

**TEGASI** (GR)

**TEICOCIL** (PT)

**TEKA** (SE)

ASSA  
ERICSSON  
ERMEX  
LM

+ ASSA (21)

**TELFORD** (GB)

L & F (128)

**TEM** (ES)

IFAM (106)

**TERCA** (ES)

AGA (11)

**TESA** (ES)

ESAFE  
GAINSBOROUGH  
KAWE  
METALUX  
NINO  
SOS  
STS  
TECHNAL  
+ ELCA (76)

PER:  
FOR:

### TEKA

### TESA

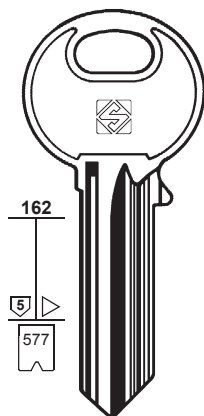

**ASSA**  
**ERMEX**  
**LM**



**TK1**

20004

.....  
0123456789ABCEFG



**TK1R**

20102

**ASSA**  
**ERMEX**  
**LM**



**TK4**

21701



**TK4R**

21601



**TK2**

21001



**TK2R**

21101

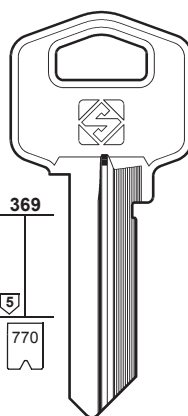

**TE1**



**TE1R**

..... (TE-5)  
0-9-8-7-6-5-4-3-2-1

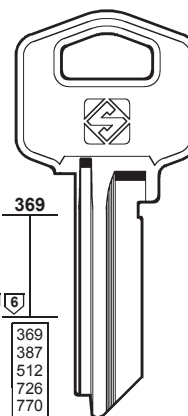

369

5 6

387

512

726

770



**TE2 ESAFE**

..... (TE-5) 0987654321

..... 0123456789

..... 123456789

..... A/Z 123456789



**TE3**

..... 123456789

..... A/Z 123456789



**TE6**

..... 0987654321

GAINSBOROUGH - KAWE  
METALUX - NINO - SOS - TECHNAL

PER:  
FOR:

### TESA

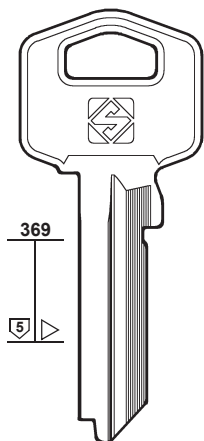

**TE2X**

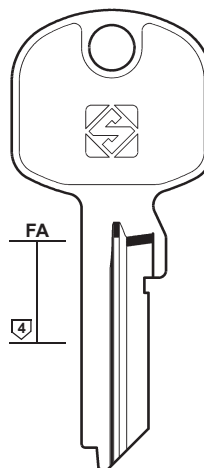

**TE8XFA**

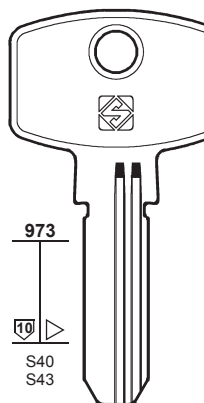

**TE4**

T-10



**TE4R**

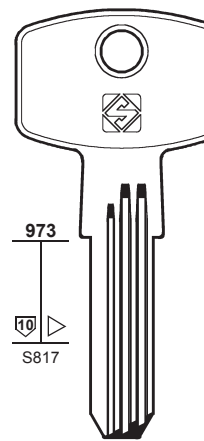

**TE16**

T-10P



STS





# 182

### PER / FOR

**TESA** (ES)

KALE  
STS  
VIRO  
+ ELCA (76)

**TESIO** (IT)

CORBIN (61)

**TESTA** (IT)

CAS-CISMA (45)

**TF** (IT)

TAMPALINI (179)

**TH** (DE)

H.R.S.  
TRUMPF

**THIRARD** (FR)

**THÖMEE** (DE)

CES (50-51)

**THÖNE** (DE)

CORBIN (60)

**TICINO** (IT)

BERTOLOTTI

**TIEFENTHAL** (DE)

CISA (55)  
 ELZETT (76)  
 EMR (77)  
 GTV (100)  
 JOWIL (110)

**TIFON** (TW)

**TIGRIS** (GB)

**TIK** (GB)

**TILANCO** (IT)

PER:  
FOR:

## TESA

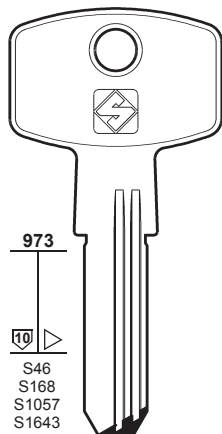

EC5



KALE - STS - VIRO

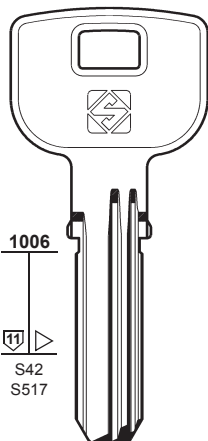

TE5

T-80



TE9

T80/SC



STS

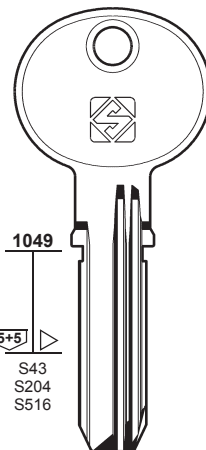

TE7

T-60



STS

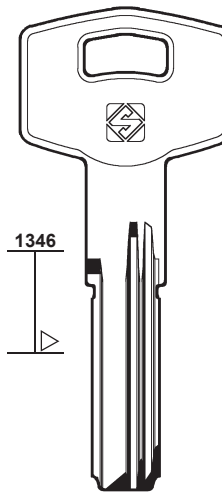

TE19



PER:  
FOR:

### TH

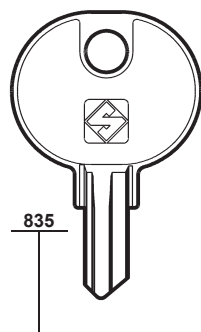

THA1

H.R.S. - TRUMPF

### THIRARD

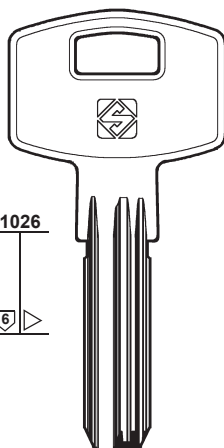

THR1



### TICINO

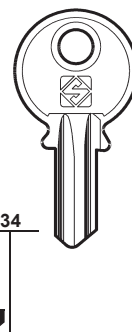

TC1



TC1R



BERTOLOTTI

### TIFON

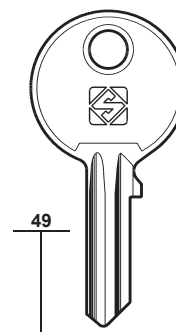

TFN1



TFN2

PER:  
FOR:

### TIGRIS

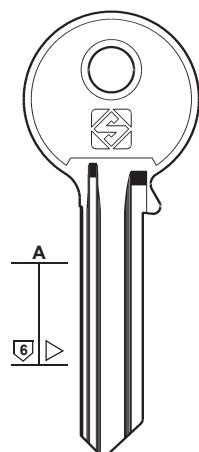

TG1

### TIK

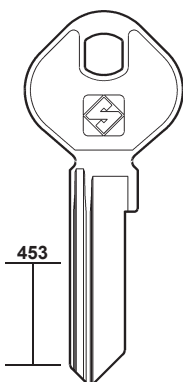

TI1

### TILANCO

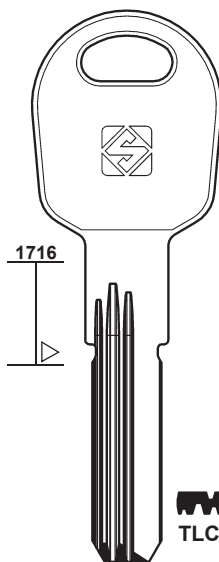

TLC1R



### TITAN

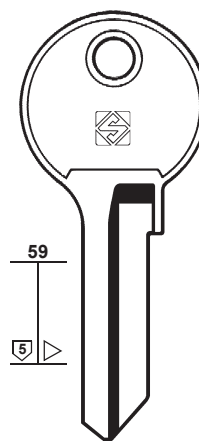

TN1



TN1R

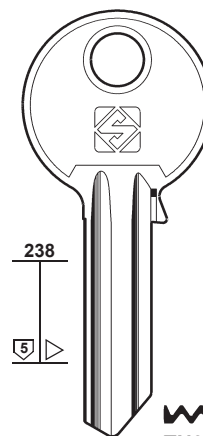

TN2



TN2R



TN5



TN8R



TN37R



PER:  
FOR:

### TITAN

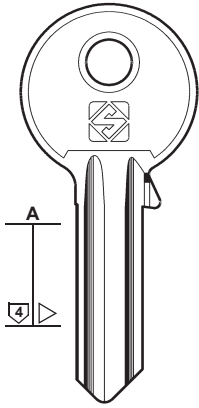

TN16

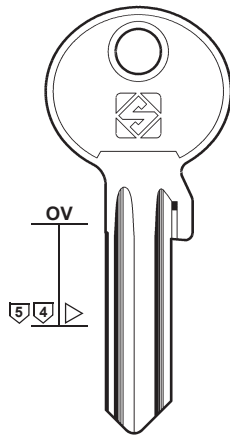

TN16X

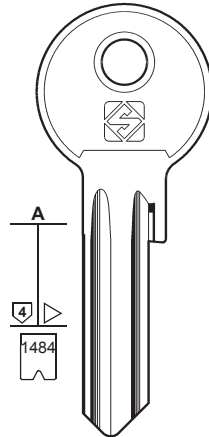

TN16XA TN39

... 123456789

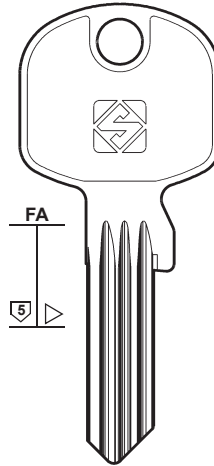

TN19R TN23

PICARDIE



# 183

PER / FOR

TITAN (SI)  
EMKA  
FTH  
GIUSSANI  
LAMA  
PICARDIE  
VACHETTE

TITAN LOCK (US)  
KWIKSET

PER:  
FOR:

### TITAN

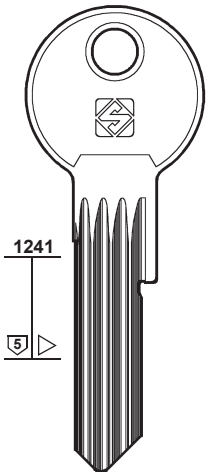

TN50

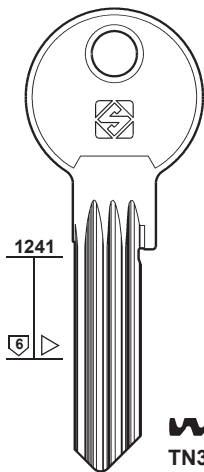

TN20

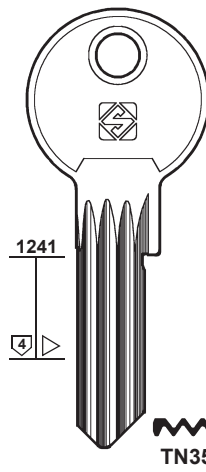

TN20R

TN20R



TN36



TN35

TN36R

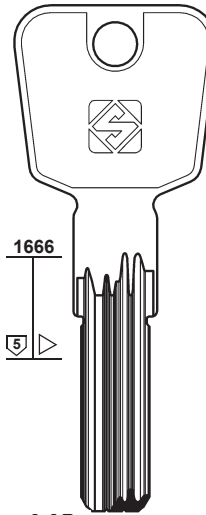

TN51

TN32

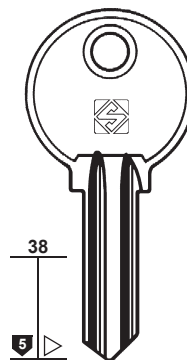

TN7  
EMKA  
GIUSSANI

TN4

TN4R  
GIUSSANI



PER:  
FOR:

### TITAN

### TITAN LOCK

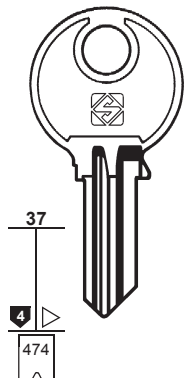

TN9  
... 251-300

TN10

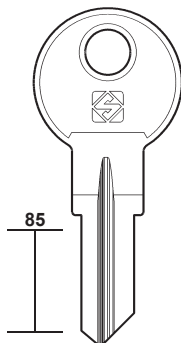

TN6R

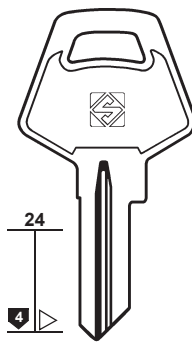

TN11R

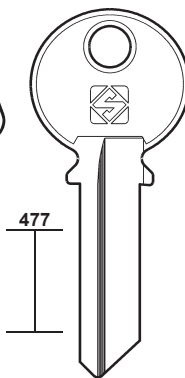

TN14

FTH  
VACHETTE

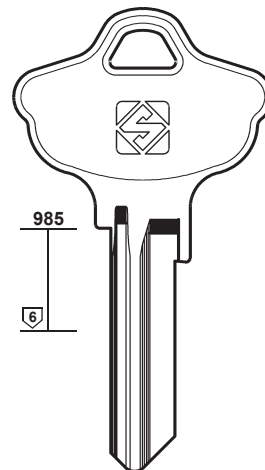

TTL1

KWIKSET



# 184

PER / FOR

**TITAN LOCK** (US)  
KWIKSET

**TITUS** (GB)  
W.M.S. (211)

**TM** (DE)  
DOM (68)

**TOKOZ** (CZ)  
HOPPE (103)

**TOK-TRELOCK** (DE)

**TOK-WINKHAUS** (DE)  
MASTER

PER: **TITAN LOCK**

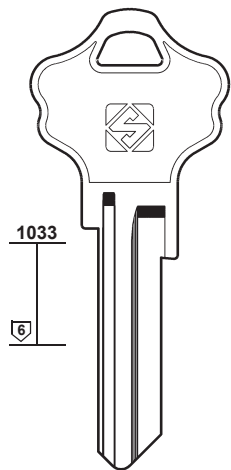

1033



**TTL2**

KWIKSET

FOR: **TOKOZ**

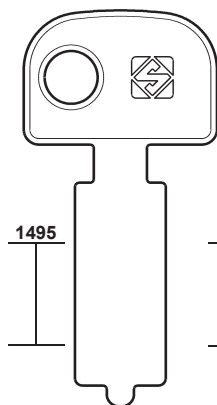

1495

**TO22**

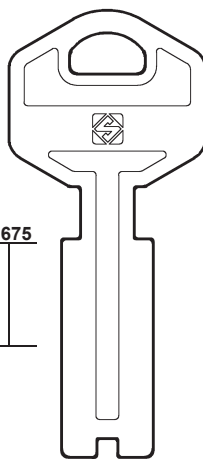

1675

**TO26**

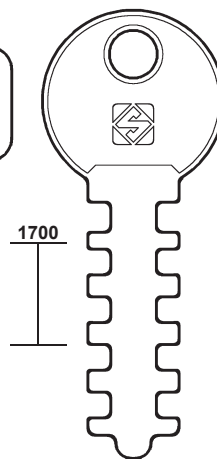

1700

**TOZ13**

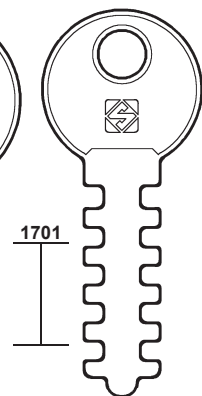

1701

**TOZ14**



PER:  
FOR:

**TOK-TRELOCK**

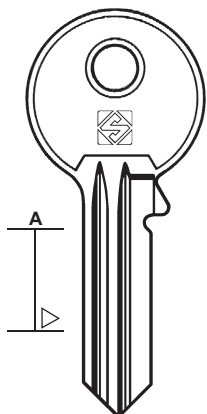

A

**TO26**  
W

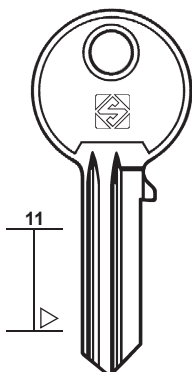

11

**TO23**  
W

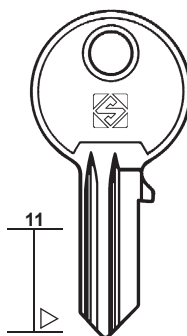

11

**TO24**  
W

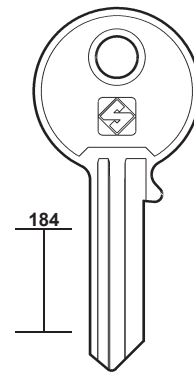

184

**TO44**

PER:  
FOR:

**TOK-TRELOCK**

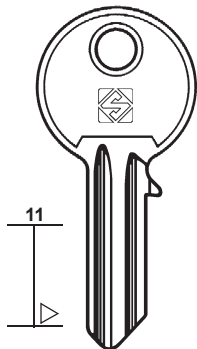

11

**TO22**

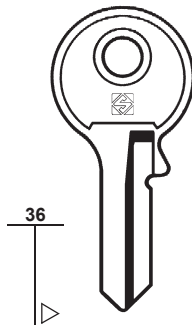

36

**TO12**



FOR: **TOK-WINKHAUS**

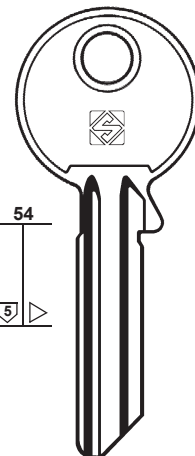

54

**TO29**

**TO92R**

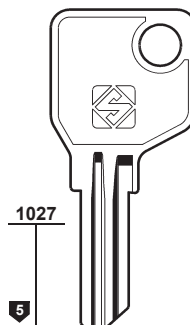

1027

**TO66**



MASTER

PER:  
FOR:

### TOK-WINKHAUS

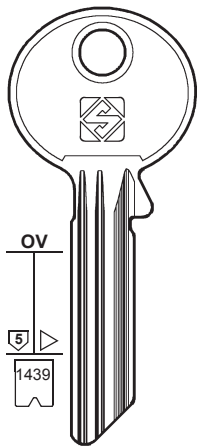

X.....  
0-1-2-3-4-5-6

TO8X1  
 TO8X2  
 TO8X3  
 TO8X4  
 TO8X5  
 TO8X6

TO8RX1  
 TO8RX2  
 TO8RX3  
 TO8RX4  
 TO8RX5  
 TO8RX6

TO8X7  
 TO8X8  
 TO8X9  
 TO8X10  
 TO8X11  
 TO8X12

TO8RX7  
 TO8RX8  
 TO8RX9  
 TO8RX10  
 TO8RX11  
 TO8RX12

TO8X13  
DISQUIN  
 TO8X14  
 TO8X15  
 TO8X16  
 TO8X17  
 TO8X18

TO8RX13  
 TO8RX14  
 TO8RX15  
 TO8RX16  
 TO8RX17  
 TO8RX18

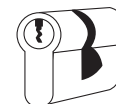

# 185

PER / FOR

**TOK-WINKHAUS (DE)**  
DISQUIN

PER:  
FOR:

### TOK-WINKHAUS

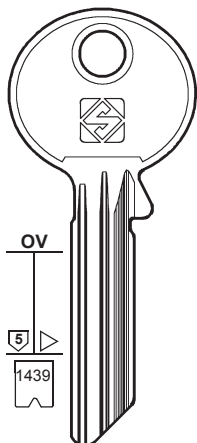

Y.....  
0-1-2-3-4-5-6

TO9Y1  
 TO9Y2  
 TO9Y3  
 TO9Y4  
 TO9Y5  
 TO9Y6

TO9RY1  
 TO9RY2  
 TO9RY3  
 TO9RY4  
 TO9RY5  
 TO9RY6

TO9Y7  
 TO9Y8  
 TO9Y9  
 TO9Y10  
 TO9Y11  
 TO9Y12

TO9RY7  
 TO9RY8  
 TO9RY9  
 TO9RY10  
 TO9RY11  
 TO9RY12

TO9Y13  
 TO9Y14  
 TO9Y15  
 TO9Y16  
 TO9Y17  
 TO9Y18

TO9RY13  
 TO9RY14  
 TO9RY15  
 TO9RY16  
 TO9RY17  
 TO9RY18

PER:  
FOR:

### TOK-WINKHAUS

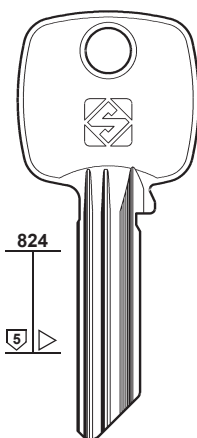

TO50X1  
 TO50X2  
 TO50X3  
 TO50X4  
 TO50X5  
 TO50X6

TO50RX1  
 TO50RX2  
 TO50RX3  
 TO50RX4  
 TO50RX5  
 TO50RX6

TO50X7  
 TO50X8  
 TO50X9  
 TO50X10  
 TO50X11  
 TO50X12

TO50RX7  
 TO50RX8  
 TO50RX9  
 TO50RX10  
 TO50RX11  
 TO50RX12

TO50X13  
 TO50X14  
 TO50X15  
 TO50X16  
 TO50X17  
 TO50X18

TO50RX13  
 TO50RX14  
 TO50RX15  
 TO50RX16  
 TO50RX17  
 TO50RX18



186

PER / FOR

TOK-WINKHAUS (DE)  
COMBA  
EGSA  
SIEBAU  
TRELOCK  
VACHETTE

PER:  
FOR:

### TOK-WINKHAUS

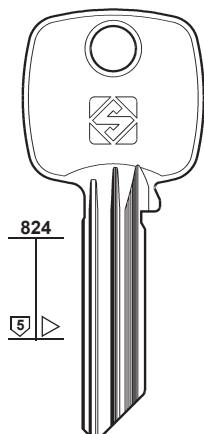

TO51Y1	TO51RY1	TO51Y7	TO51RY7	TO51Y13	TO51RY13
TO51Y2	TO51RY2	TO51Y8	TO51RY8	TO51Y14	TO51RY14
TO51Y3	TO51RY3	TO51Y9	TO51RY9	TO51Y15	TO51RY15
TO51Y4	TO51RY4	TO51Y10	TO51RY10	TO51Y16	TO51RY16
TO51Y5	TO51RY5	TO51Y11	TO51RY11	TO51Y17	TO51RY17
TO51Y6	TO51RY6	TO51Y12	TO51RY12	TO51Y18	TO51RY18

PER:  
FOR:

### TOK-WINKHAUS

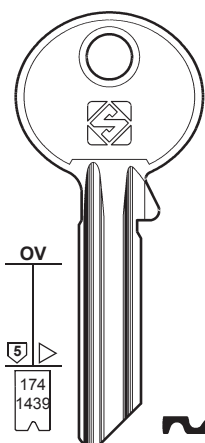

N/T/9 .....  
012345678  
N ..... 0123456  
..... 9 012345678

COMBA - SIEBAU  
TRELOCK - VACHETTE

TO54-1	TO54-2	TO54-3	TO54-4
TO54-5	TO54-6	TO54-7	TO54-8
TO6 9	TO5 Z.....0123456	TO3 11	TO4 12
TO54-13	TO54-14	TO7 15	TO54-16
TO54-17	TO54-18	TO54-19	TO54-20
TO1	TO54-21	TO2 22	TO54-23
TO15	TO16	TO17 EGSA	TO75R
TO25R	TO28R	TO31R	TO82R

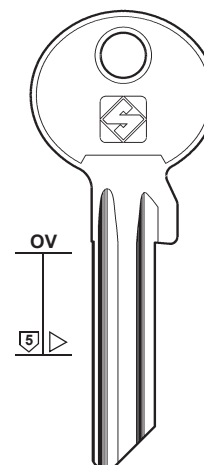

TO1X TO29X

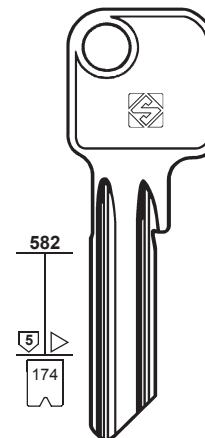

TO10  
P.....  
0-1-2-3-4-5-6-7-8  
TRELOCK

PER:  
FOR:

### TOK-WINKHAUS

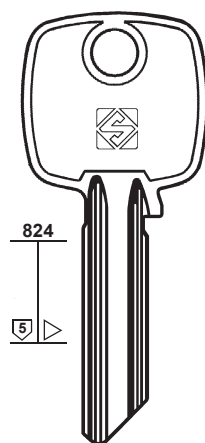

TO35

TO36R

TO41R

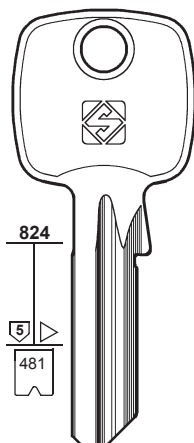

TO114RX  
9.....X  
012345678

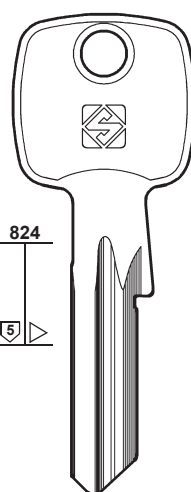

TO120RX

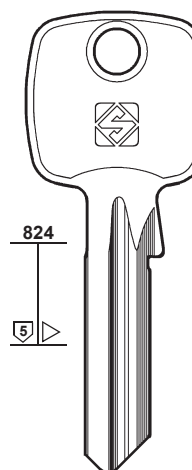

TO124RX

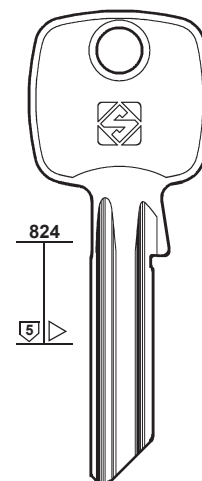

TO125X

PER:  
FOR:

## TOK-WINKHAUS

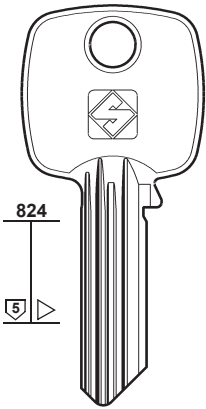

**TO40**   **TO42R**

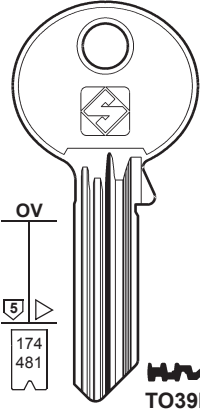

**TO39R**

**TO30**  
9.....T  
012345678

**TO34**

**TO30R**  
9.....X  
012345678  
9.....T  
012345678

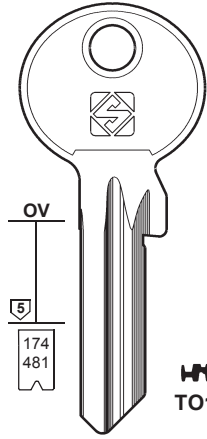

**TO108X**

**TO30X**  
9.....T  
012345678

**TO30RX**  
9.....X  
012345678  
9.....T  
012345678

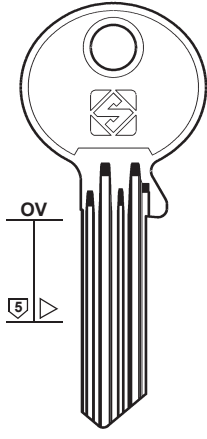

**TO81R**



# 187

PER / FOR

**TOK-WINKHAUS (DE)**  
AZBE  
BIFFAR  
EFAM  
EGSA  
ENAX  
FICHET

**TOP (DE)**  
ABUS  
NOVA  
+ ABUS (6)  
+ WILKA (210)

**TOR (IT)**  
 ZANETTI A. (220)

**TORE (DE)**  
 CES (47)

**TOUCH (GB)**

PER:  
FOR:

## TOK-WINKHAUS

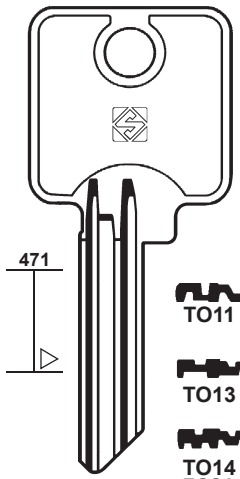

**TO11**  
**TO13**  
**TO14 EGSA**  
**TO21**

AZBE

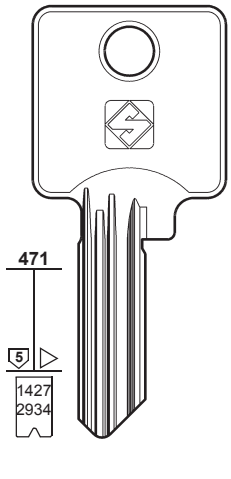

**TO43**

AZBE

**TO27**  
.....  
0123456789

**TO18**

**TO19**

**TO20R**

**TO33**

**TO45**

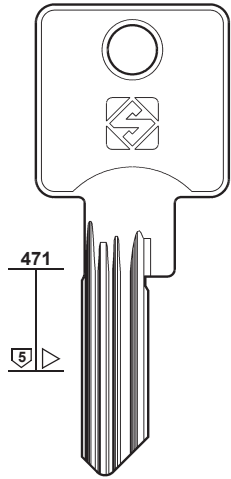

**TO52 ENAX**

**TO53 BFA1**

**TO55 FAABF**

**TO57 EHBA EKCP**

**TO58 EFAM EFWS**

**TO59 EWSB**

**TO60 BFA2**

**TO61 BFA3**

**TO64 BYNY1**

**TO65**

**TO91**

**TO100**

**TO104**

**TO105**

**TO106**

**TO107**

**TO111R**

**TO127**

BIFFAR - FICHET

PER:  
FOR:

## TOP

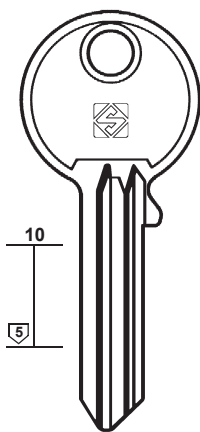

**TOP1R**

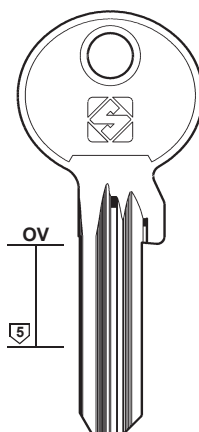

**TOP1RX**

ABUS - NOVA

## TOUCH

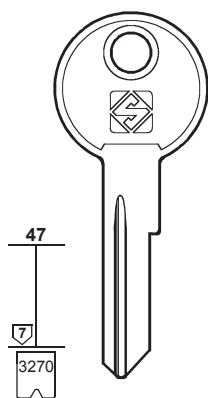

**TOU1R**  
..... 12345

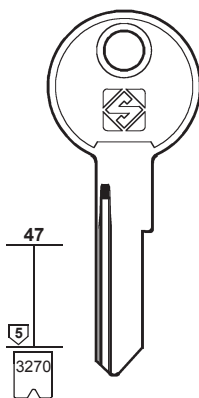

**TOU2R**  
..... 12345

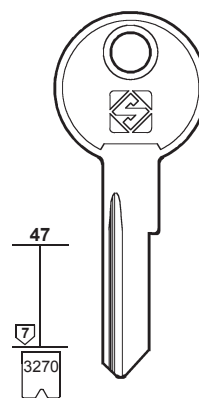

**TOU3R**  
..... 12345





# 188

**PER / FOR****TOVER (ES)**

MASTER

TROMER

+ FTH (92)

**TRABER (GB)**

+ EURO LOCKS (80)

**TRAINS (TW)****TRAU (IT)**

PREFER

**TRELOCK (DE)**

WASO

+ TOK-TRELOCK (184)

+ TOK-WINKHAUS (186)

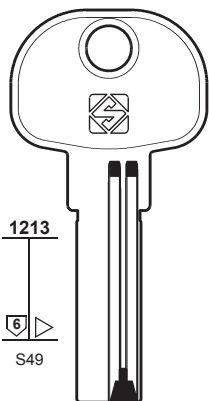
PER:  
FOR:**TOVER**

MASTER

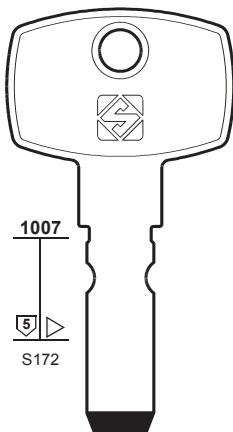

TROMER

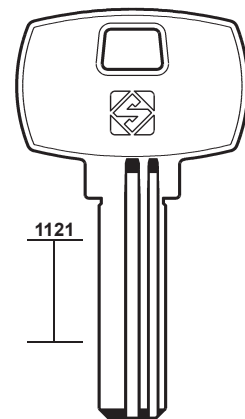
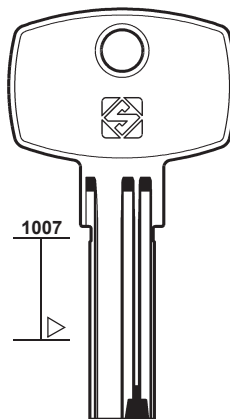
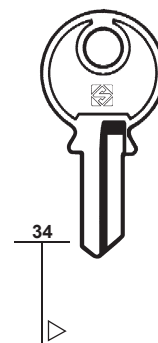
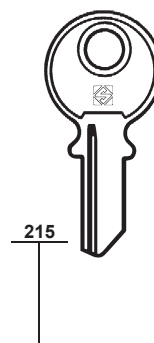
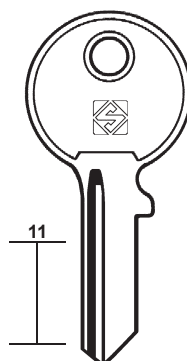
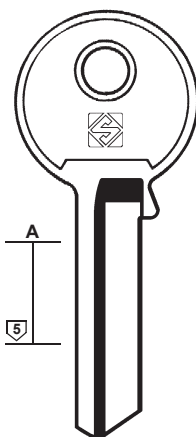
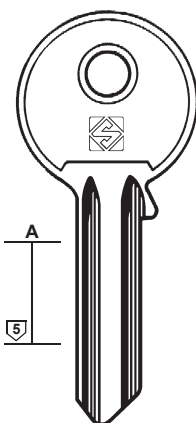
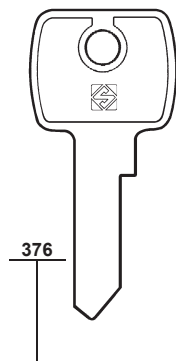
PER:  
FOR:**TRAINS**PER:  
FOR:**TRAU**

PREFER

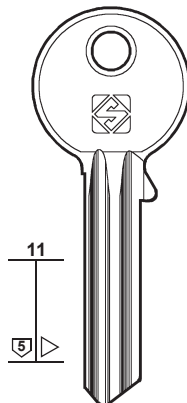
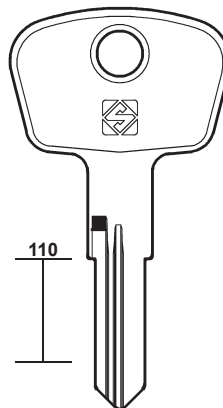
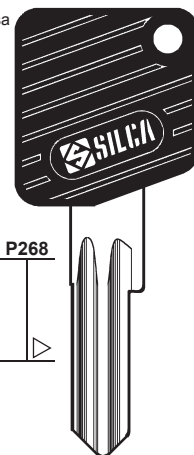
**TRELOCK****TRK9R**Red head  
Testa rossa

WASO

PER:  
FOR:

# TRELOCK

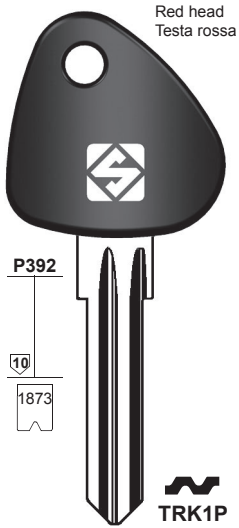

R6 .....  
0-1-2

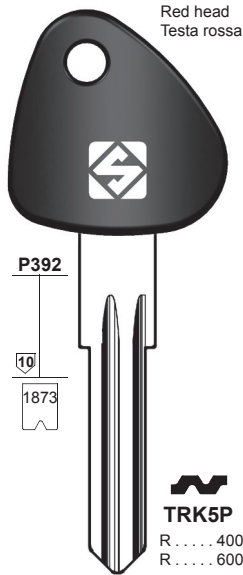

R ..... 40000-46941  
R ..... 60001-74039

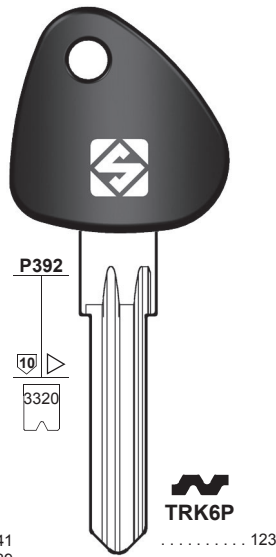

..... 123

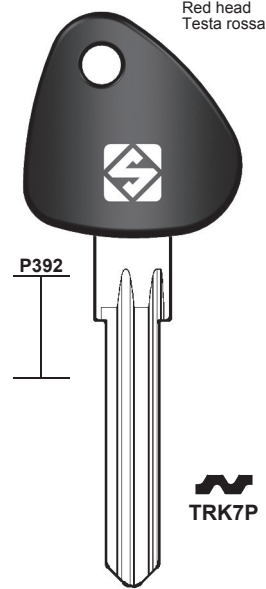

# 189

PER / FOR

**TRELOCK (DE)**  
 + LUMA (130)  
 + TOK-TRELOCK (184)  
 + TOK-WINKHAUS (186)

**TRI-CIRCLE (TW)**  
 ABUS  
 ELEPHANT  
 + DOUBLE CIRCLE (75)

PER:  
FOR:

# TRELOCK

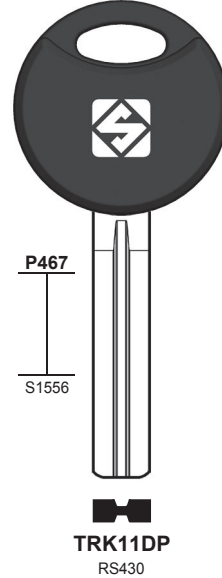
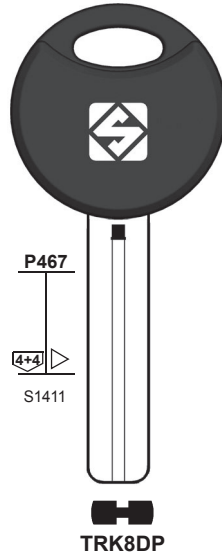
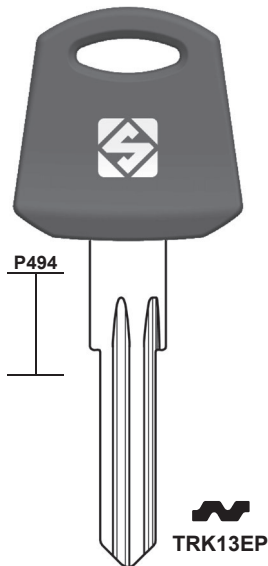
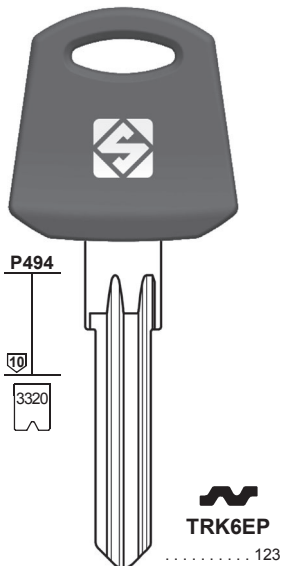

PER:  
FOR:

# TRI-CIRCLE

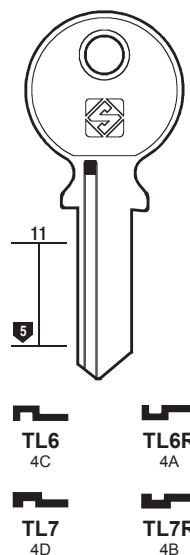
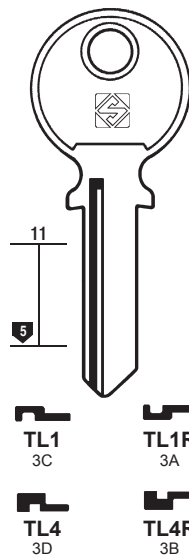
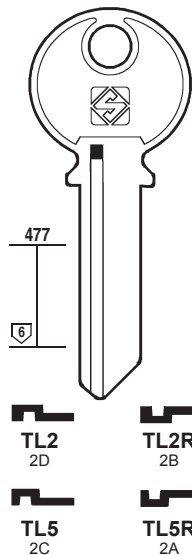
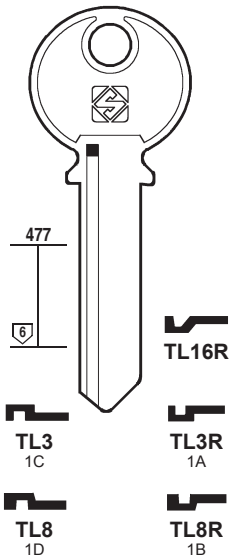



# 190

PER / FOR

**TRI-CIRCLE (TW)**  
ABUS  
MARK  
YONGTAI  
+ **DOUBLE CIRCLE (75)**

**TRIMARK (US)**

**TRIO (NO)**  
 **TRIOVING (190)**

**TRIOVING (NO)**  
TRIO

PER:  
FOR:

## TRI-CIRCLE

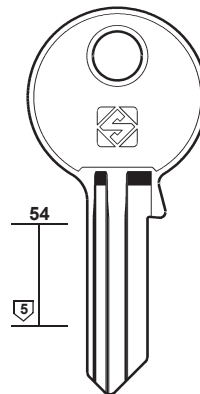
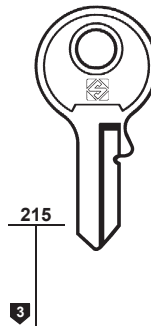
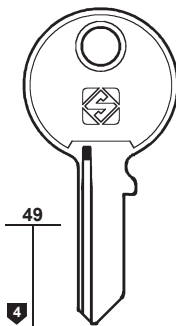
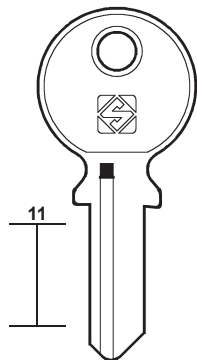

ABUS - MARK



PER:  
FOR:

## TRI-CIRCLE

## TRIMARK

## TRIOVING

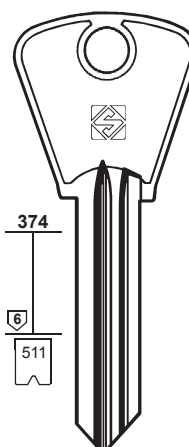
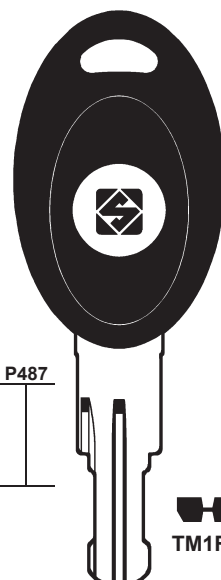
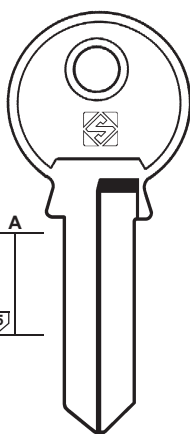
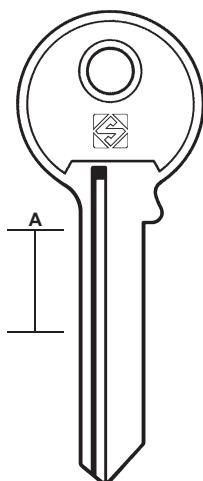

0-1-2-3-4-5-6-7-8-9-A

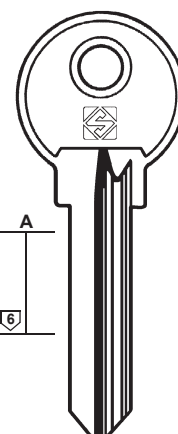

TRIO

PER:  
FOR:

## TRIOVING

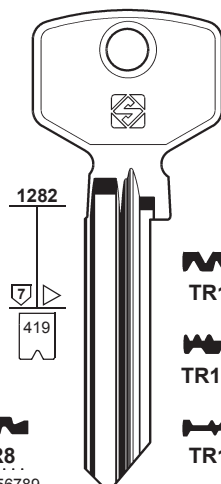

0123456789

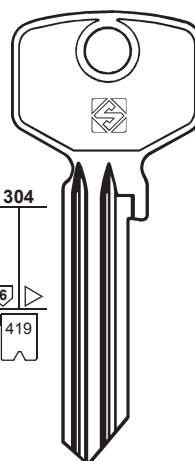

..... 0123456789  
..... NK 1-18342  
..... 1-26770  
..... 30000-56769  
..... ND 1-99999  
D ..... 1-13278  
DCN ..... 82660  
..... 1-13278  
..... 1-26770

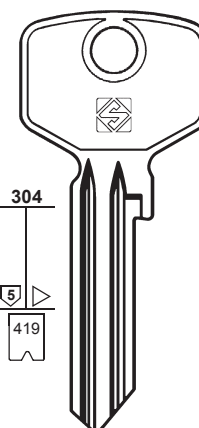

0-1-2-3-4-5-6-7-8-9



PER:  
FOR:

### TRIOVING

### TRI STAR

### TULA

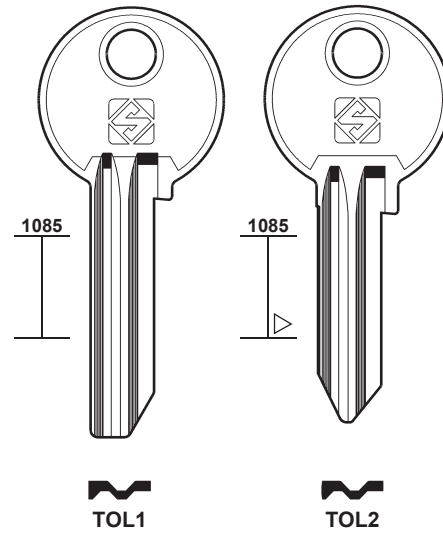
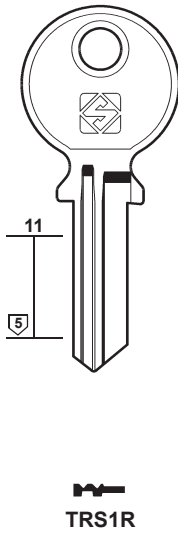
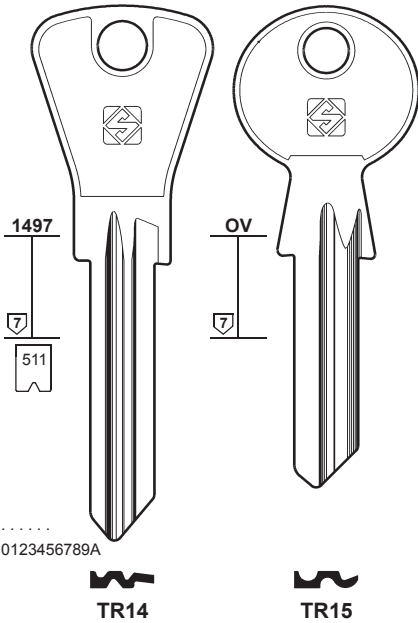

.....  
0123456789A



# 191

- PER / FOR**
- TRIOVING** (NO)
  - TRI STAR** (TW)
  - TRITON** (DE)
    - 👁️ CES (47)
    - 👁️ JOWIL (110)
  - TROMER** (ES)
    - 👁️ MCM (134)
    - 👁️ TOVER (188)
  - TRUMPF** (DE)
    - 👁️ TH (182)
  - TRYBA** (AT)
    - 👁️ EVVA (80)
  - TULA** (RU)
  - TUSHINO** (RU)
  - TÜRSCHLOSS** (DE)
    - 👁️ TAS (180)
  - TWINLOCK** (GB)
  - TWIRHONB** (FR)
    - 👁️ ASIA (20)
  - TZAFRER** (GR)
    - + 👁️ CISA (55)
    - + 👁️ GEGE (93)
  - UAP** (GB)

PER:  
FOR:

### TUSHINO

### TWINLOCK

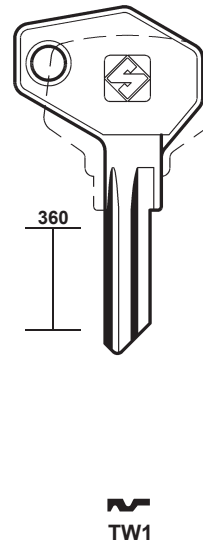
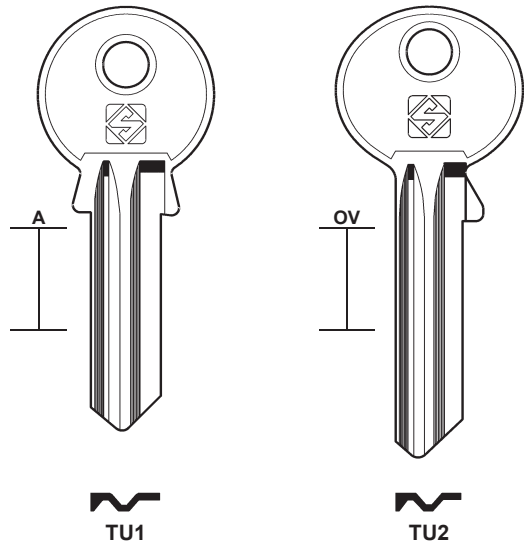

PER:  
FOR:

### TZAFRER

### UAP

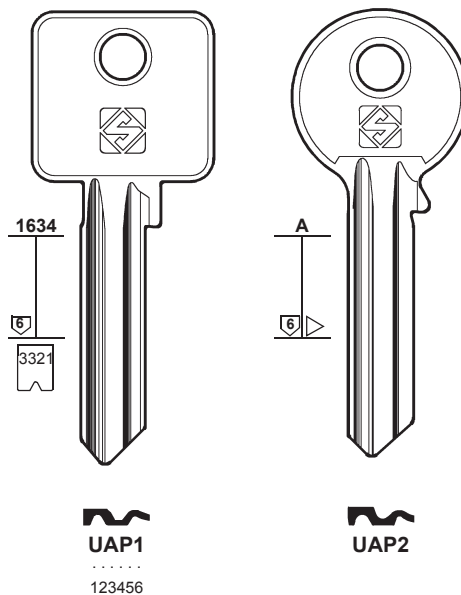
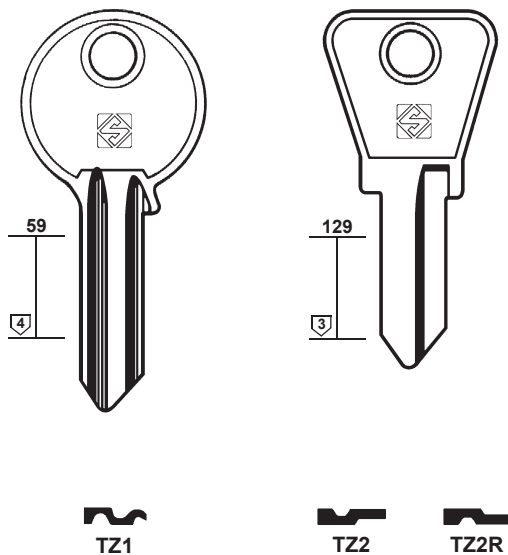



# 192

### PER / FOR

**UCEM** (ES)  
 CIB  
 ESAFE  
 ISEO  
 RIV  
 YEMAR

**UEME** (BR)

**ULIANOVSK** (RU)

**ULTRA** (GB)  
 L & F (128)

**UMF** (PT)  
 + YALE (213)

**UNIFERRO** (FR)  
 CISA (55)

**UNIFOR** (IT)  
 PREFER (157)

PER:  
FOR:

## UCEM

29  
5  
811

1204  
5

P244  
5  
S170  
S196

1203  
5  
S170  
S196

1203

UC2

UC1 UC1R  
..... 1-2-3-4-5-6

UC6R

UC3RP  
2000S

UC5R

UC4R

CIB - RIV

ESAFE - ISEO  
YEMAR

PER:  
FOR:

## UCEM

## UEME

1386

1156

1156  
5

1292  
4

UC8R

UE5R

UE4R

UE2R

PER:  
FOR:

## UEME

## ULIANOVSK

## UMF

1292  
5

1088

54

A

UE3R

ULS1R

UM1 UM1R

UM2

PER:  
FOR:

# UNION



# 193

PER / FOR

UNION (GB)  
HENDERSON  
ONIUN

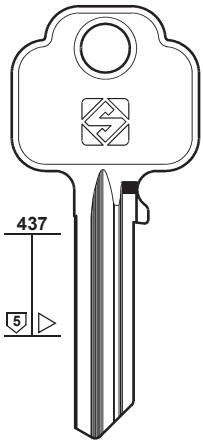

**UNI66R**  
B-MLA

**UNI68R**  
NE

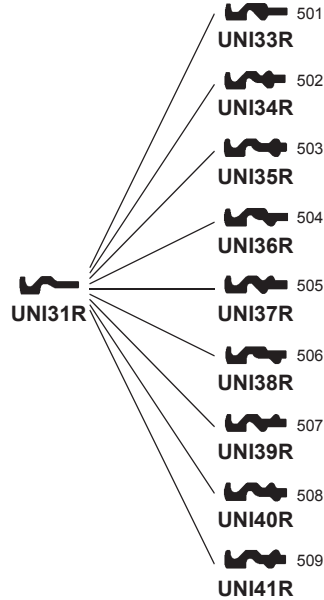
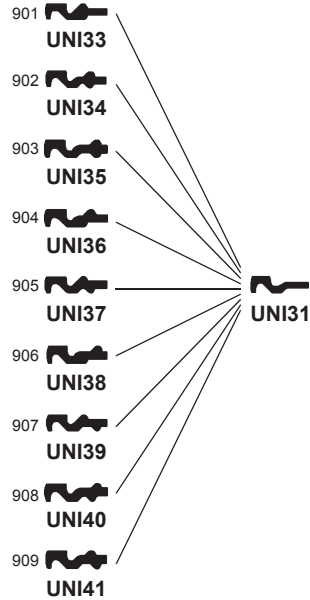

PER:  
FOR:

# UNION

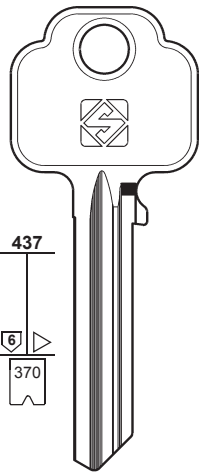

**UNI67R**  
B-MLA

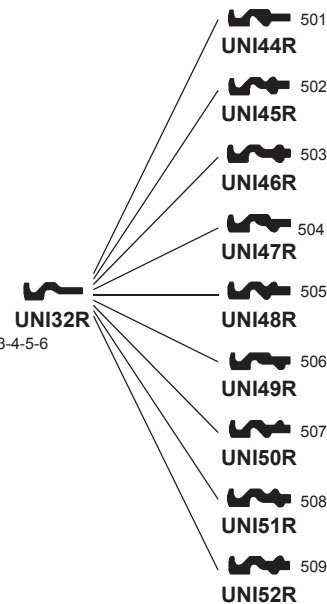
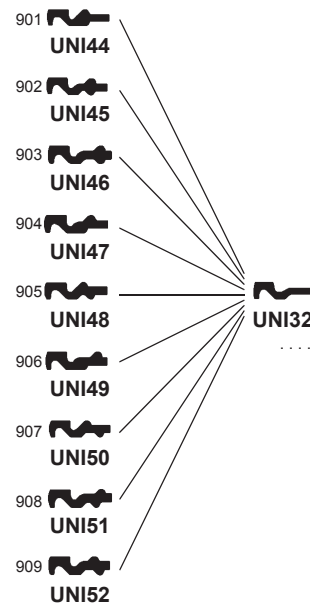

PER:  
FOR:

# UNION

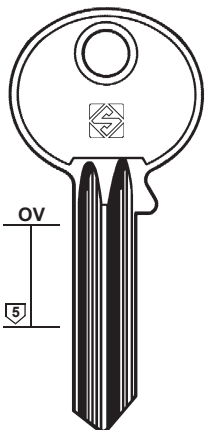

**UNI28**  
KB506

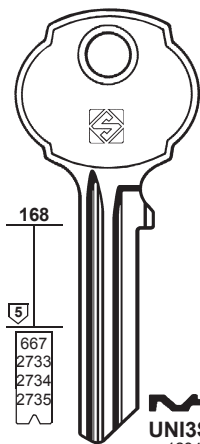

**UNI3**  
KB502  
..... 1-2-3-4-5-6  
..... 1-2-3-4-5-6-7-8

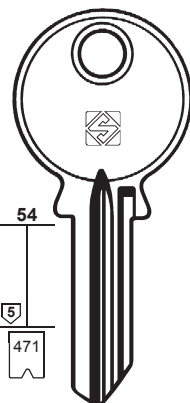

**UNI3S**  
..... 123456  
..... 12345678

**UNI54R**  
ZA1

**UNI18**  
NJ ...  
1-1500

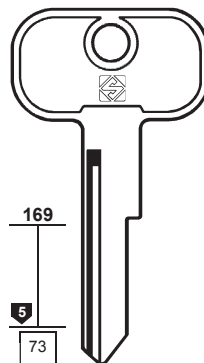

**UNI6**  
FR ... 751-875

**UNI16**  
... 1-99  
FS ... 1-99  
FS ... 876-955

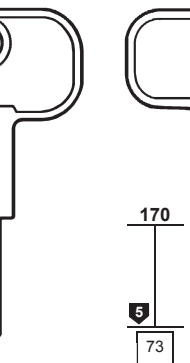

**UNI7**  
FP ... 626-750  
HENDERSON

**UNI16R**  
FK ... 1-99  
FK ... 876-955

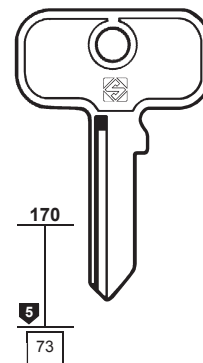

**UNI11**  
FP ... 626-750

**UNI14**  
... 1-99  
FS ... 1-99  
FS ... 876-955

ONIUN



194

PER / FOR

UNION (GB)

UNIVERSAL

PER:  
FOR:

# UNION

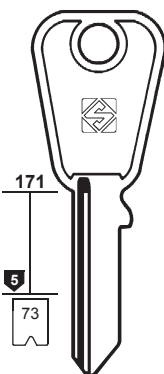

**UNI12**

FP ... 626-750



**UNI15**

... 1-99  
FS ... 1-99  
FS ... 876-955

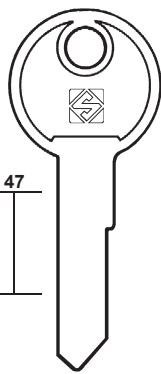

**UNI29**

KB682

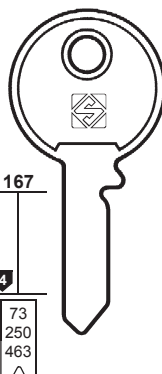

**UNI4**

NRA  
FFE ... 1-100  
FL ... 251-500  
NRA ... 51-90  
FG ... 1-30  
NF ... 1-30  
EJR ... 1-75  
FMO ... 1-75

**UNI63**

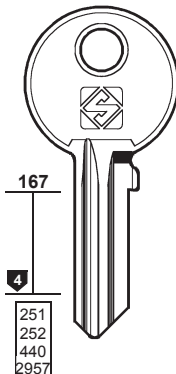

**UNI4R**

EJR ... 1-75



**UNI5**

NGN ... 1-54



**UNI6**



**UNI27**

KB53A

NKL ... 151-300  
NND ... 151-300  
TBS ... 201-350

NKW/A ... 1001-1100  
NKW/A ... 1-100  
NKW/X ... 1-100  
NKW/H ... 1-50  
NKL ... 301-450  
NND ... 1-150  
NND ... 301-450  
NPK ... 1-100

TBS ... 1-100  
NKL ... 1-150  
NND ... 1-150  
TBS ... 1-50  
TBS ... 101-200  
TBS ... 201-300  
TBS ... 201-350  
TBS ... 301-400  
TBS ... 401-500



**UNI22**



**UNI23**



**UNI30**



**UNI56R**



**UNI57R**



**UNI58R**



**UNI61R**



**UNI61**

PER:  
FOR:

# UNION

# UNIVERSAL SERIE DISTINZIONE

HEAD TYPE / TESTA TIPO **N**

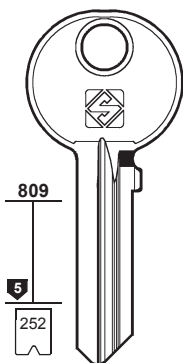

**UNI59R**

NKW/A ... 1-100  
NKW/A ... 1001-1100  
NPK ... 1-100



**UNI60R**

NKW/X ... 201-300  
NKW/A ... 201-300

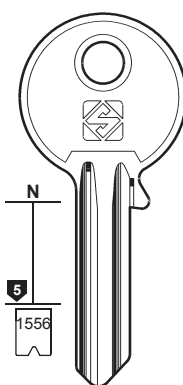

**UL058**

... 123456



**UL059**

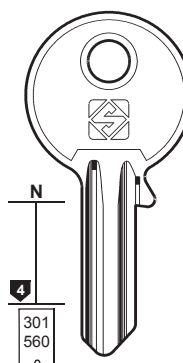

**UL060**

... 501-700  
... 1001-1500



**UL061**

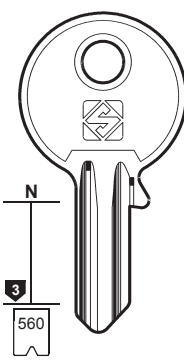

**UL056**

... 1701-1810  
... T 1-113



**UL057**

PER:  
FOR:

# UNIVERSAL SERIE DISTINZIONE

HEAD TYPE / TESTA TIPO **A**

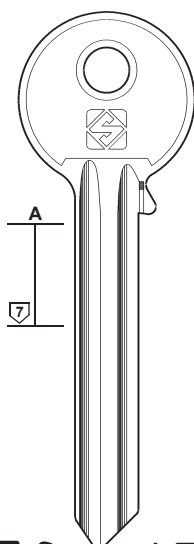

**UL046**



**UL047**

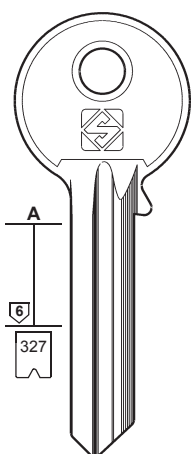

**UL054** ... 123456



**UL055**

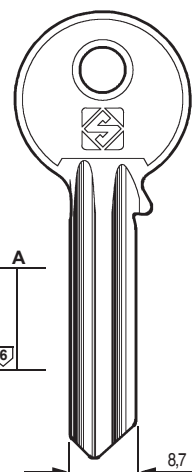

**UL064**

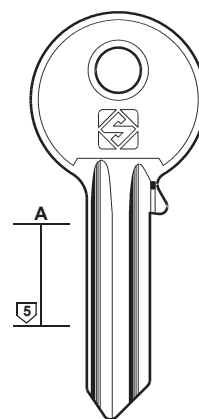

**UL050**



**UL051**

PER:  
FOR:

# UNIVERSAL SERIE DISTINZIONE

## HEAD TYPE / TESTA TIPO A



# 195

PER / FOR

UNIVERSAL

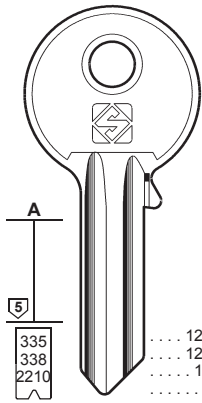

UL062

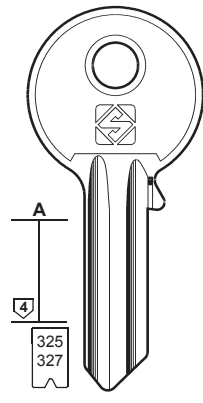

UL052 ..... 0123456789  
..... 123456

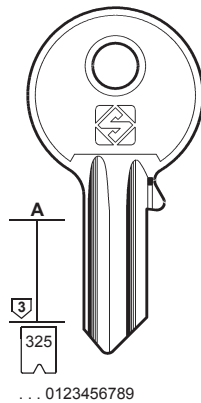

UL048

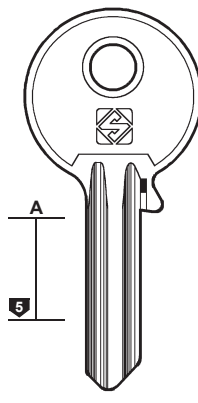

UL058A



PER:  
FOR:

# UNIVERSAL SERIE DISTINZIONE

## HEAD TYPE / TESTA TIPO B

## HEAD TYPE / TESTA TIPO C

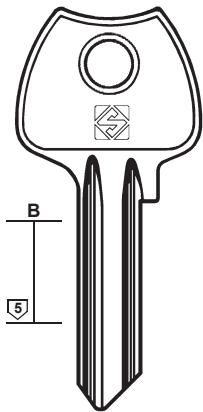

UL050B

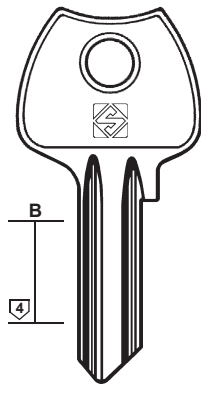

UL052B

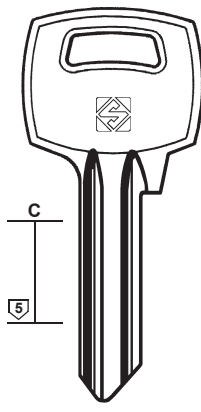

UL050C

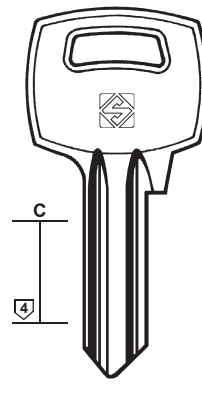

UL052C



PER:  
FOR:

# UNIVERSAL SERIE DISTINZIONE

## HEAD TYPE / TESTA TIPO D

## HEAD TYPE / TESTA TIPO DC

## HEAD TYPE / TESTA TIPO E

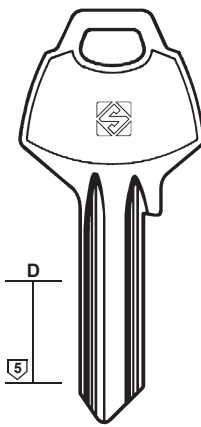

UL050D

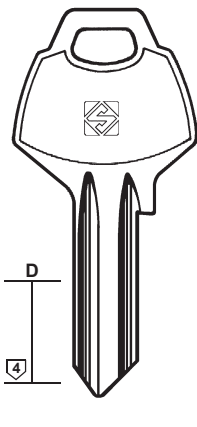

UL052D

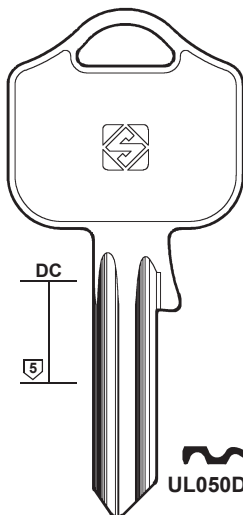

UL050DC

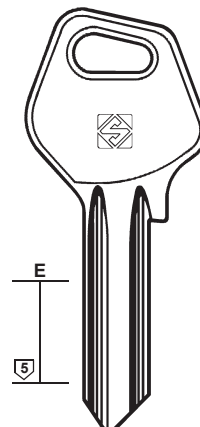

UL050E

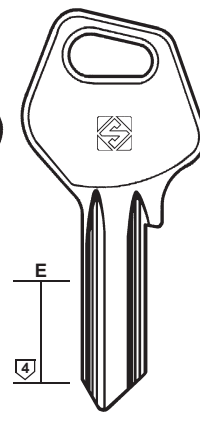

UL052E





196

PER / FOR  
UNIVERSAL

PER:  
FOR:

### UNIVERSAL SERIE DISTINZIONE

HEAD TYPE / TESTA TIPO **F**

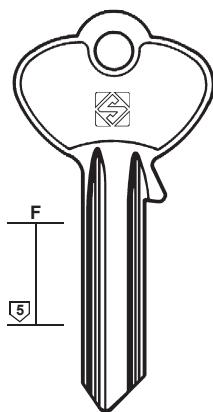

UL050F

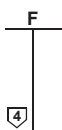
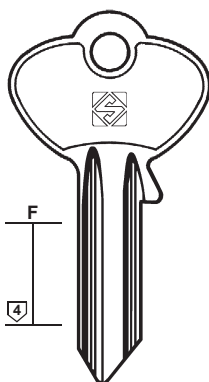

UL052F

HEAD TYPE / TESTA TIPO **G**

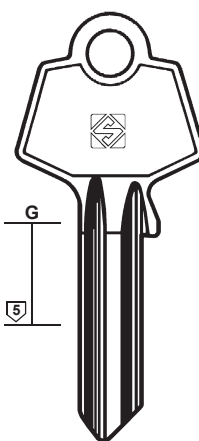

UL050G

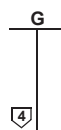
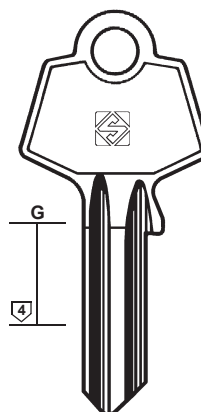

UL052G



PER:  
FOR:

### UNIVERSAL SERIE DISTINZIONE

HEAD TYPE / TESTA TIPO **H**

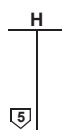
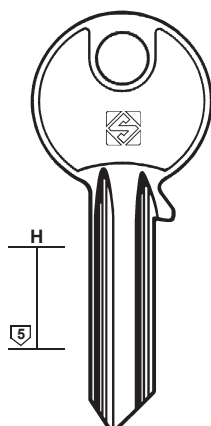

UL050H

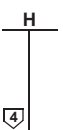
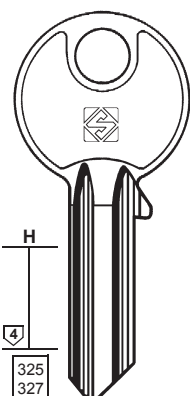

325  
327  
330  
335  
338

UL052H

..... 012345678  
..... 0123456789  
..... 12345  
..... 123456

HEAD TYPE / TESTA TIPO **L**

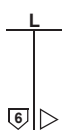
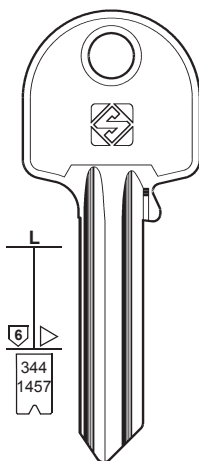

UL054L

UL055L ..... 12345678  
..... 123456789

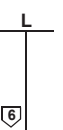
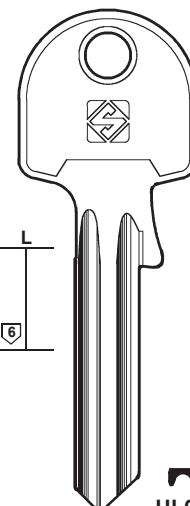

UL054SL

UL055SL

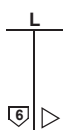
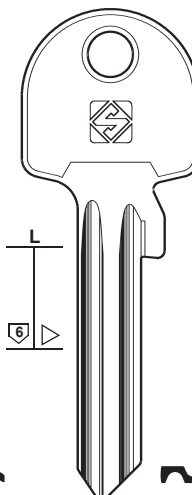

UL054XL

UL055XL

PER:  
FOR:

### UNIVERSAL SERIE DISTINZIONE

HEAD TYPE / TESTA TIPO **L**

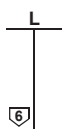
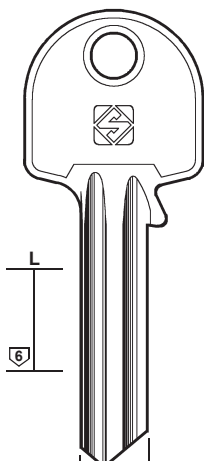

UL064L

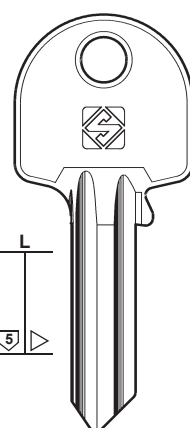

UL050L

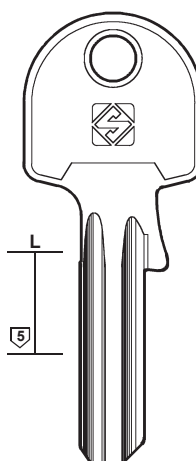

UL050SL

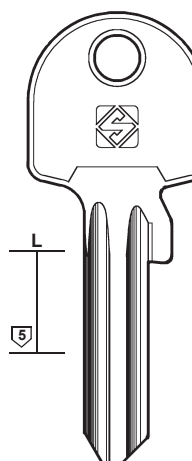

UL050XL



PER:  
FOR:

# UNIVERSAL SERIE DISTINZIONE

HEAD TYPE / TESTA TIPO **L**

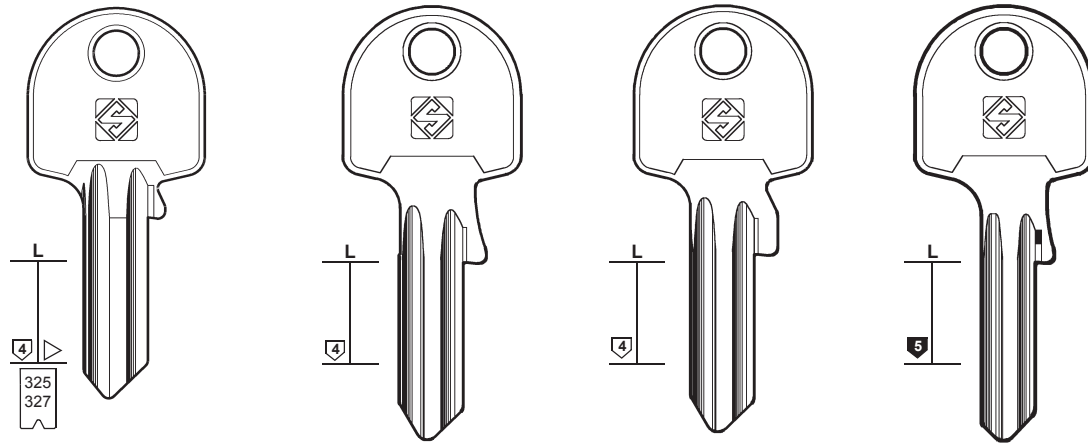

..... 0123456789  
 UL052L ..... 123456  
 ..... 123456  
 UL053L ..... 123456

.....  
 UL052SL  
 .....  
 UL053SL

.....  
 UL052XL  
 .....  
 UL053XL

.....  
 UL058SL



# 197

PER / FOR

UNIVERSAL

U.P.R. (DE)

URBIS (RO)  
BSS  
YALE

PER:  
FOR:

# UNIVERSAL SERIE DISTINZIONE

HEAD TYPE / TESTA TIPO **M**

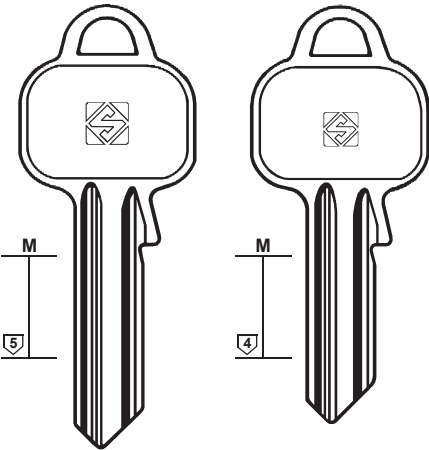

.....  
 UL050M  
 .....  
 UL051M

.....  
 UL052M  
 .....  
 UL053M

HEAD TYPE / TESTA TIPO **OV**

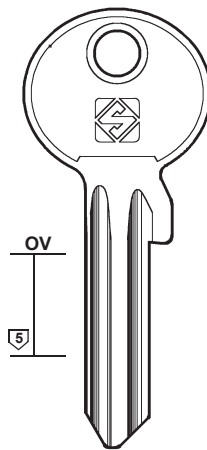

.....  
 UL050X  
 .....  
 UL051X

HEAD TYPE / TESTA TIPO **Y**

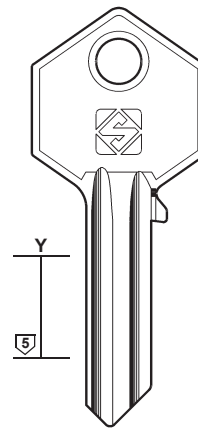

.....  
 UL050Y  
 .....  
 UL051Y

PER:  
FOR:

## U.P.R.

## URBIS

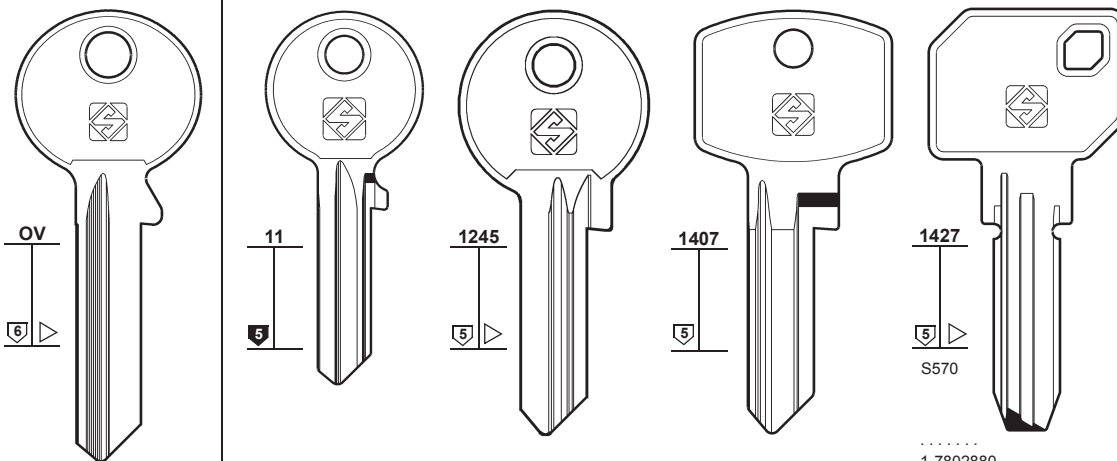

.....  
 UP1

.....  
 UB1R

.....  
 UB2R

.....  
 UB5

.....  
 UB3

YALE



BSS - YALE



# 198

PER / FOR

**URKO (ES)**

**UTZ (CH)**

- 👁️ FORT (90)
- 👁️ L & F (128)
- 👁️ SIS (170)

**VACHETTE (FR)**

- ATAL
- DAD
- ISEO
- KILT
- JU
- RUKA
- SANPEUR
- VINCO
- + 👁️ ISEO (108)
- + 👁️ KWIKSET (119)
- + 👁️ TITAN (183)
- + 👁️ TOK-WINKHAUS (186)
- + 👁️ VEGA (204)

## PER: URKO

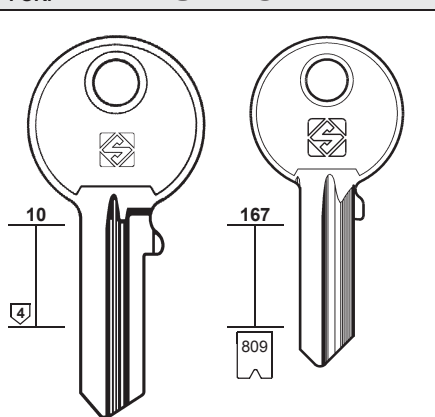

1-2-3-4-5-6

## PER: VACHETTE

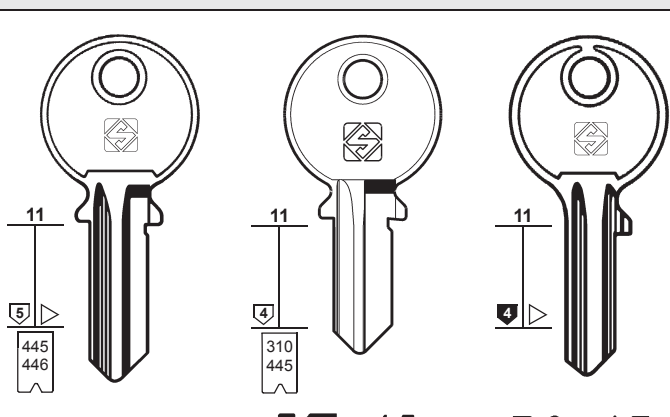

**VAC46**      **VAC1**      **VAC1R**      **VAC8**      **VAC8R**

- ..... 1-2-3-4-5-6-7-8
- B ..... 1-2-3-4-5-6-7-8
- ..... E 1-2-3-4-5-6-7-8-9-0
- E ..... 9001-9100
- ... E 300-499
- ... R 9001-9100
- ..... 1-2-3-4-5-6-7-8-9-0
- ..... 1-2-3-4-5-6-7-8-9-0
- ... E 1-2-3-4-5-6-7-8-9-0



## PER: VACHETTE

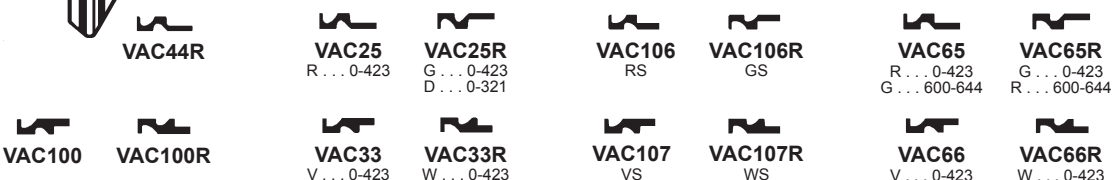
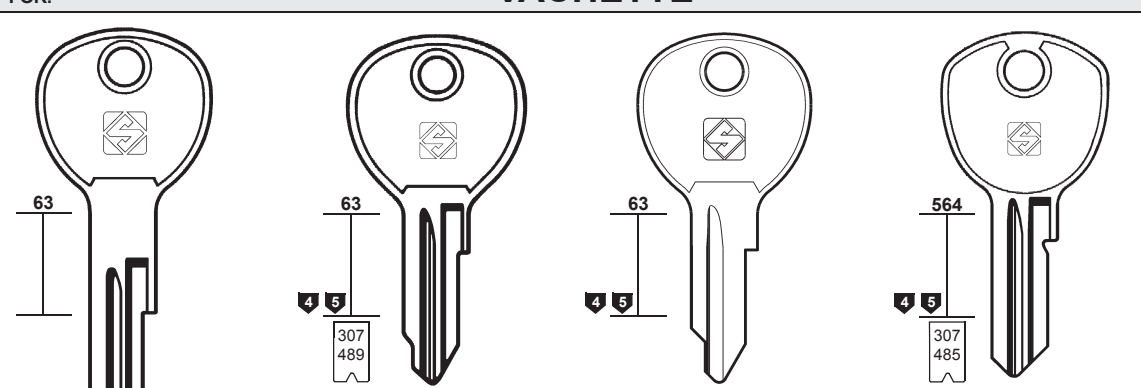

VINCO

ATAL - VINCO

ATAL - VINCO

## PER: VACHETTE

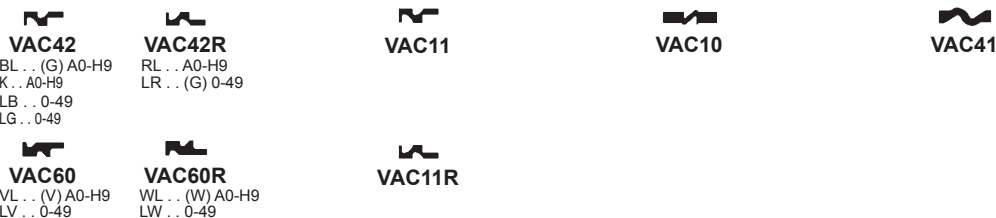
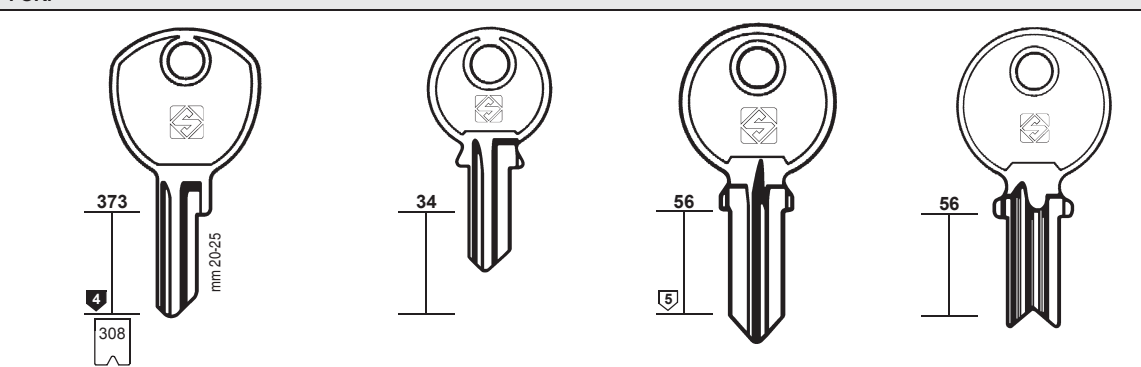

**VAC42**      **VAC42R**  
 BL... (G) A0-H9      RL... A0-H9  
 K... A0-H9      LR... (G) 0-49  
 LB... 0-49  
 LG... 0-49

**VAC60**      **VAC60R**  
 VL... (V) A0-H9      WL... (W) A0-H9  
 LV... 0-49      LW... 0-49





PER:  
FOR:

## VACHETTE



# 199

PER / FOR

**VACHETTE (FR)**  
 DAD  
 FONTAINE  
 HEMA  
 METALUX  
 MODERN BAU  
 RONIS  
 + ISEO (108)  
 + KWIKSET (119)  
 + TITAN (183)  
 + TOK-WINKHAUS (186)  
 + VEGA (204)

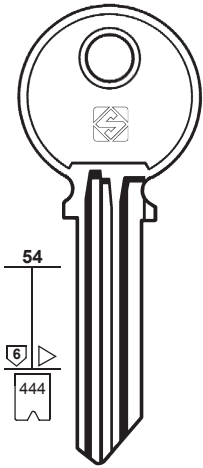

**RO41**

..... 1-1296  
 ..... 1-2-3-4-5-6-7-8-9-0  
 V20 ..... 1-1296  
 A/Z 1-2-3-4-5-6-7-8-9-0



**DAD - RONIS**

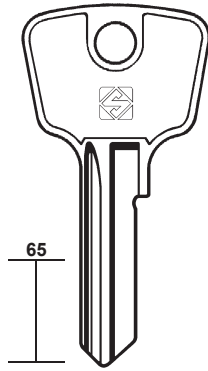

**VAC14**



mm 40-50-60

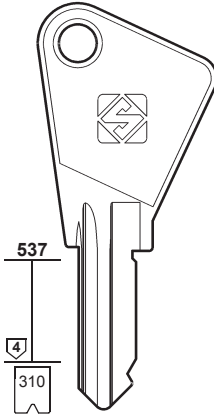

**VAC61**

EE ..... 9001-9100  
 E ..... 2-3-4-5-6

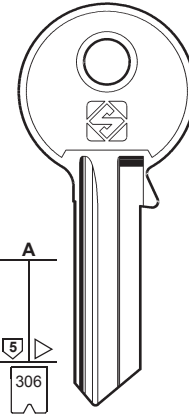

**VAC29**

A1 ..... 5001-5631

**FONTAINE - HEMA  
 METALUX - MODERN BAU**

PER:  
FOR:

## VACHETTE

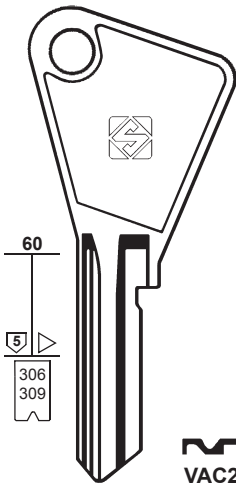

**VAC2**

A1 ..... 5001-5631  
 UL ..... 1-3500  
 U ..... 1-2-3-4-5-6-7-8-9-0  
 U0 ..... 1-9999  
 JA ..... 0001-1252  
 UB ..... 0001-5002  
 UA ..... 0830-6334  
 LA ..... 0000-6334

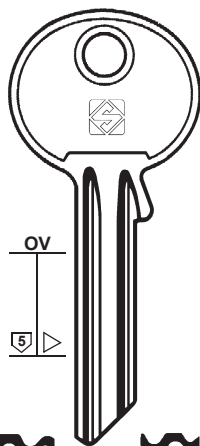

**VAC30**

**VAC30R**

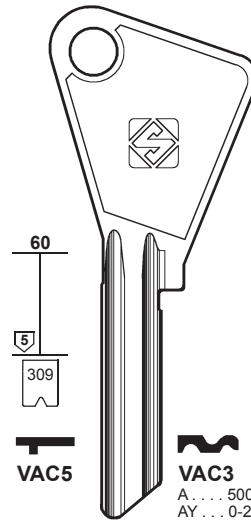

**VAC5**

**VAC3**

A ..... 5000-5635  
 AY ..... 0-249  
 Y ..... 0-249  
 AS ..... 0-099  
 S ..... 0-099  
 A ..... 2000-2999  
 A ..... 3000-3199  
 AA ..... 0000-1999



mm 30-45

PER:  
FOR:

## VACHETTE

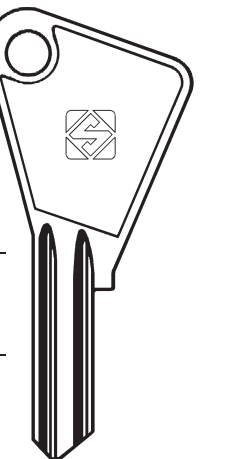
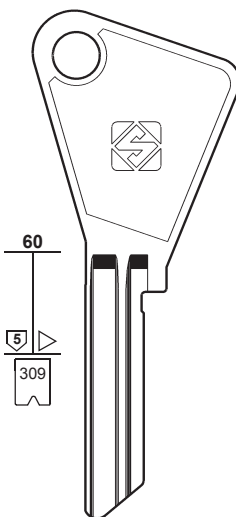

**VAC4**  
 AY ..... 0-249  
 Y ..... 0-249

**VAC56**  
 AM ..... 870-894

**VAC47**  
 BM ..... 870-894

**VAC57**  
 CM ..... 870-894

**VAC58**  
 DM ..... 870-894

**VAC63**  
 AM ..... 870-894  
 BM ..... 870-894  
 CM ..... 870-894  
 DM ..... 870-894



200

PER / FOR

VACHETTE (FR)

- + ISEO (108)
- + KWIKSET (119)
- + TITAN (183)
- + TOK-WINKHAUS (186)
- + VEGA (204)

PER:  
FOR:

## VACHETTE

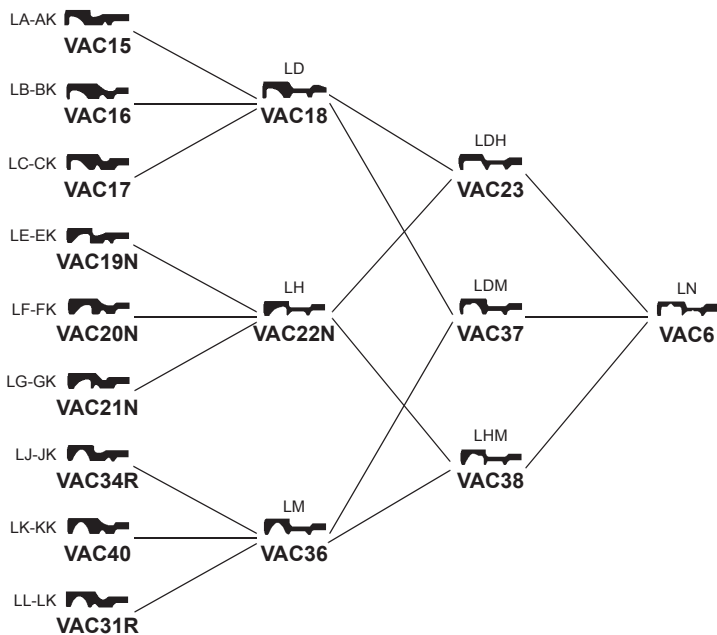
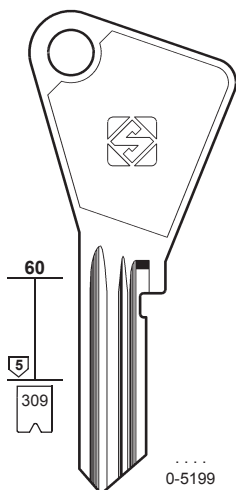

PER:  
FOR:

## VACHETTE

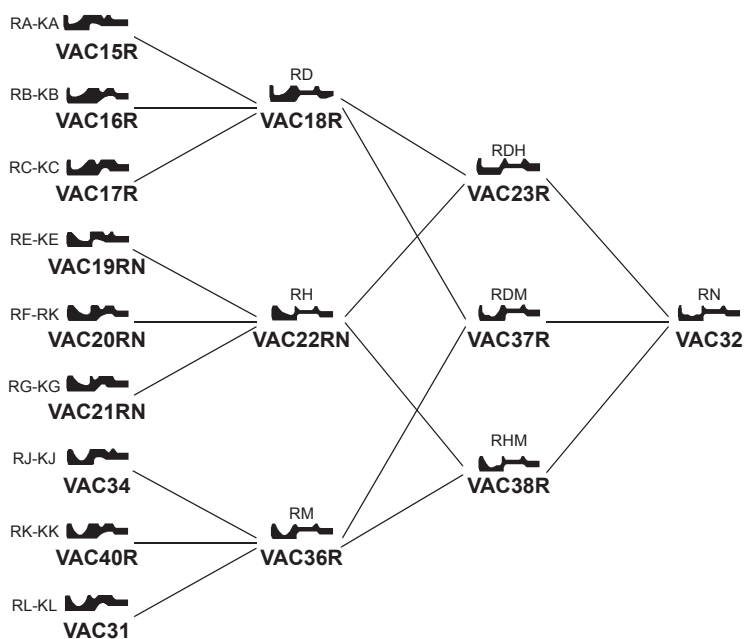
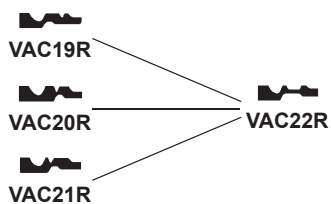
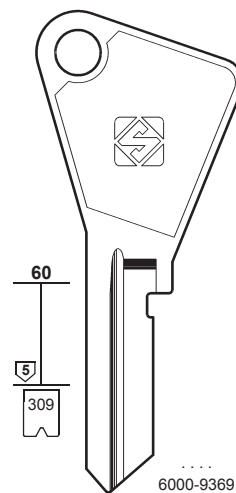

PER:  
FOR:

# VACHETTE



# 201

PER / FOR

**VACHETTE (FR)**  
 AZMA  
 CAP  
 + ISEO (108)  
 + KWIKSET (119)  
 + TITAN (183)  
 + TOK-WINKHAUS (186)  
 + VEGA (204)

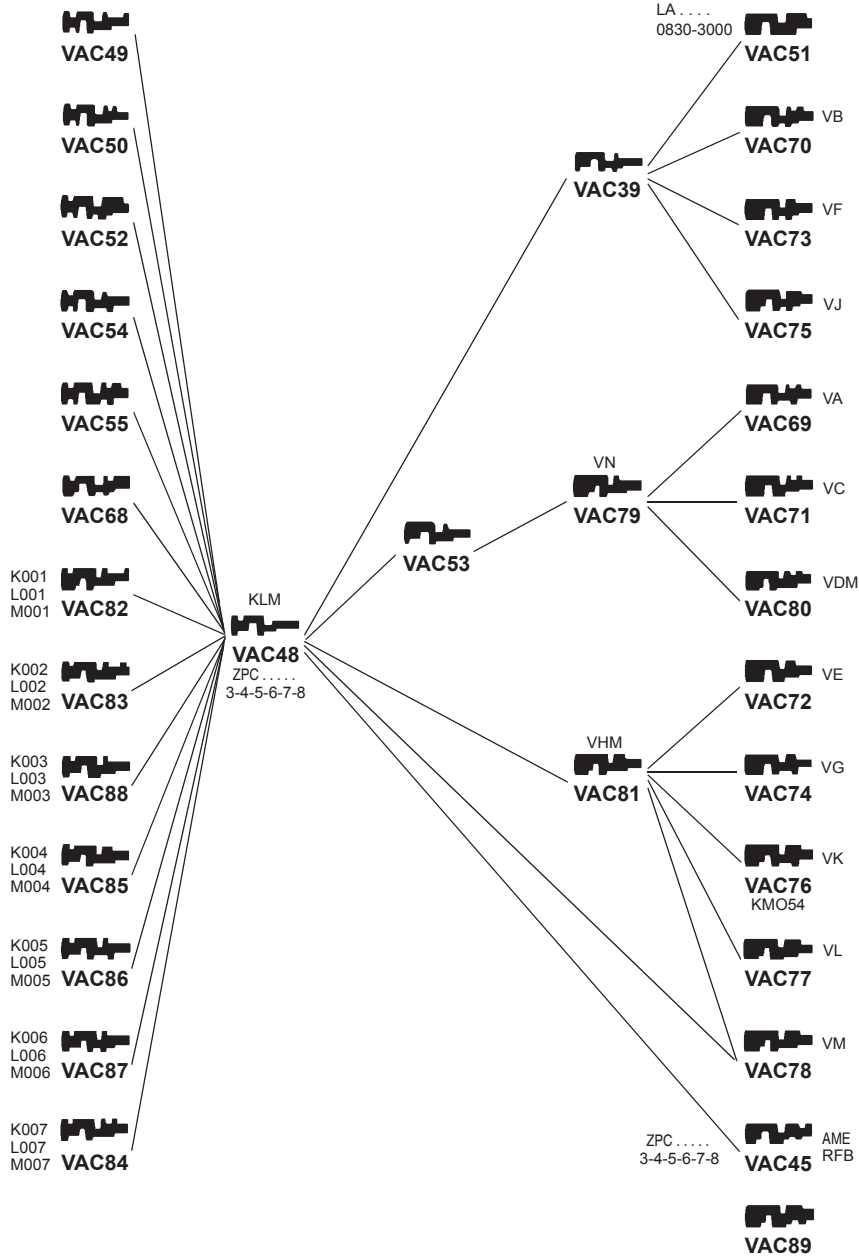
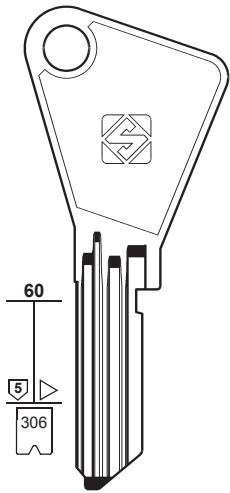

AZMA - CAP



202

PER / FOR

VACHETTE (FR)  
LAPERCHE

- + ISEO (108)
- + KWIKSET (119)
- + TITAN (183)
- + TOK-WINK-HAUS (186)
- + VEGA (204)

PER:  
FOR:

VACHETTE

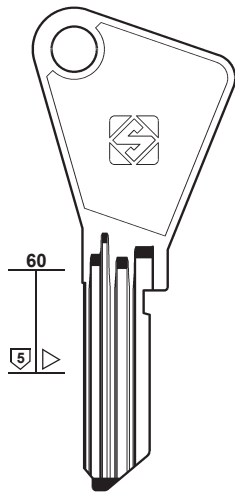

  
VAC101  
KM235

  
VAC108  
K200

  
VAC109  
L202

  
VAC110  
L226

  
VAC111  
L229

  
VAC112  
L230

  
VAC113  
L240

  
VAC114  
KL229

  
VAC115  
K247

  
VAC116  
KM236

  
VAC117  
M258

  
VAC118  
L225

  
VAC119  
L243

  
VAC120  
K023

  
VAC121  
K024

  
VAC122  
K025

  
VAC123  
K234

  
VAC124  
K235

  
VAC125  
K236

  
VAC126  
K237

  
VAC127  
K238

  
VAC128  
K239

  
VAC129  
K240

  
VAC130  
K242

  
VAC131  
K243

  
VAC132  
K244

  
VAC133  
K245

  
VAC134  
P294

  
VAC135  
L019

  
VAC136  
L020

  
VAC137  
L021

  
VAC138  
L022

  
VAC139  
L223

  
VAC140  
L224

  
VAC141  
L227

  
VAC142  
L228

  
VAC143  
L239

  
VAC144  
L244

  
VAC145  
L245

  
VAC146  
L246

  
VAC147  
K020

  
VAC148  
K021

PER:  
FOR:

VACHETTE

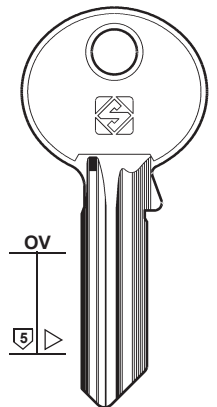
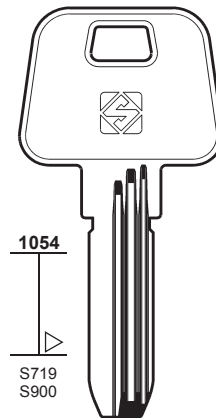
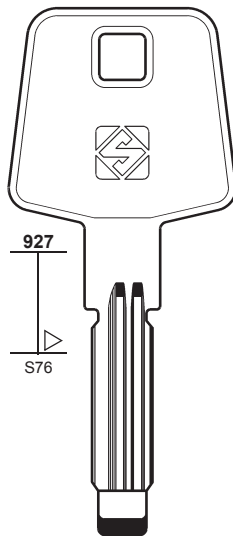
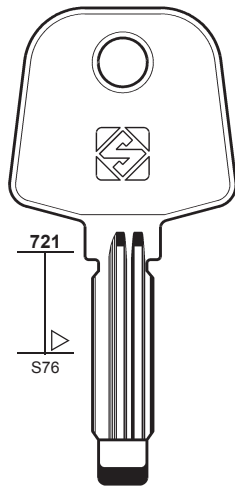

VAC91



VAC103



VAC104



VAC105



VAC150  
V6



VAC151



RADIAL



RADIAL



LAPERCHE

PER:  
FOR:

### VACHETTE

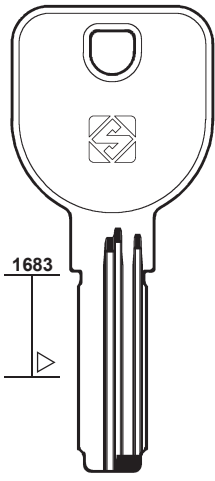

1683



VAC152

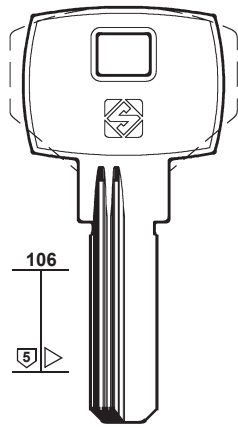

106

5



VAC153R



### VALE

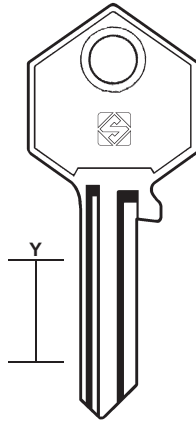

Y



VAL1

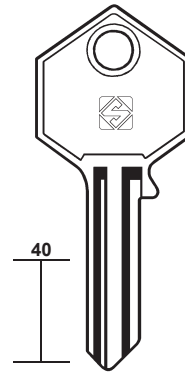

40



VAL2



# 203

#### PER / FOR

- VACHETTE (FR)
- + ISEO (108)
- + KWIKSET (119)
- + TITAN (183)
- + TOK-WINKHAUS (186)
- + VEGA (204)

- VADETO (DE)
- + BLASER (36)

VALE (TW)

VANGUARD (AR)

VAN VAULT (GB)

- VARIO (DE)
- + DOM (70)

VARIOS (ES)

VASAR (RU)

- VAUGHN (GB)
- + HTV (103)

PER:  
FOR:

### VANGUARD

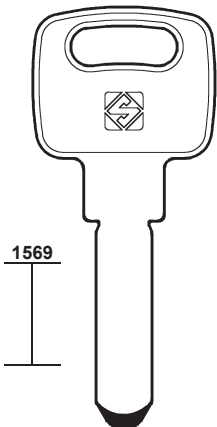

1569



VGD1



### VAN VAULT

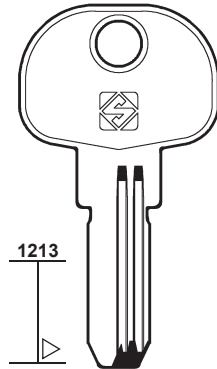

1213

1



VAV1



### VARIOS

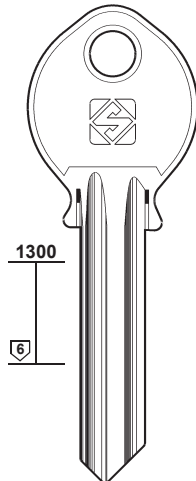

1300

6



VAR1



VAR1R

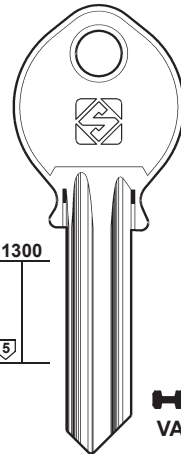

1300

5



VAR2



VAR2R



VAR5

PER:  
FOR:

### VARIOS

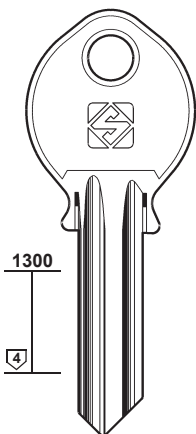

1300

4



VAR3



VAR3R

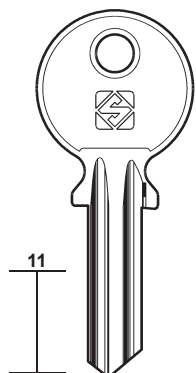

11

1



VAR4



VAR4R

### VASAR

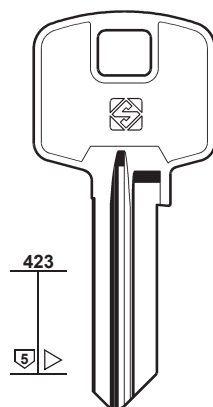

423

5



VSR1R

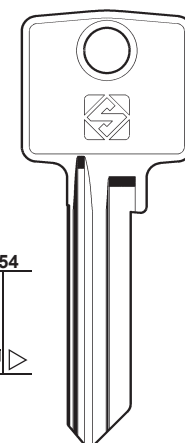

454

6



VSR2



VSR2R



# 204

### PER / FOR

#### VBH (DE)

- + FCV (87)
- + WILKA (210)

#### VDO (DE)

- + KIENZLE (117)

#### VECO (ES)

#### VEGA (FR)

#### VACHETTE

- + ANTAR (18)
- + RONIS (161)

#### VELO (TW)

- + YETI (218-219)

#### VENLOCK (VE)

- + WILSON BOHANNON (211)

#### VERA (CO)

- + SATURN (165)

#### VEROFER (RO)

#### VERSCO (DE)

- + CORBIN (60)

#### V.G.F. VILLATORE (IT)

- + P.C. CORTELLEZZI (154)

#### VIDMAR (CH)

- + SEA (166)

#### VIKI (DE)

- + DOM (70)

PER:  
FOR:

### VBH

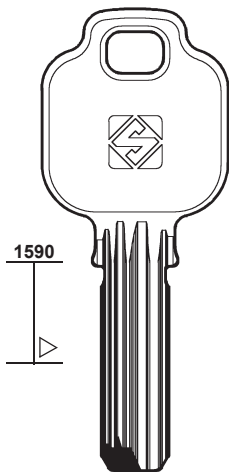

VBH1R



### VECO

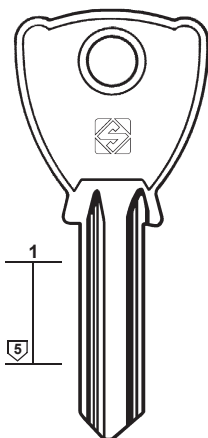

VC1



VC1R

### VEGA

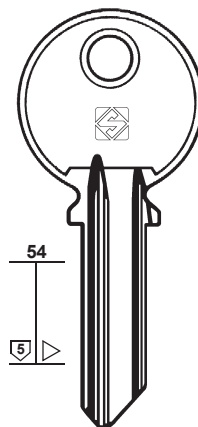

VEG1

VACHETTE

PER:  
FOR:

### VERA

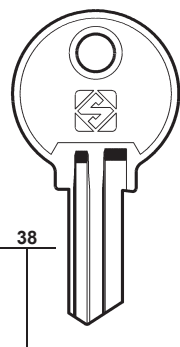

VR1

### VEROFER

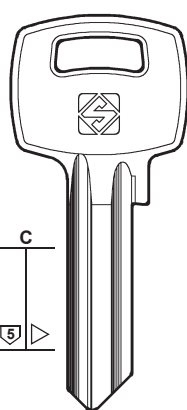

VRF3

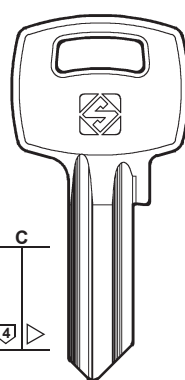

VRF4

### V.G.F. VILLATORE

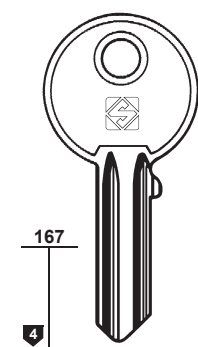

VL4



VL4R

PER:  
FOR:

### V.G.F. VILLATORE

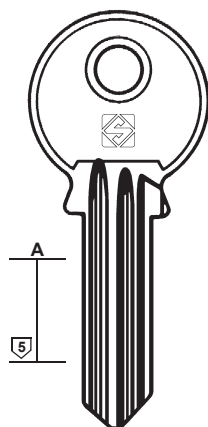

VL3



VL3R

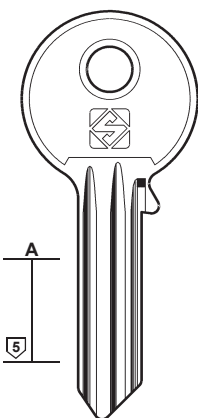

VL2



VL2R

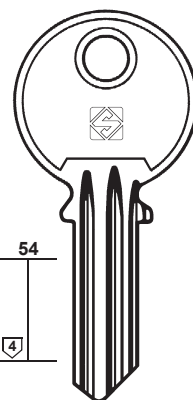

VL1



VL1R

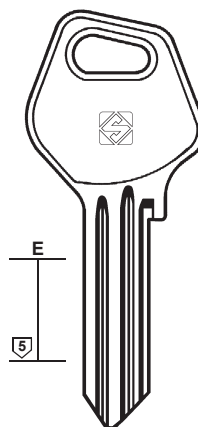

VL5E



VL5RE

PER:  
FOR:

**VINCO**

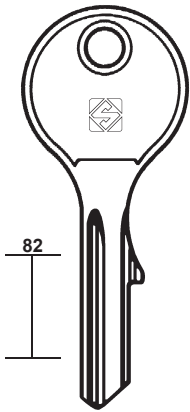

KARDEX

**VING**

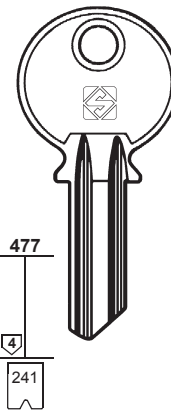
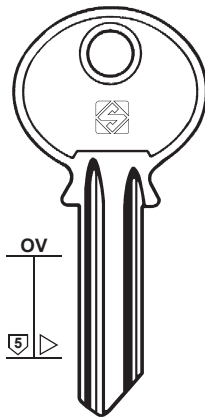
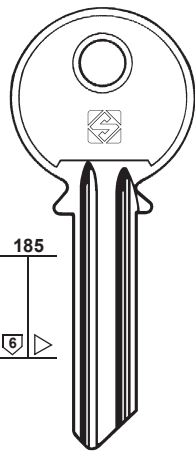

L. .... 5401-5650

NOBO



**205**

PER / FOR

**VINCO** (DE)  
KARDEX  
+ VACHETTE (198)

**VING** (NO)  
NOBO

**VIOMETAL** (FR)  
 EURO LOCKS (79)

**VIP** (FR)  
 CITY (58)

**VIRO** (IT)  
FEB  
KÖNIG  
+ ABLOY (5)  
+ ELCA (76)  
+ FAI (85)  
+ TESA (182)

PER:  
FOR:

**VIRO**

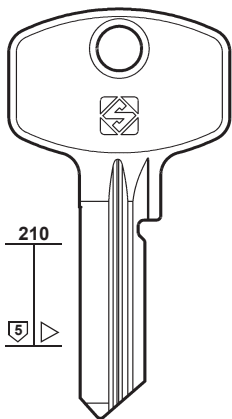

VI15R

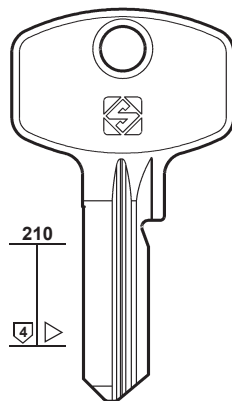

VI16R

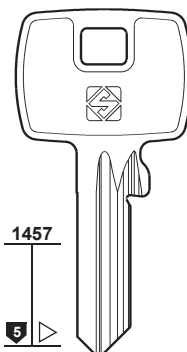

VI18R

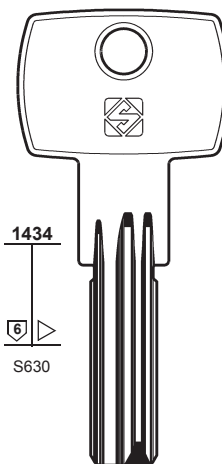

VI19  
EURO-PRO



KÖNIG

PER:  
FOR:

**VIRO**

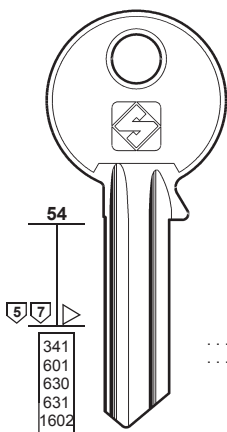

VI8



VI8R  
K



VI3



VI3R



VI5



VI5R  
TS

341  
601  
630  
631  
1602

..... 012345  
..... 6543210

..... 012345  
..... 6543210

..... 012345  
..... 01234567  
..... 012345

..... 012345  
..... 01234567

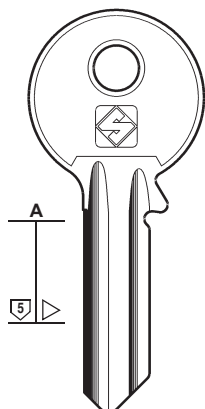

VI1  
SPECIAL



VI11R



VI6



VI12

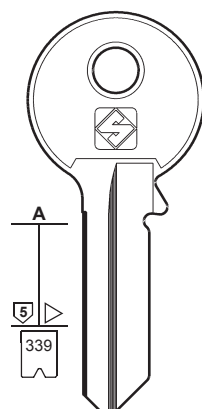

339



VI13



VI080



VI081

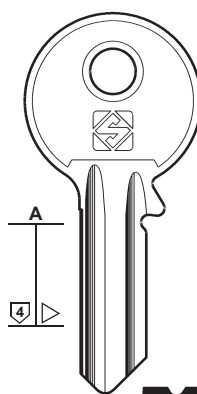

VI11  
ABT



VI9



VI9R

.....  
0-1-2-3-4-5-6



206

PER / FOR

VIRO (IT)

- ABT
- ABUS
- BERAM
- BURG
- FAI
- ROYAL
- WEISSENFELS
- + ABLOY (5)
- + ELCA (76)
- + FAI (85)
- + TESA (182)

VIS (IT)

VISO (TW)

- FORT (90)
- YETI (218-219)

VISONIC (TW)

- ALPHA (16)

VJATKA (RU)

VÖGEL (CH)

- BAAL (28)

VOKO (DE)

- CES (47)
- DOM (70)
- JOWIL (110)

VOLGOGRAD (RU)

VOLKOVYSK (RU)

PER:  
FOR:

VIRO

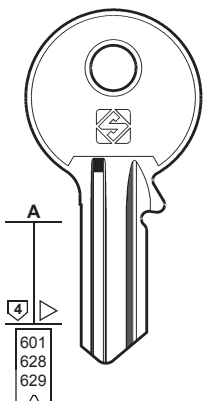

VI2

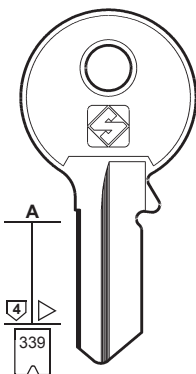

VI2R

0-1-2-3-4-5-6



VI10

0-1-2-3-4-5-6

0-1-2-3-4-5



VI10R

0-1-2-3-4-5

ABT



VI082

0-1-2-3-4-5-6



VI083

0-1-2-3-4-5-6

ABT

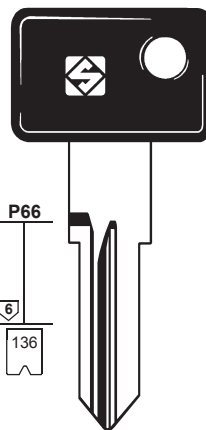

2001-3554  
8001-9554



ZD10P

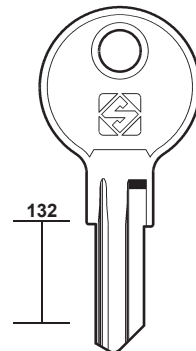

VI14

FAI

PER:  
FOR:

VIRO

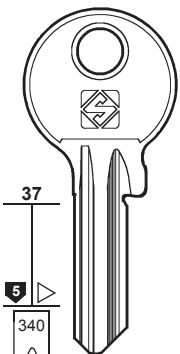

VI7



VI7R

0-1-2-3-4-5

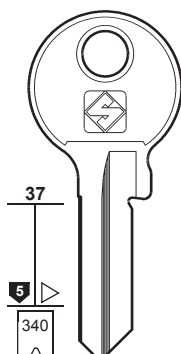

VI086



VI087

0-1-2-3-4-5

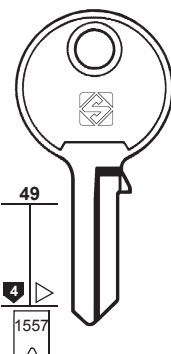

1-2-3-4-5



VI4



VI4R

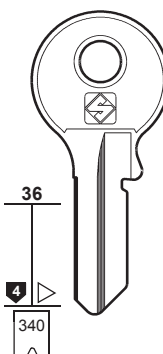

VI17



VI084



VI085

0-1-2-3-4-5

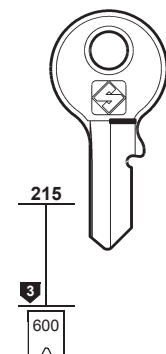

1-2-3



VI088



VI089



BERAM - ROYAL  
WEISSENFELS



BERAM - ROYAL

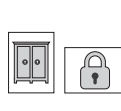

ABUS - ROYAL



ABUS - BURG  
mm 20

PER:  
FOR:

VIS

VJATKA

VOLGOGRAD

VOLKOVYSK

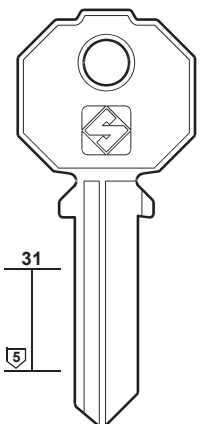

VS090V

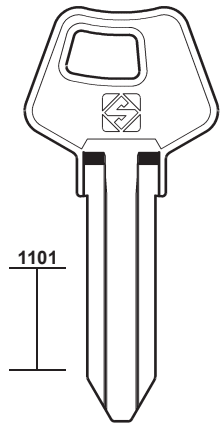

VK1



VK2

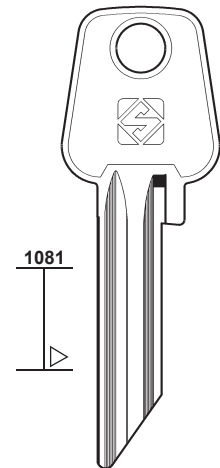

VLG1

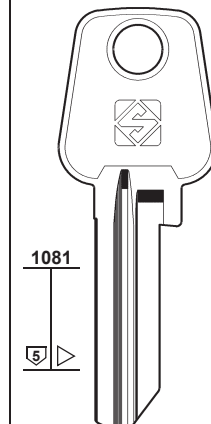

VLK1R

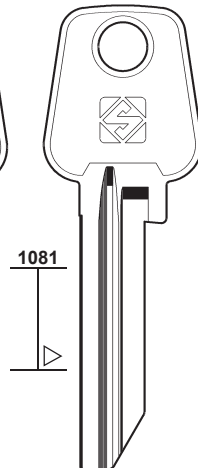

VLK2R



PER:  
FOR: **VOUGA**

**WALLY**

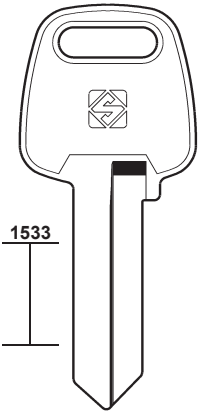

**VOG1**

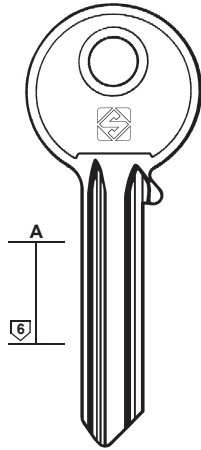
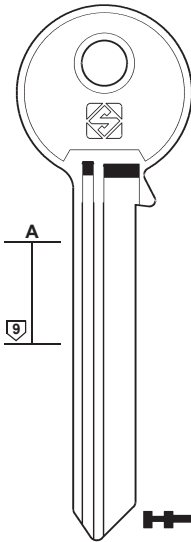

**KK1**

**WA6**

**WA6R**

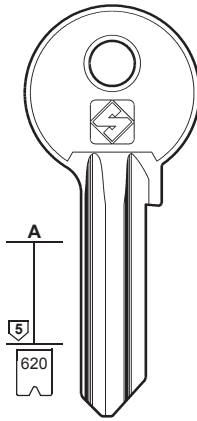

**WA1**

**WA1R**

1-2-3-4-5-6-7-8

**MOREAUX**

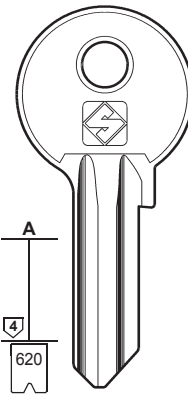

**WA2**

**WA2R**

1-2-3-4-5-6-7-8



**207**

PER / FOR

**VOUGA (BR)**

**VS (DE)**

JUNIE (111)

**WALE (TW)**

YALE (214)

**WALLY (IT)**

AKKA

MOREAUX

**WANGGUAN (TW)**

**WANJIN (CN)**

HOOPLY

**WASA-IVANA (PL)**

**WASO (DE)**

CES (47)

TRELOCK (188)

PER:  
FOR:

**WALLY**

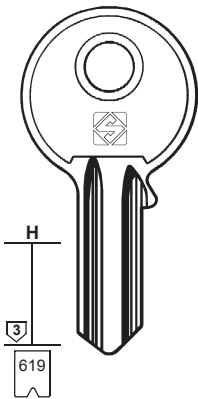

**WA7**

**WA7R**

1-2-3-4-5-6-7-8

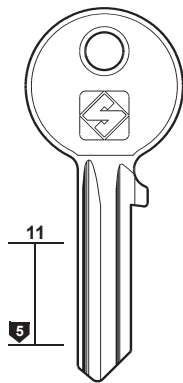

**WA3**

**WA3R**

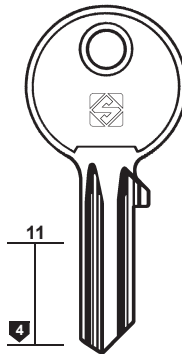

**WA4**

**WA4R**

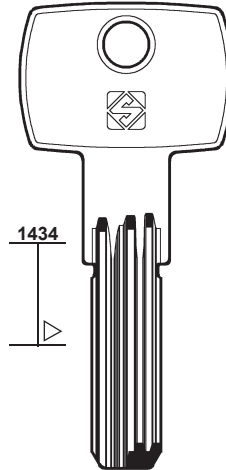

**WA8**



PER:  
FOR:

**WANGGUAN**

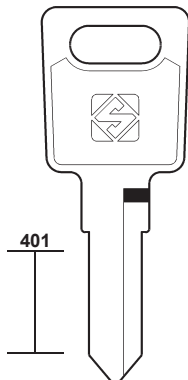

**WGU1**

**WANJIN**

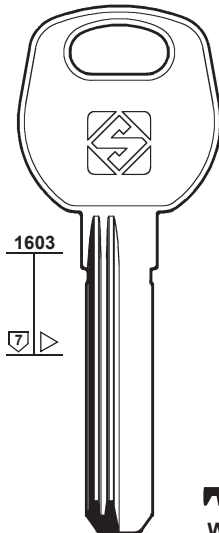

**WJ1R**



**HOOPLY**

**WASA-IVANA**

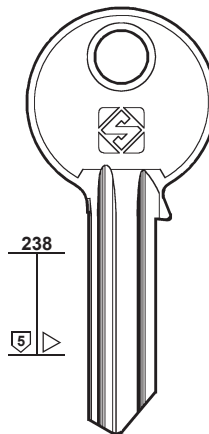

**WSA1**



# 208

PER / FOR

**WAUS** (PT)

**WB** (FR)

👁️ **KKL** (118)

**WEBER** (DE)

WECO

**WEBSTER** (GB)

**WECO** (DE)

👁️ **CES** (47)

👁️ **WEBER** (208)

👁️ **YALE** (213)

**WEISER** (US) (GB) (BE)

**FALCON**

**FICHET**

**IDEAL-SECURITY**

**KAWE**

+ 👁️ **FALCON** (85)

**WEISSENFELS** (DE)

👁️ **VIRO** (206)

**WELKA** (IT)

+ 👁️ **YALE** (212)

PER: **WAUS**

FOR:

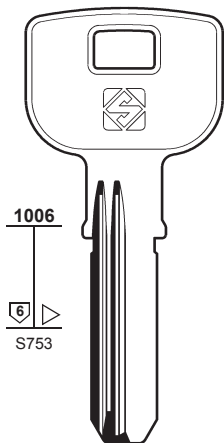

**WU1R**



PER: **WEBER**

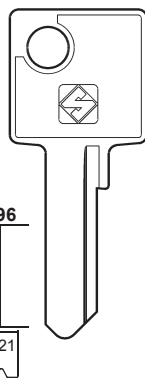

**WEB1** **WEB3**  
... 1-594  
A... 1-594



**WEB5**

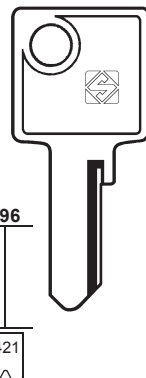

**WEB2** **WEB4**  
... 1-594  
A... 1-594



PER: **WEBSTER**

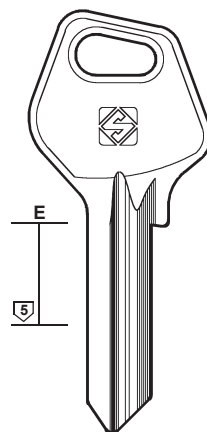

**WTR1R**

PER: **WEISER**

FOR:

PER: **WEISER**

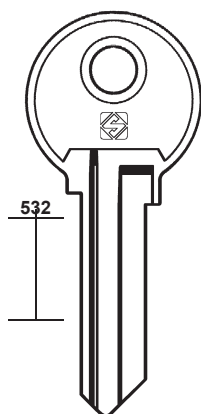

**WEI3**

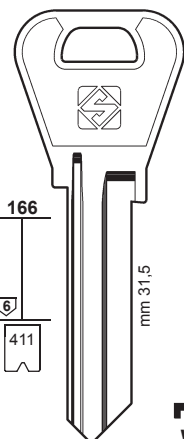

**WEI9**  
..... 0-1-2-3-4-5-6-7-8-9  
E..... 0-1-2-3-4-5-6-7-8-9

**WEI2**  
..... 0-1-2-3-4-5-6-7-8-9  
E..... 0-1-2-3-4-5-6-7-8-9

**FICHET**

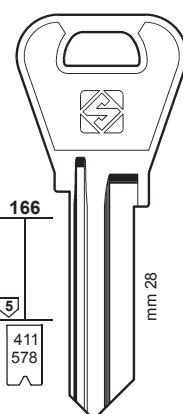

**WEI8**  
..... 0-1-2-3-4-5-6-7-8-9  
E..... 0-1-2-3-4-5-6-7-8-9

**WEI1**  
E..... 0-1-2-3-4-5-6-7-8-9  
E..... 1-2-3-4-5-6-7-8-9  
..... 0-1-2-3-4-5-6-7-8-9

**KAWE**

PER: **WEISER**

FOR:

PER: **WELKA**

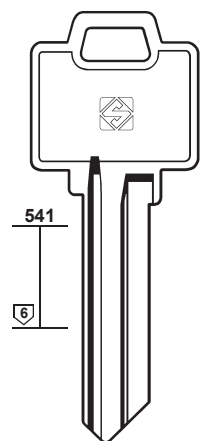

**WEI4**

**FALCON**

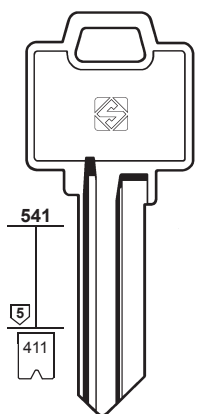

**WEI5**  
E..... 0-1-2-3-4-5-6-7-8-9  
..... 0-1-2-3-4-5-6-7-8-9

**IDEAL-SECURITY**

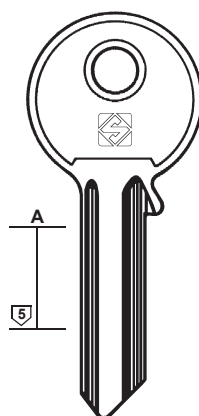

**WE5** **WE5R**

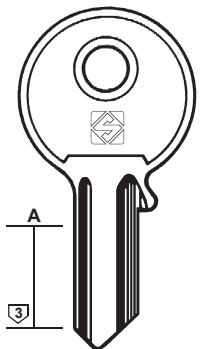

**WE6** **WE6R**

**WE16**

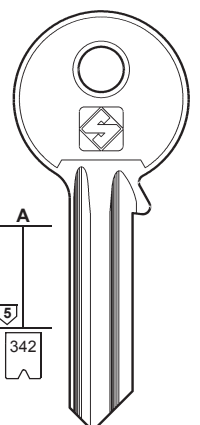

**WE1** **WE1R**  
..... 12345 ..... 012345

**WE16R**

PER:  
FOR:

### WELKA

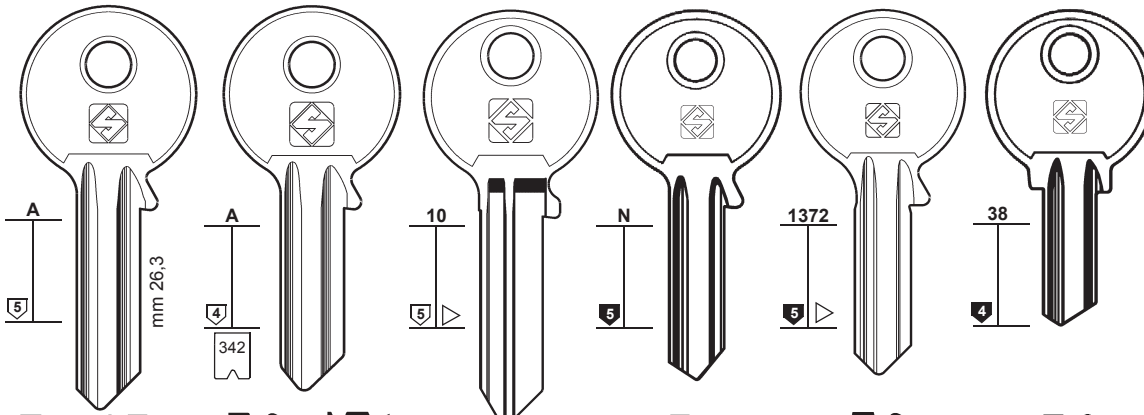

WE7 WE7R

WE2 WE2R  
... 012345

WE3

WE12

WE4

WE14 WE14R

WE15 WE15

WE8

WE3R

WE12R

WE4R

WE13 WE13R

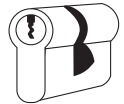

# 209

PER / FOR

WELKA (IT)  
+ YALE (212)

WEPA (DE)  
JOWIL (110)

WESCO (DE)  
KIFERM (117)  
LAS (121)

WESLOCK (US)

WEST (JP)

WFE (DE)

WHALE (IT)  
GLOBE (97)

PER:  
FOR:

### WESLOCK

### WEST

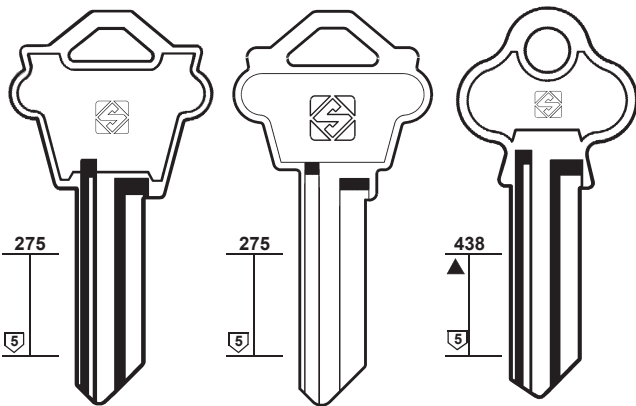

WS1

WS2

WS3

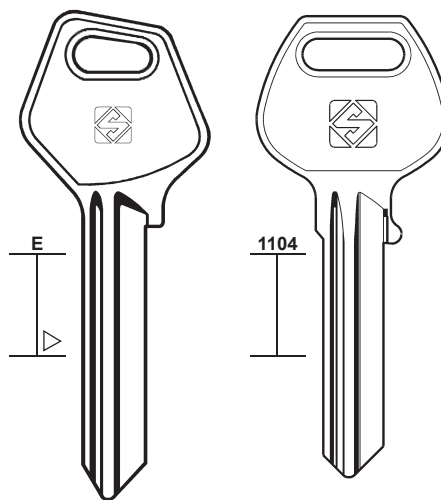

WST1

WST4

PER:  
FOR:

### WEST

### WFE

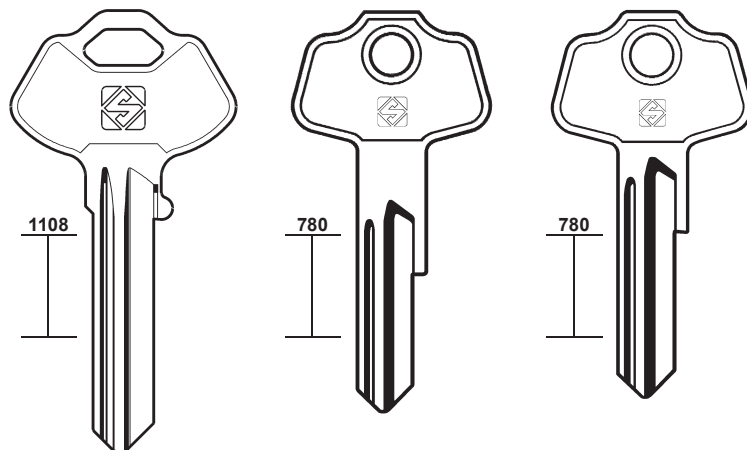

WST5

WST2

WST3

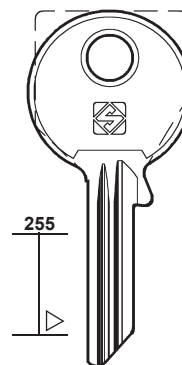

WFE1

WFE1R



# 210

PER / FOR

WHITCO (AU)

WIGRO (DE)

WILKA (210)

WILKA (DE)

CFP  
DIERRE  
DORMA  
EMKA  
GBS  
JORE  
TOP  
VBH  
WIGRO  
+ BLASER (36)

PER:  
FOR:

## WHITCO

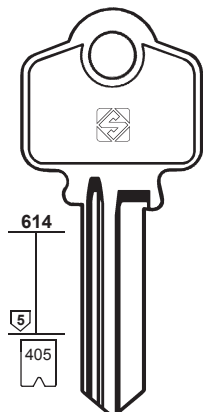

..... 0123456789A



WC1

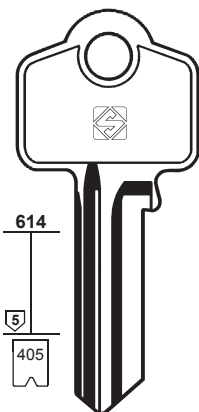

..... 0123456789A



WC2

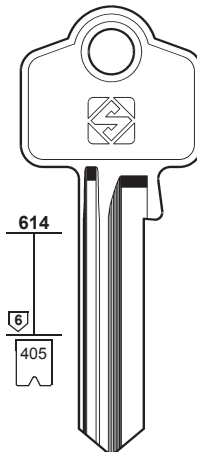

..... 0123456789A



WC3

PER:  
FOR:

## WILKA

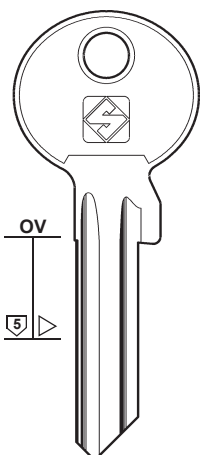

WK1X

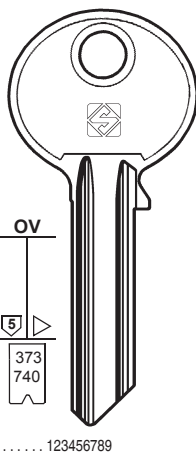

..... 123456789  
..... 400001-430000



WK1

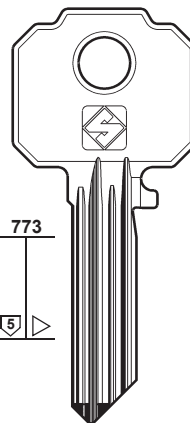

WK59R



WK49R



WK60R



WK50R



WK63R



WK51R

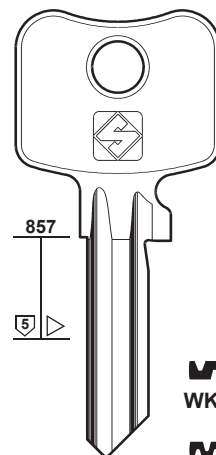

WK91R



WK69



WK68R

JORE - TOP - WIGRO

EMKA - DIERRE - DORMA - VBH

PER:  
FOR:

## WILKA

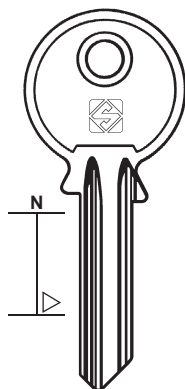

WK3

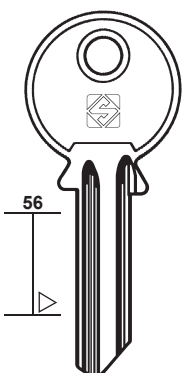

WK8



WK8R

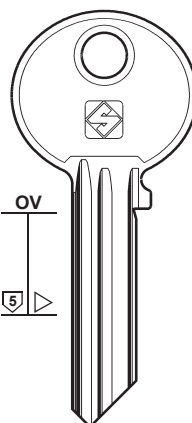

WK7



WK26



WK31



WK36



WK18



WK16



WK27



WK32



WK37



WK19



WK46



WK28



WK33



WK38



WK20



WK48



WK29



WK34



WK39



WK21



WK57



WK30



WK35



WK40



WK22



WK5

CFP - GBS

PER:  
FOR:

# WILKA

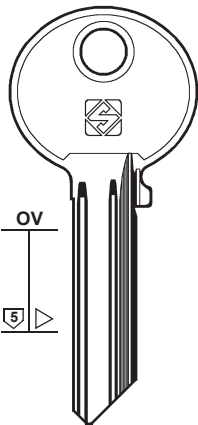

- WK6 WK4 WK9 WK2 WK2R
- WK6R WK41R WK42R WK10 WK17R
- WK25 WK15 WK14 WK45R WK47R
- WK25R WK43R WK13 WK52R WK56R
- WK44R WK53R WK12 WK62R
- WK54R WK11

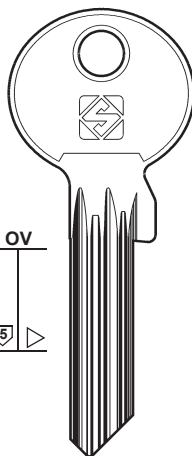

- WK45X WK71X

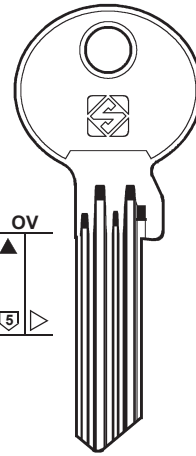

- WK87X

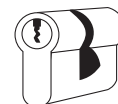

# 211

PER / FOR

**WILKA** (DE)  
+ **BLASER** (36)

**WILLACH** (DE)  
 **HUWIL** (104)

**WILLENHALL** (GB)  
 **GIBBONS** (96)

**WILSON BOHANNON** (US)  
**VENLOCK**

**WINFIELD** (TW)  
 **YETI** (218-219)

**WINFOR** (GB)  
 **MERONI** (137)

**WINKHAUS** (DE)  
 **TOK-WINKHAUS**  
(184-185-186-187)

**WINLOCK** (GB)

**WINNER** (FR)  
 **GABON** (93)

**WIREROPE** (HK)

**W.M.S.** (GB)  
I.R.  
**TITUS**  
+ **AVOCET** (26)

**WOC** (FR)  
 **YALE** (212)

PER:  
FOR:

## WILKA

## WILSON BOHANNON

## WINLOCK

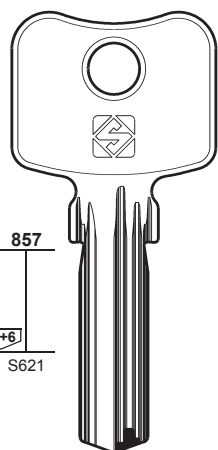

**WK70**  
.....  
10001-43000

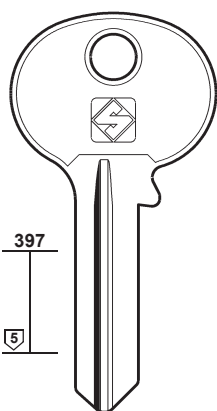

**WH1**

**VENLOCK**

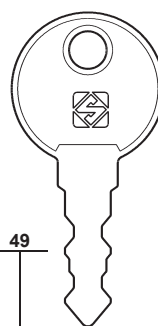

**WLC1**



PER:  
FOR:

## WIREROPE

## W.M.S.

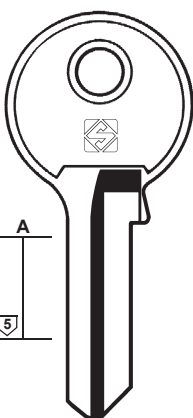

**WR1**

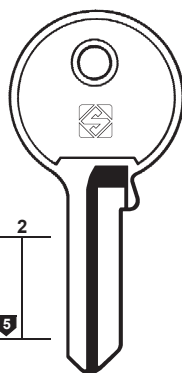

**WR2**

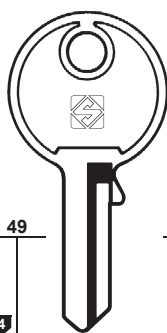

**WR3**

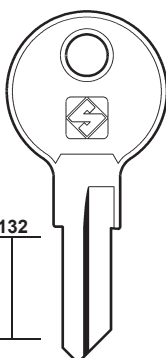

**WR4**

**WR5R**

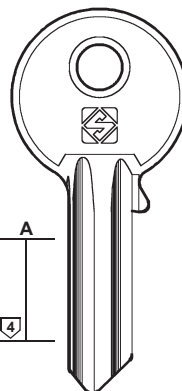

**WMS1**

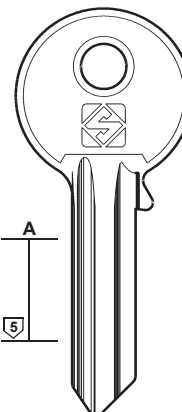

**WMS2**



I.R. - TITUS



# 212

PER / FOR

**WS** (DE)

**WÜRTH** (DE)

CORBIN (60)

HUWIL (104)

**XIEHE** (CN)

**YAC** (FR)

RONIS (161)

**YALE** (DE) (GB) (US)

BIRD

BKS

CARAT

CKS

KALE

LAREDO

PRIVE

ROC

UMF

WELKA

WOC

+ BKS (34-35)

+ HTV (103)

+ URBIS (197)

PER: **WS**

FOR:

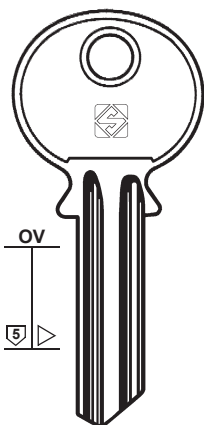

OV  
5



**WSD1 WSD1R**

PER: **XIEHE**

FOR:



49  
4



**IEH1**

PER: **YALE**

FOR:

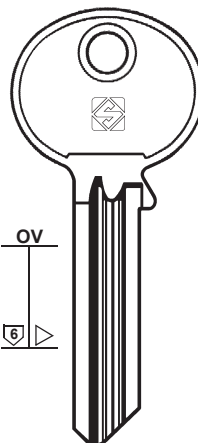

OV  
6



**YA27R**

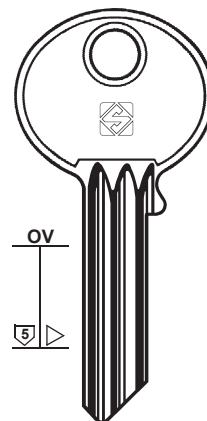

OV  
5



**YA9**

**DE GB**

**DE GB**

PER: **YALE**

FOR:

**YALE**

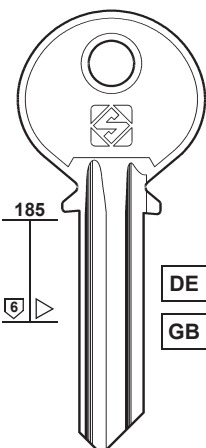

185  
5

**DE GB**



**YA5 YA5R**

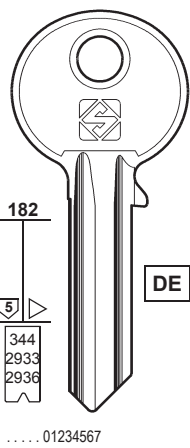

182  
5

**DE**

344  
2933  
2936

..... 01234567  
..... 0123456789  
..... 01234567890ABCDEFGHIJL



**YA1 YA1R**

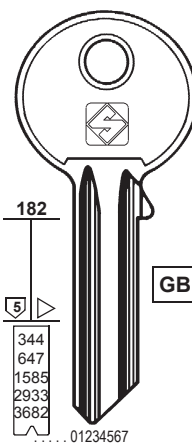

182  
5

**GB**

344  
647  
1585  
2933  
3682

..... 01234567  
..... 0123456789  
..... 01234567890ABCDEFGHIJL



**YA1E YA1ER**

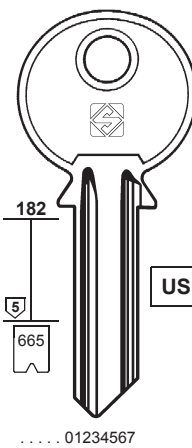

182  
5

**US**

665

..... 01234567



**YA36**

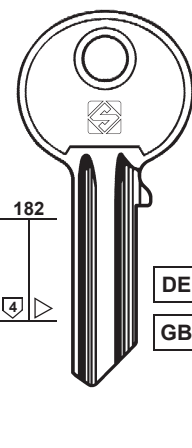

182  
4

**DE**

4

**GB**



**YA29 YA29R**

BIRD - BKS - CARAT  
CKS - KALE - LAREDO  
ROC - WELKA - WOC

PRIVE

UMF

PER: **YALE**

FOR:

**YALE**

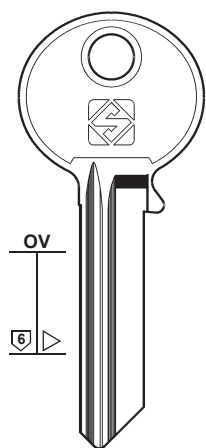

OV  
6



**YA84 YA84R**

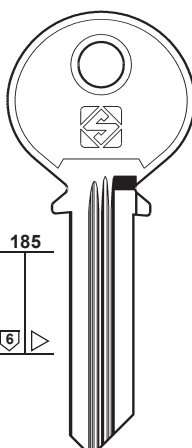

185  
5



**YA86 YA86R**

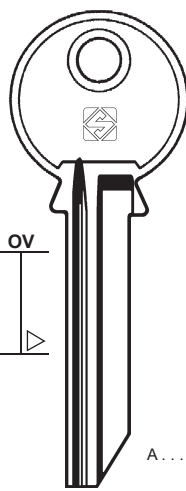

OV



**YA67**

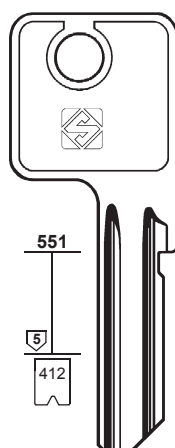

551  
5

412

A ..... 0123456789  
..... 0123456789  
..... 0123456789



**YA35**



**YA38**

..... 0123456789  
A ..... 0123456789

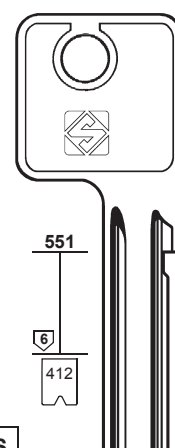

551  
6

412

**YA34**  
A ..... 0123456789  
..... 0123456789  
..... 0123456789  
..... 0123456789



**YA64 YA64R**

A ..... 0123456789  
..... 0123456789

**US**

PER:  
FOR:

# YALE

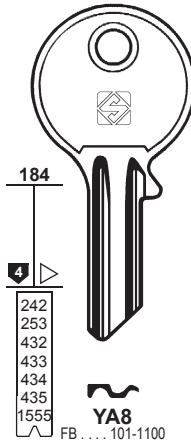
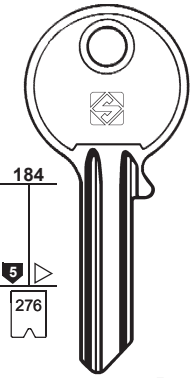
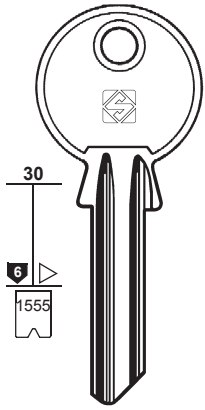

- YA8E**  
 BM...1-1000  
 KA...1-1000  
 KB...1-1024  
 AT...1-1040  
 A...1-1100  
 DB...1-1100  
 ...1-1600  
 B...1-1600  
 BS...1-1600  
 D...1-1600  
 E...1-1600  
 F...1-1600  
 IC...1-1600  
 J...1-1600  
 JA...1-1600  
 JB...1-1600  
 JD...1-1600  
 KV...1-20025  
 KD...1-4950  
 ABS...1-6000  
 D...1-750  
 R...10-101  
 KA...1001-2000  
 FB...101-1100  
 FP...101-1100  
 R...101-160  
 KV...100026-120025  
 BT...1451-2250  
 KV...20026-40025  
 CM...250-1349  
 DC...251-1350  
 FS...297-1396  
 KV...120026-140025  
 KV...40026-60025  
 FD...501-1600  
 KV...60026-80025  
 KV...80026-100025

- YA21**  
 TBS ... (AB) 401-450  
 SC ... (AB) 101-150

- YA24**  
 TBS ... (BC) 551-600

- YA22**  
 SC ... 1-50  
 TBS ... (AC) 451-500

- YA25**  
 SC ... (BC) 201-250  
 TBS ... (BD) 601-650

- YA23**  
 SC ... (AD) 51-100  
 TBS ... (AD) 501-500

- YA26**  
 SC ... (CD) 151-200  
 TBS ... (CD) 651-700

- YA15**  
 SX ... 1-1000  
 VR ... 1-4000  
 BX ... 1-500  
 VW ... 1-4000

- YA15R**

- YA8ER**



# 213

PER / FOR

- YALE** (DE) (GB) (US)  
 ABUS  
 BENDIX  
 BKS  
 CAB  
 CHICAGO  
 COLE-HERSEE  
 HUDSON  
 SOUTHC  
 SUREX  
 WECO  
 + BKS (34-35)  
 + HTV (103)  
 + URBIS (197)

PER:  
FOR:

# YALE

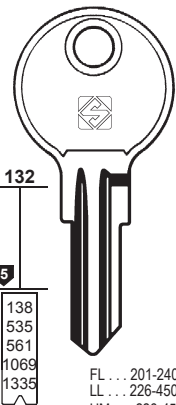
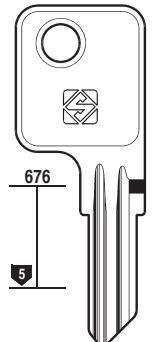
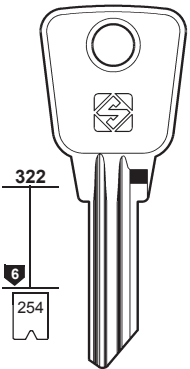
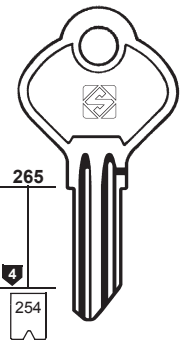

- YA66**  
 ... F8 1001-2500  
 ... F9 1001-2500

- YA68** **YA68R**

- YA69** **YA69R**

- YA20** **YA20R**

- YA19** **YA19R**  
 LT ... 1-100  
 LC ... 1-100

- YA65** **YA65R**

- YA18** **YA18R**  
 SOUTHCO  
 FL ... 201-240  
 LL ... 226-450  
 UM ... 226-450  
 ... 500-550  
 ... 600-650

- YA17** **YA17R**

- DC ... 551-952  
 TOK ... 1-99  
 RS ... T 1-99

- YA4** **YA4R**  
 HC ... 001-202  
 KC ... 251-500  
 CH ... 251-750



PER:  
FOR:

# YALE

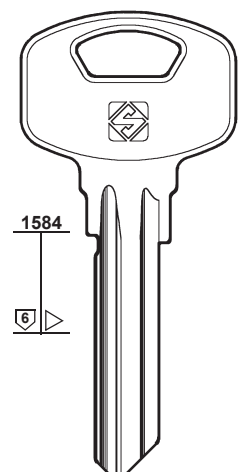
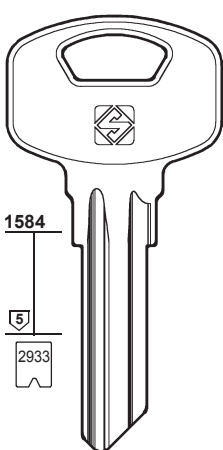
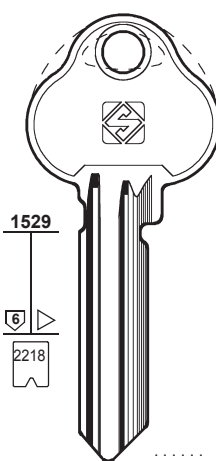
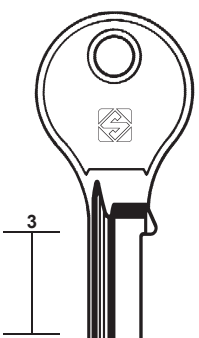
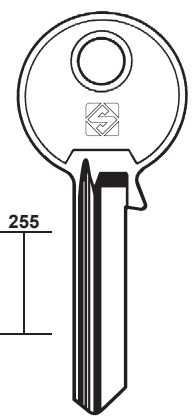

- YA16L** **YA16RL** **YA16** **YA16R**

- YA88**  
 X5

- YA89**

- YA91**

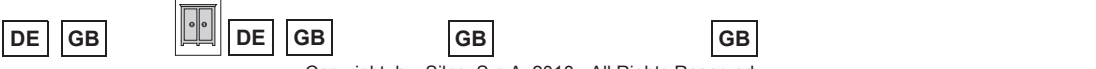



214

PER / FOR

YALE (IT) (GB)  
FERCO  
WALE

- + BKS (34-35)
- + HTV (103)
- + URBIS (197)

PER:  
FOR:

YALE

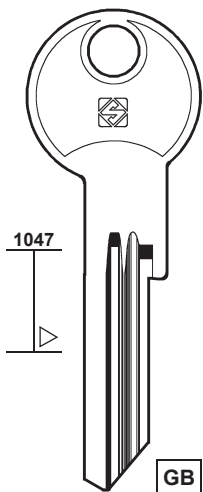

YA98R

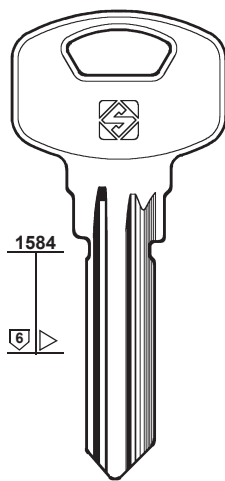

YA93

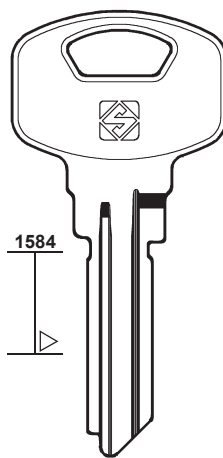

YA87  
KTM

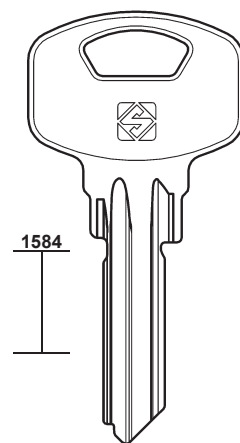

YA100

PER:  
FOR:

YALE

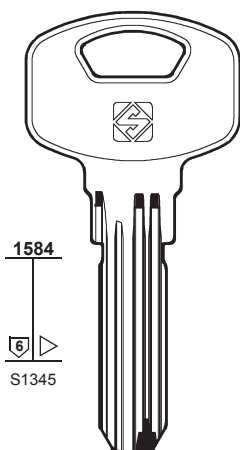

YA94  
"1000 Series"

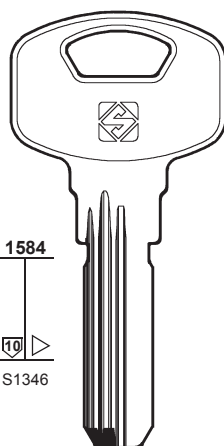

YA95R  
"2000 Series"

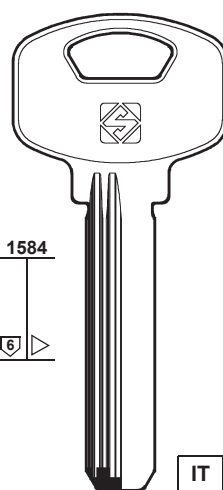

YA99R

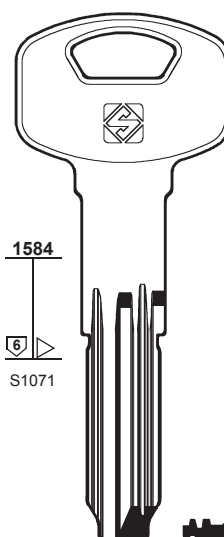

YA90

PER:  
FOR:

YALE (IT)

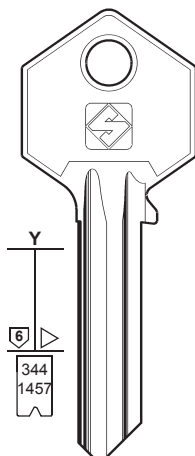

YA31 YA31R

..... 0-1-2-3-4-5-6-7-8-9  
..... 0-1-2-3-4-5-6-7-8

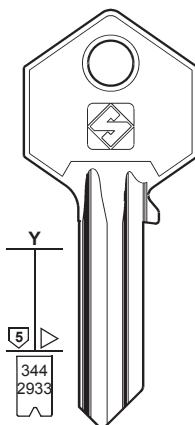

YA63  
YA226 YA227

..... 0-1-2-3-4-5-6-7-8-9

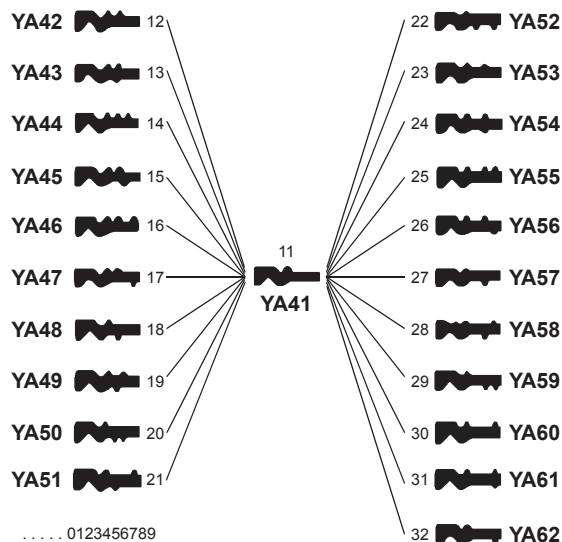

..... 0123456789  
..... 01234567890ABCDEFGHIJL

FERCO - WALE

Copyright by Silca S.p.A. 2018 - All Rights Reserved



PER:  
FOR:

### YALE (IT)

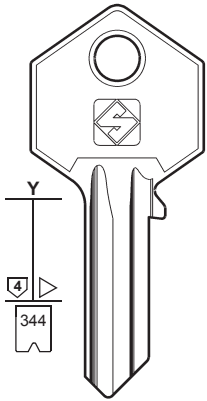

..... 0-1-2-3-4-5-6-7-8-9



YA6R



YA6

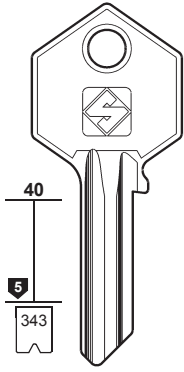

..... 1-2-3-4-5-6-7-8



YA7



YA7R



SOS - WALE

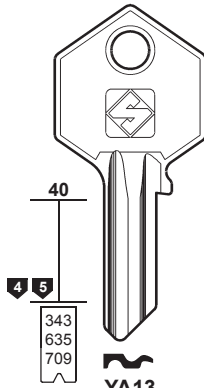

..... 1-2-3-4-5-6-7-8

YA13

..... 1-2-3-4  
..... 0-1-2-3-4-5



YA13R

..... 0-1-2-3-4-5-6-7-8



WALE

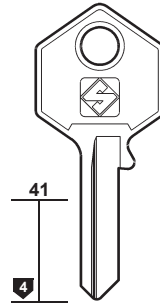

YA14

YA14R



MIGNON

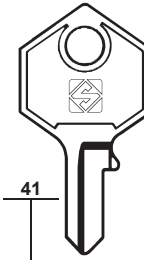

YA33

YA33R



MIGNON



# 215

PER / FOR

YALE (IT) (US)

SOS

WALE

+ BKS (34-35)

+ HTV (103)

+ URBIS (197)

PER:  
FOR:

### YALE (IT)



YA74

YA74R



MIGNON



CS28

CS28R

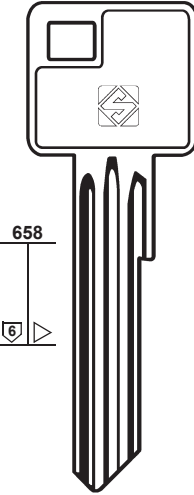

YA39

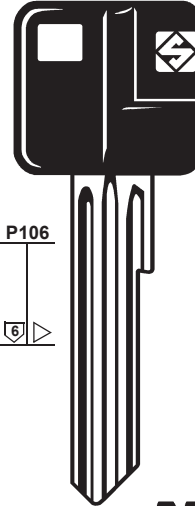

YA39P

PER:  
FOR:

### YALE

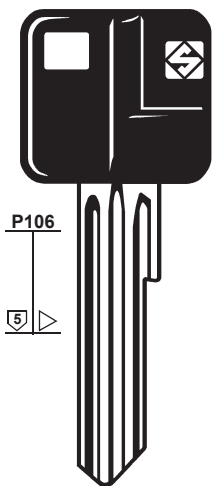

YA40P

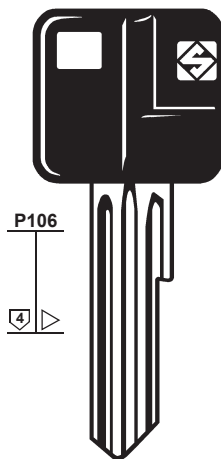

YA73P

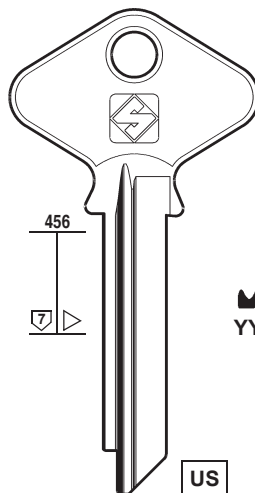

YYP7R

US

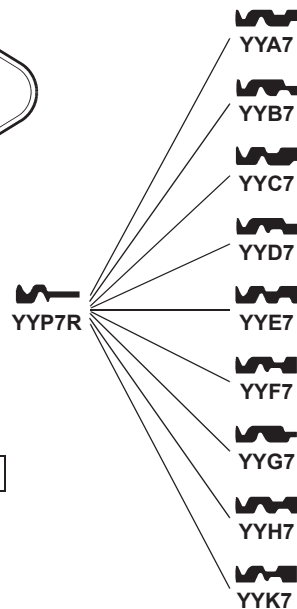



216

PER / FOR

YALE (DE) (GB) (US)  
+ BKS (34-35)  
+ HTV (103)  
+ URBIS (197)

PER:  
FOR:

YALE (US)

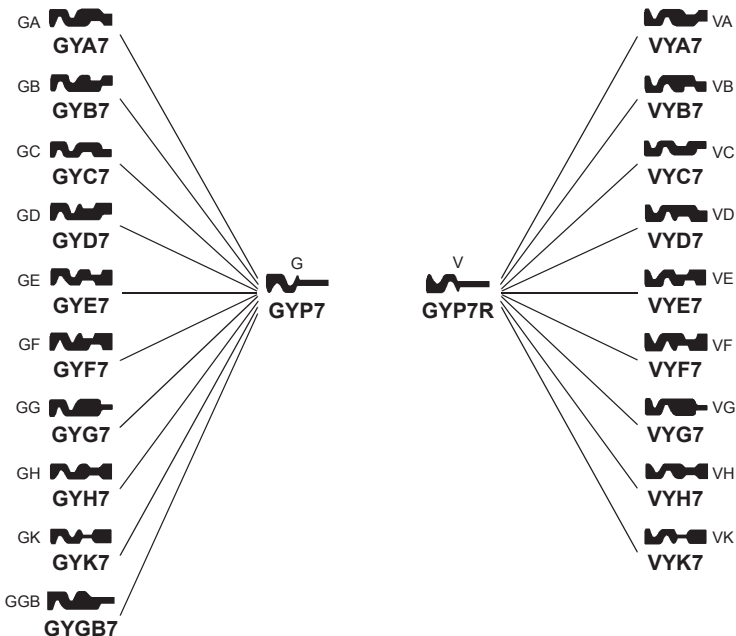
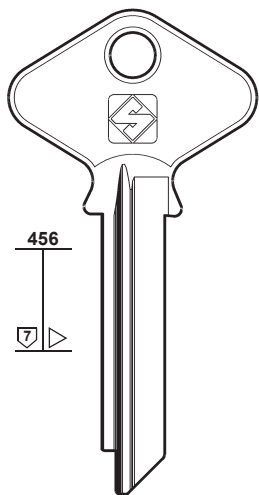

PER:  
FOR:

YALE (US)

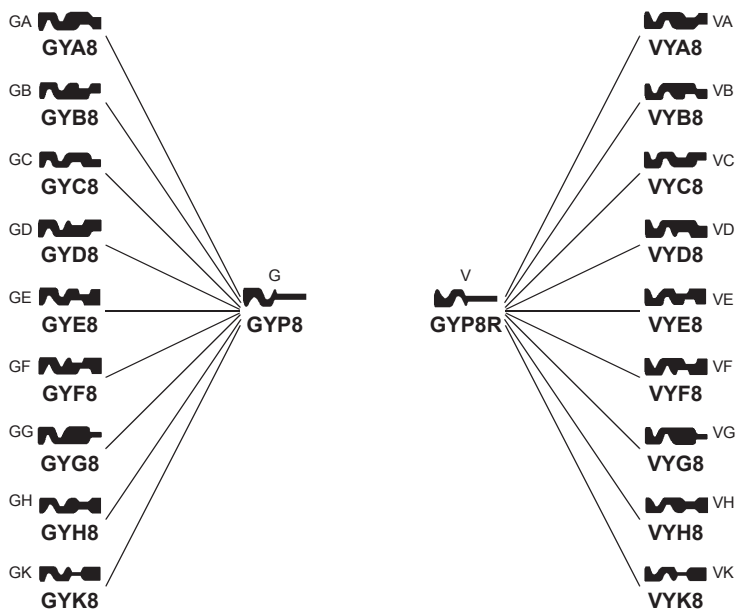
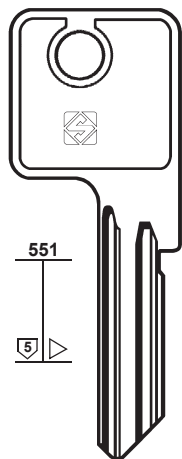

PER:  
FOR:

YALE (DE) (GB)

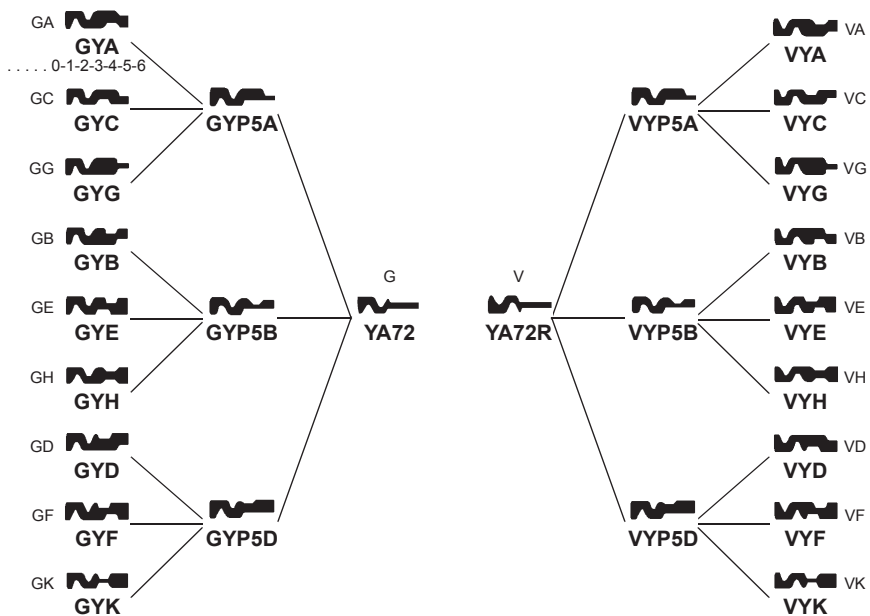
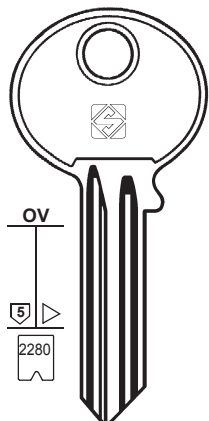

PER:  
FOR:

YALE (DE) (GB)



217

PER / FOR

YALE (DE) (GB)  
+ BKS (34-35)  
+ HTV (103)  
+ URBIS (197)

YALTRES (AR)  
+ FTH (92)

YANEDIS (GB)  
+ ETAS (78)

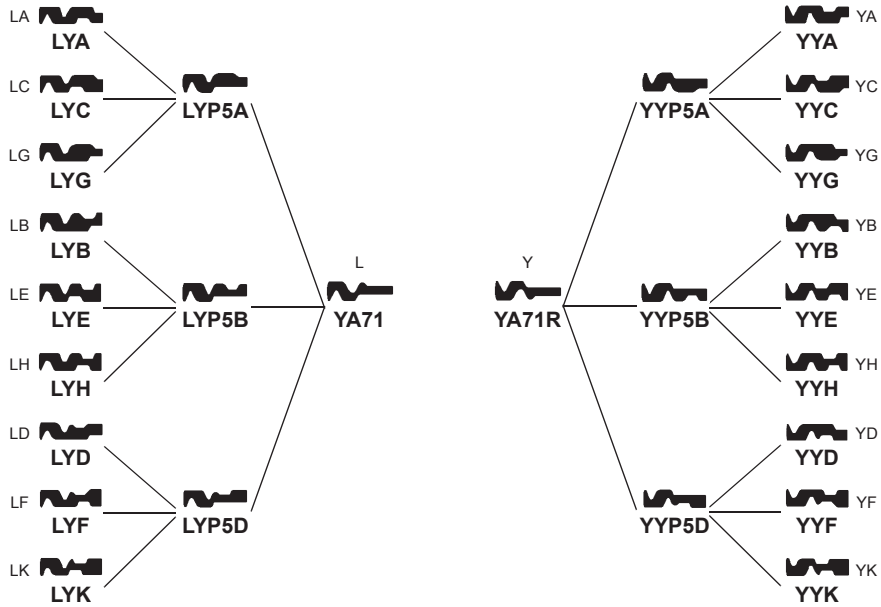
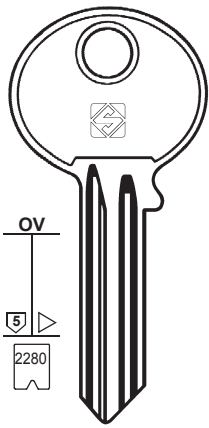

PER:  
FOR:

YALE (DE) (GB)

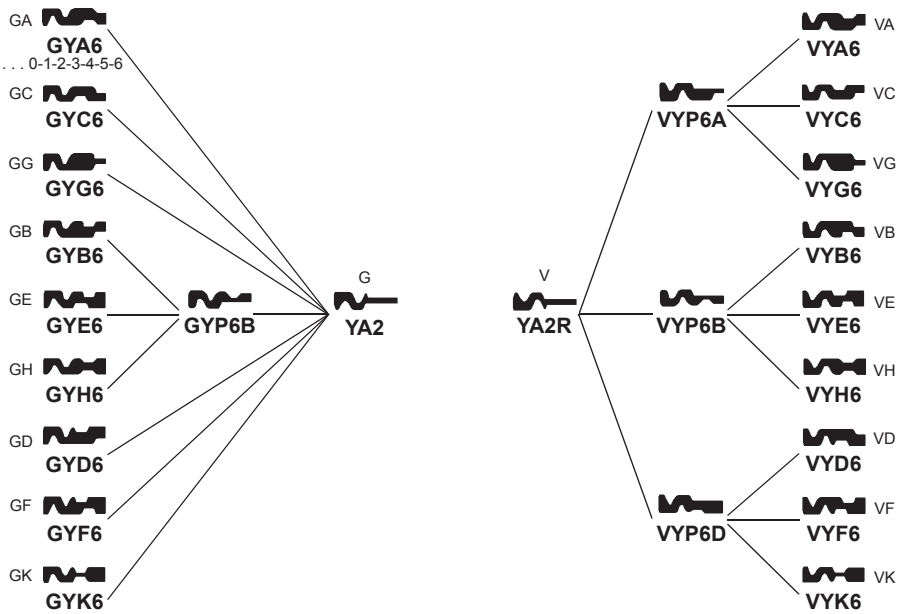
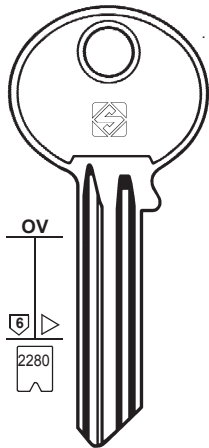

PER:  
FOR:

YALE (DE) (GB)

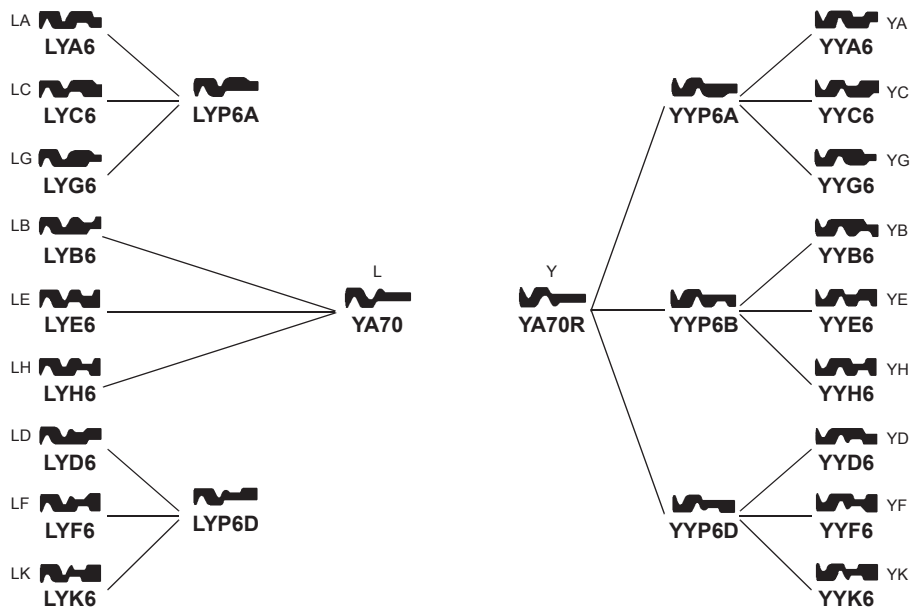
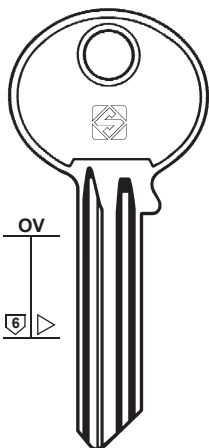



# 218

PER / FOR

YANMAR (JP)

YARDENI (IL)

YEMAR (ES)

UCEM (192)

YETI (PL)

FAB (82)

LOB (126)

MCM (134)

YETI (TW)

AKIRA  
 ASIA  
 BEDI  
 BELL  
 DEHA  
 FOUR-CIRCLE  
 HAIDE  
 HEAD  
 HEMY  
 HERMES  
 LOTUS  
 RAM  
 ROYAL  
 SANCHUN  
 SEZAN  
 SWAN  
 VELO  
 VISO  
 WINFIELD

PER: YANMAR

FOR: YANMAR

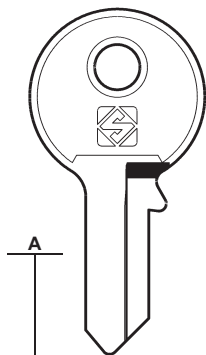

YAR1

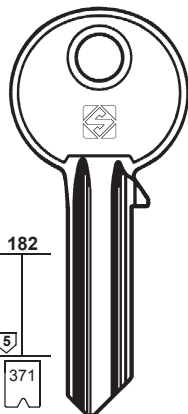

YD1



YD12



YD1R

..... 0-1-2-3-4-5-6-7-8-9

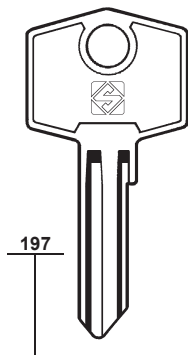

YD2



YD2R

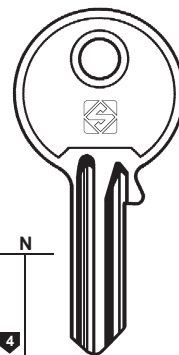

YD4



YD4R

..... 1-2-3-4-5-6

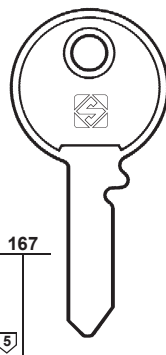

YD5R



PER: YARDENI

FOR: YARDENI

## YARDENI

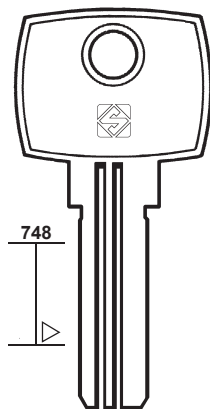

YD3R

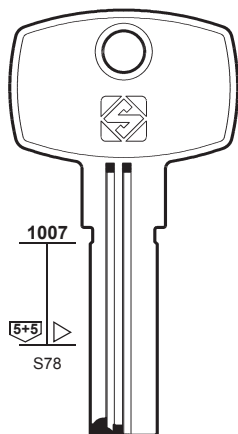

YD6R

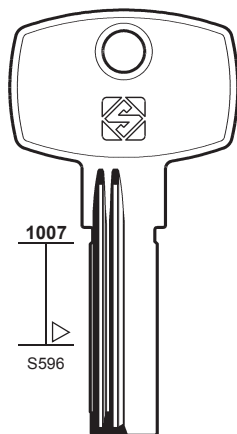

YD7R

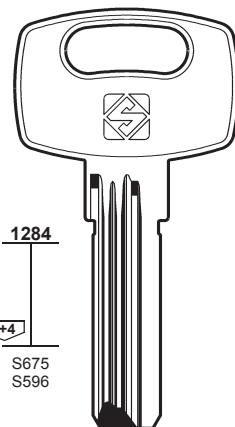

YD13R

XL



YD14R

6

PER: YETI

FOR: YETI

## YETI

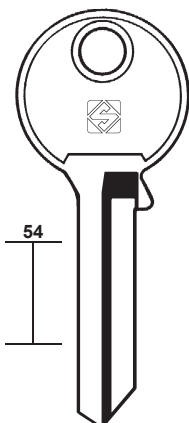

YT6



YT6R

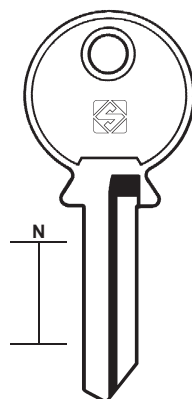

YT7



YT7R

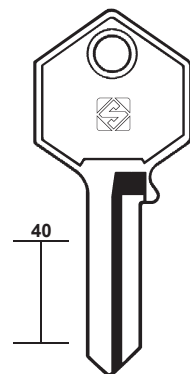

YT8



YT8R

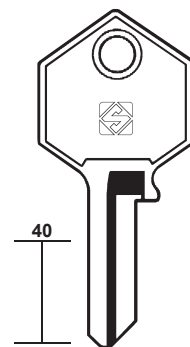

YT1



YT1R



YT12



YT12R



YT13



YT13R



YT14



YT14R



YT3



YT3R

AKIRA - ASIA - BEDI - BELL - DEHA  
 FOUR-CIRCLE - HAIDE - HEMY - HERMES  
 HEAD - LOTUS - RAM - ROYAL - SANCHUN  
 SEZAN - SWAN - VELO - VISO - WINFIELD



mm 40

PER:  
FOR:

### YETI

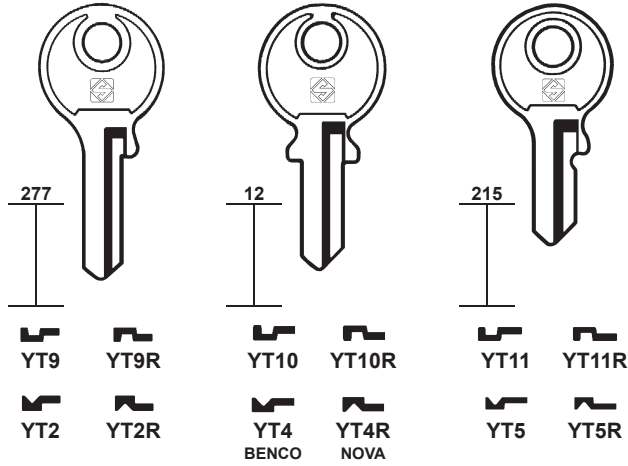

AKIRA - ASIA - BEDI - BELL - DEHA - FOUR-CIRCLE  
HAIDE - HEMY - HERMES - HEAD - LOTUS - RAM - ROYAL  
SANCHUN - SEZAN - SWAN - VELO - VISO - WINFIELD

### YUN HUAN

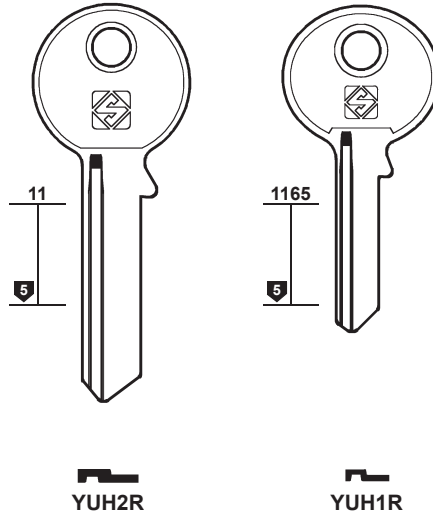

# 219

PER / FOR

**YETI (TW)**  
AKIRA  
ASIA  
BEDI  
BELL  
BENCO  
DEHA  
FOUR-CIRCLE  
HAIDE  
HEAD  
HEMY  
HERMES  
LOTUS  
NOVA  
RAM  
ROYAL  
SANCHUN  
SEZAN  
SWAN  
VELO  
VISO  
WINFIELD

**YONGTAI (TW)**  
TRI-CIRCLE (190)

**YUN HUAN (CN)**

**YVEL (FR)**  
RICOUARD (160)

**ZADI (IT)**  
BRETER (38)

PER:  
FOR:

### ZADI (IT)

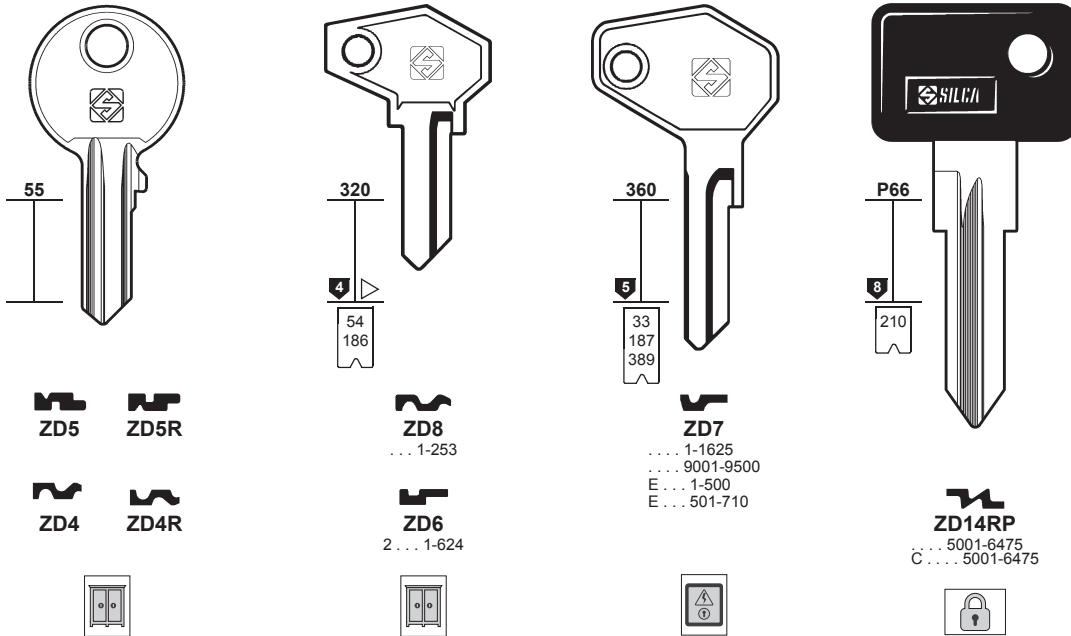

PER:  
FOR:

### ZADI (IT)

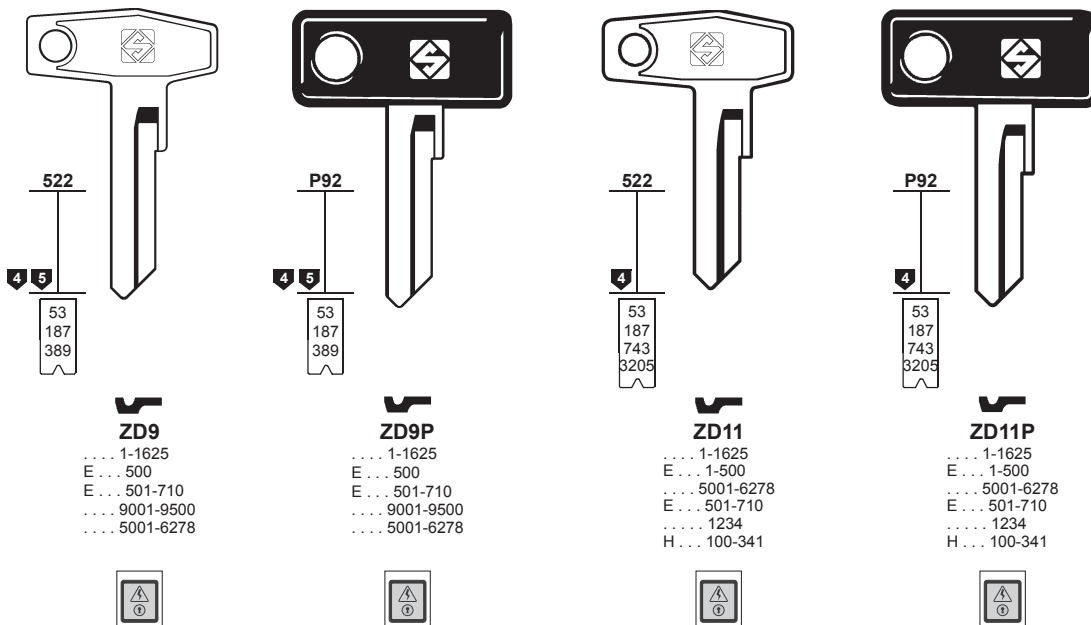



# 220

### PER / FOR

**ZADI (IT)**  
BULLOCK  
+ BRETER (38)

**ZANETTI A. (IT)**  
GHIDINI  
OB  
ROLEX  
TAUB  
TOR

**ZANI (IT)**  
BALLY  
FIC  
SINA  
ZETA  
+ ICSA (105)  
+ MORI E. (142)

**ŽEČE (HR)**  
 CORBIN (60)

**ZEISS IKON (DE)**  
BRUMME  
OTIS  
+ BAB (28)  
+ CORONA (63)

### PER: ZADI

FOR:

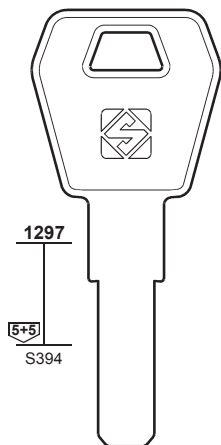

1297  
5+5  
S394



ZD25



BULLOCK

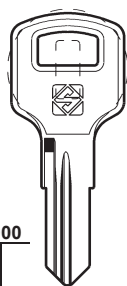

1000



ZD26R

### ZANETTI ANGELO

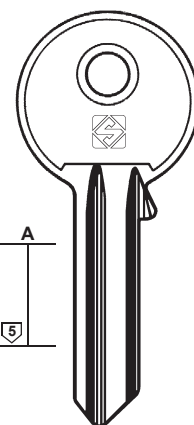

A  
5



ZA2R

GHIDINI - OB - ROLEX - TAUB - TOR

### PER: ZANI

FOR:

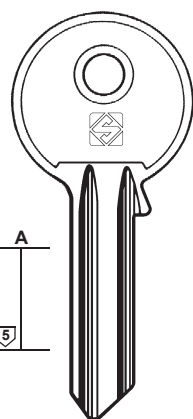

A  
5



ZI1



ZI1R

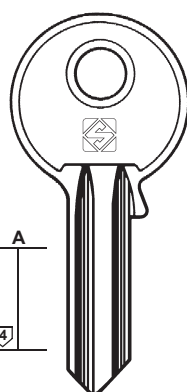

A  
4



ZI2



ZI2R

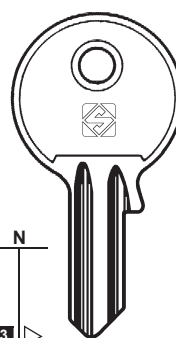

N  
3



ZI3



ZI3R

BALLY - FIC - SINA - ZETA

BALLY

### ZEISS IKON

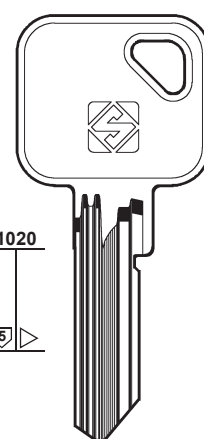

1020  
5



ZE45

### PER: ZEISS IKON

FOR:

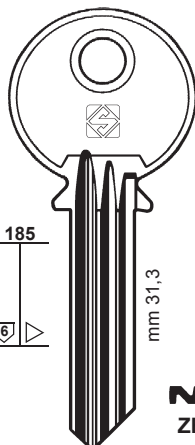

185  
6

mm 31,3



ZE42



ZE14  
ZC



ZE14R  
ZA



ZE11  
ZD



ZE11R  
ZB

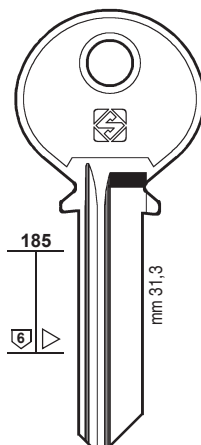

185  
6

mm 31,3



ZE46



ZE46R

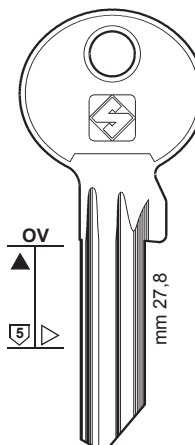

OV  
5

mm 27,8



ZE34X  
SN1



ZE34RX  
SN2



ZE39X  
SN3



ZE39RX  
SN4



ZE40X  
SN5



ZE1X  
N1



ZE1RX  
N2



BRUMME - OTIS

PER:  
FOR:

## ZEISS IKON



# 221

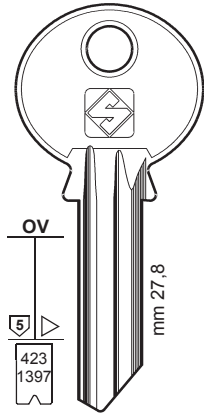

- |                      |                      |
|----------------------|----------------------|
| <b>ZE15</b><br>Z 461 | <b>ZE16</b><br>Z 484 |
| <b>ZE13</b><br>ZC    | <b>ZE13R</b><br>ZA   |
| <b>ZE10</b><br>ZD    | <b>ZE10R</b><br>ZB   |
| <b>ZE34</b><br>SN1   | <b>ZE34R</b><br>SN2  |
| <b>ZE39</b><br>SN3   | <b>ZE39R</b><br>SN4  |
| <b>ZE1</b><br>N1     | <b>ZE1R</b><br>N2    |
- ..... (TK5)  
1-2-3-4-5-6-7-8-9-0  
A-B-C-D-E-F-G-H-I-L
- ..... (TK6)  
1-2-3-4-5-6-7-8-9-0  
A-B-C-D-E-F-G-H-I-L

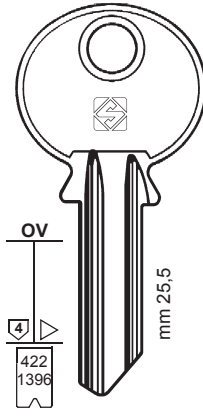

- ZE2**  
N 11
- ..... (SK5)  
1-2-3-4-5-6-7-8-9-0  
A-B-C-D-E-F-G-H-I-L

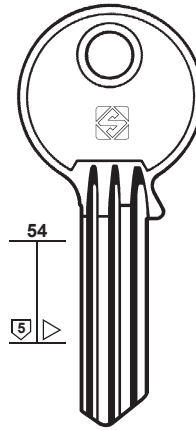

- ZE12**  
M

BRUMME - OTIS

BURG

PER / FOR

- ZEISS IKON (DE)**  
BRUMME  
BURG  
CORONA  
FORTSCHRITT  
OTIS  
+ BAB (28)  
+ CORONA (63)

PER:  
FOR:

## ZEISS IKON

ZENI (GB)

ZENICA (FR)

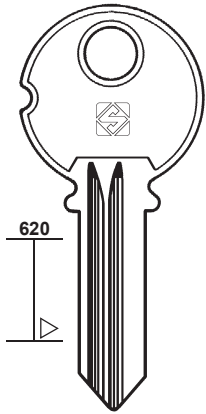

- ZE30**  
DS2
- ZE30R**  
DS1

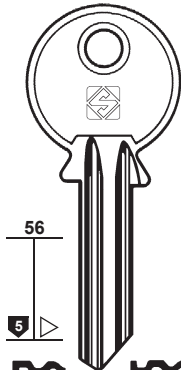

- ZE5**  
K5
- ZE4**  
K3
- ZE3**  
K1
- ZE5R**  
K60
- ZE3R**  
K2

CORONA  
FORTSCHRITT

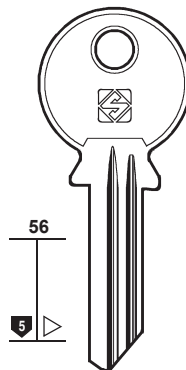
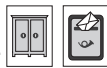

- ZE58**

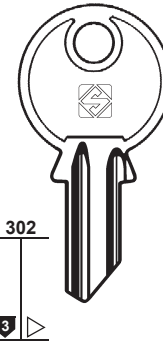

- ZE7**



PER:  
FOR:

## ZENI

## ZENICA

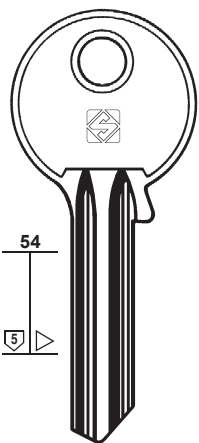

- ZN1**

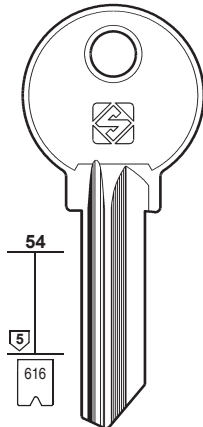

- CA14**
- CA8**  
.....  
170000-176310  
..... 0123456

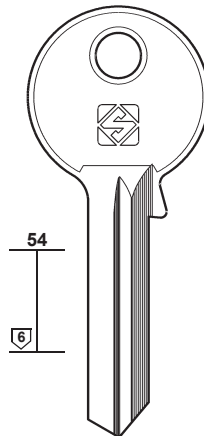

- CA13**

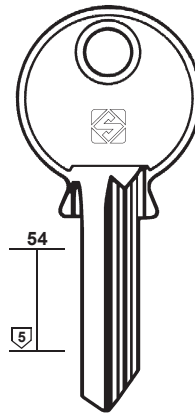

- CA12**

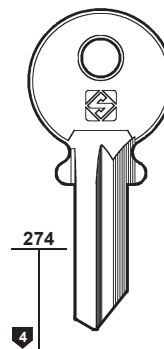

- CA6**



# 222

### PER / FOR

**ZENITH** (FR) (IT)  
 ARNOV  
 AUBERT  
 FO  
 MONOBLOC  
 QCP  
 SIAM  
 SICMA  
 + CITY (58)  
 + SIS (170)

**ZETA** (IT)  
 ZANI (220)

**ZHONGHENG** (TW)

**ZOO** (GB)

PER:  
 FOR:

## ZENITH (FR)

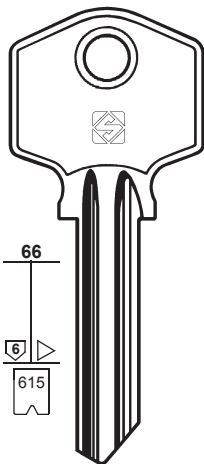

CA11

..... 0123456  
 ..... 400001-435886

AUBERT - FO

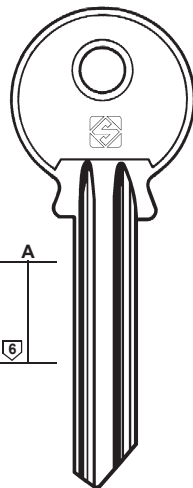

CA11R



CA10



CA10R

ARNOV  
FO - MONOBLOC

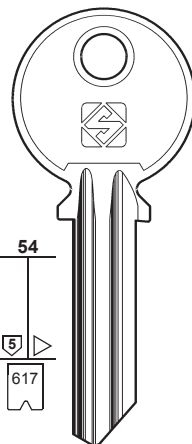

CA15

..... 81000-88179

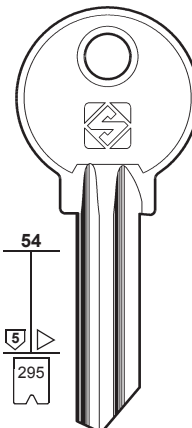

CA2R



CA2

160 ..... 000-999  
 16 ..... 1000-6288

QCP - SIAM

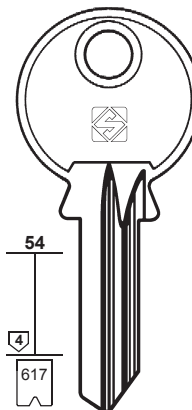

CA7

..... 0-1-2-3-4-5-6  
 ..... 12500-15949

SICMA

PER:  
 FOR:

## ZHONGHENG

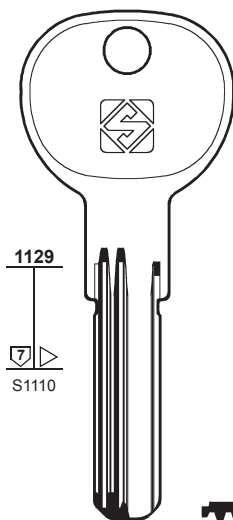

ZH1R



## ZOO

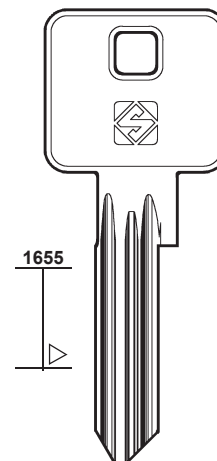

ZO1

PER:  
 FOR:





Dimple keys  
Chiavi punzonate  
Bohrmuldenschlüssel  
Clés à points  
Llaves de seguridad  
Chaves de pontos



PER:  
FOR:

**3M**

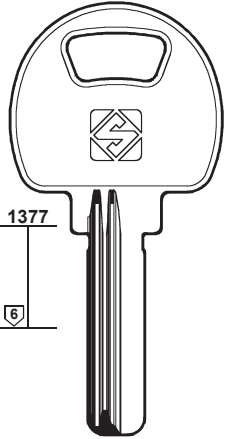

**TRM1R**

**ABUS**

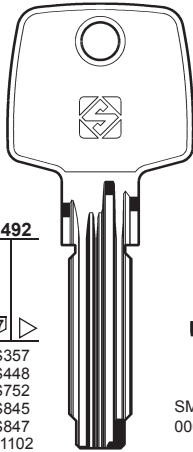

**AB84**

**EC550**

SM .....  
00001-30000

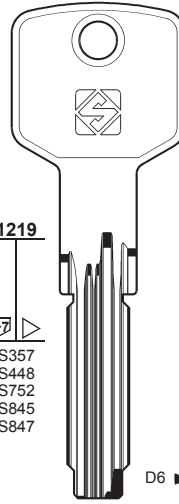

**AB48**

S357  
S448  
S752  
S845  
S847

..... 00001-38832  
..... 0001-4800  
..... (XN005710)1-38832  
..... 000001-168000



**AB74**

..... 00001-38832  
..... 0001-4800  
..... (XN005710)1-38832  
..... 000001-168000



**AB77**

**NEW ASTRAL**

PER:  
FOR:

**ABUS**

**AGA**

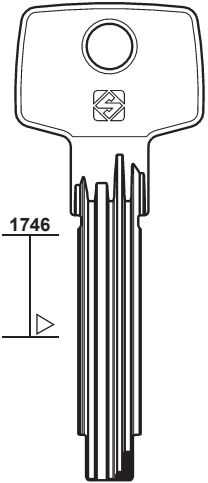

**AB109**

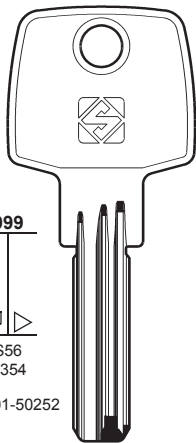

**AB40**

**AAL**

EXTRA-CLASSE

CISA - BRICARD

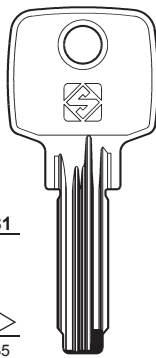

**AB62**

**EC75**

mm 30-40-50

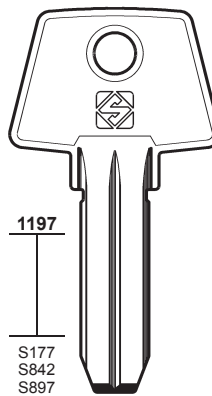

**AGA7**

S177  
S842  
S897  
S898  
S972  
..... 1-2-3-4-5

COLOMENCA - FB  
SERRALLER - TERCA

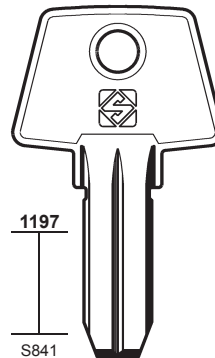

**AGA9**

S841  
S895  
S896

CASAS

PER:  
FOR:

**AGB**

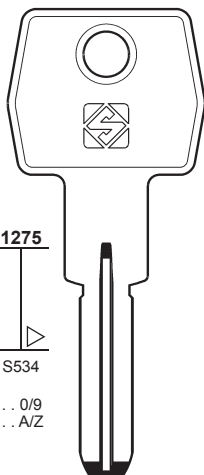

**AGB5**

SCUDO 9000

S534

..... 0/9  
..... A/Z

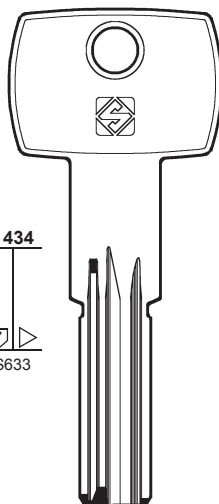

**AGB8**

S633

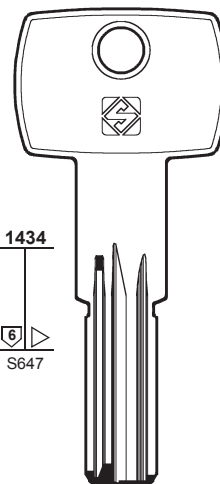

**AGB9**

S647



**225**

PER / FOR

**3M (CN)**

**ABUS (DE)**  
BRICARD  
CISA  
+ CISA (229)

**AGA (ES)**  
CASAS  
COLOMENCA  
FB  
SERRALLER  
TERCA

**AGB (IT)**



# 226

PER / FOR

AGB (IT)

AGENT (JP)

ALA (IT)

KESO (238)

AL AHRAM (EG)

ALPHA (IT)

AMIG (ES)

APEKS (RU)

ATRA (IT)

ISEO (237)

PER: FOR: **AGB** **AGENT** **AL AHRAM**

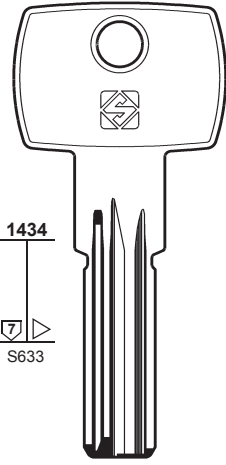

**AGB6**  
SCUDO 7000

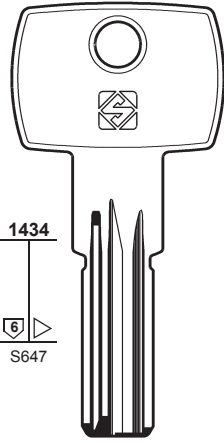

**AGB7**  
SCUDO 5000

SCUDO

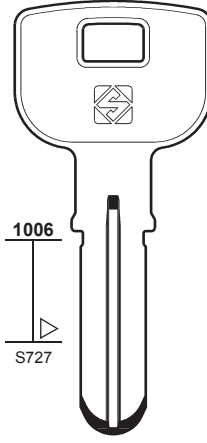

**AGN1**

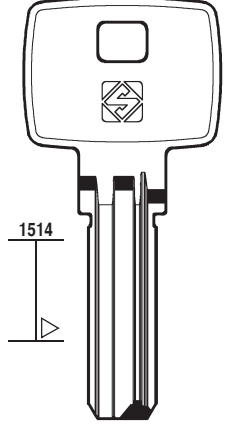

**AHR2**

PER: FOR: **ALPHA** **AMIG**

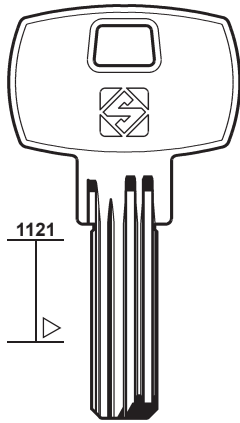

**ALP16**

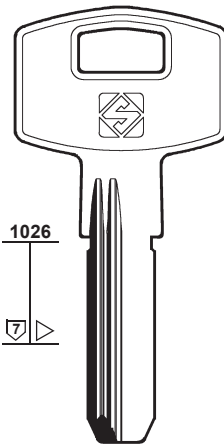

**AMG1R**

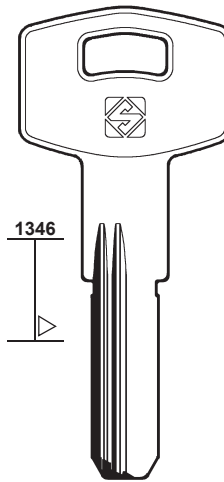

**AMG2R**

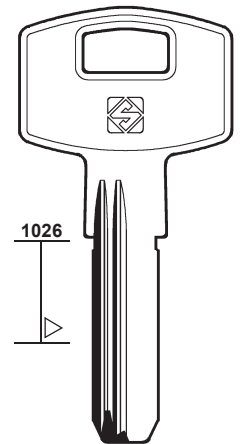

**AMG3R**

PER: FOR: **APEKS**

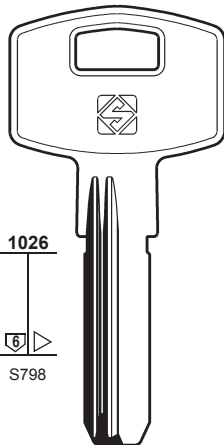

**APK2R**

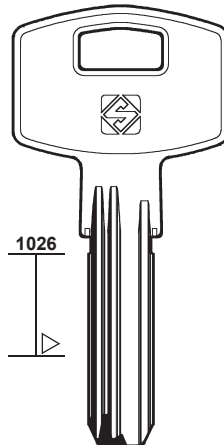

**APK3R**

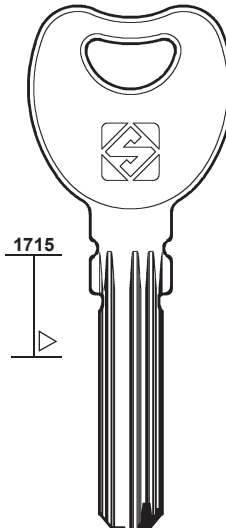

**APK4**

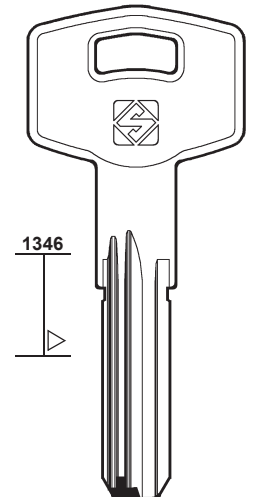

**APK5R**

PER:  
FOR: **AXA**

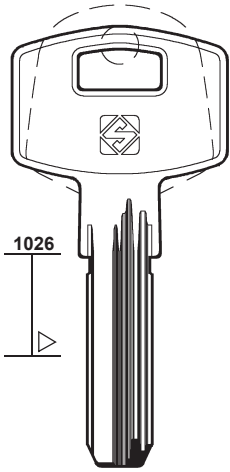

1026



**AX12**

**AZBE**

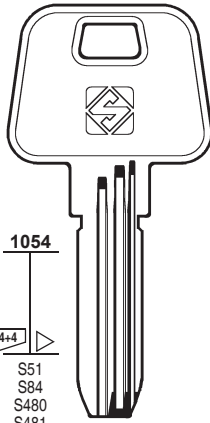

1054

5+4+4  
S51  
S84  
S480  
S481



**AZ6**  
HS-4



**AZ6R**

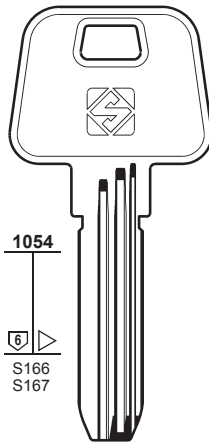

1054

6  
S166  
S167



**AZ7**  
HS-6

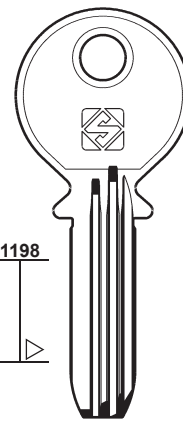

1198



**AZ8**

CAVERS



**227**

PER / FOR

**AXA** (NL)

**AZBE** (ES)  
CAVERS

**BAODEAN** (CN)  
+ CINA (229)

**BASI** (DE)  
 SATURN (244)

**BASSI** (IT)  
 GEVY (235)

**BEY** (TR)

**BKS** (DE)

**BLINKY** (CN)

**BÖRKEY** (DE)  
 KABA (237)

PER:  
FOR: **BAODEAN**

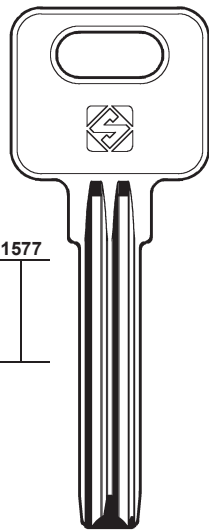

1577



**BAE1**

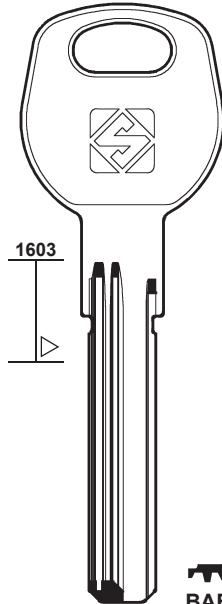

1603



**BAE2R**

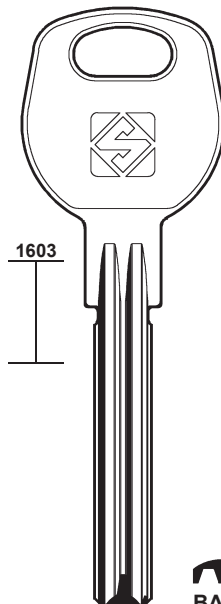

1603



**BAE3**

PER:  
FOR: **BEY**

**BEY**

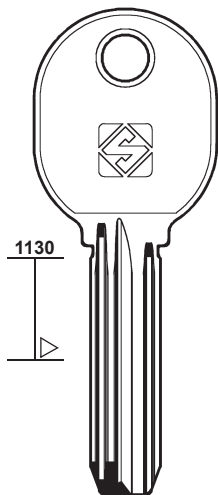

1130



**BEY1R**

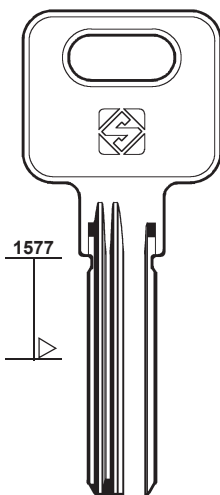

1577



**BEY2R**

**BKS**

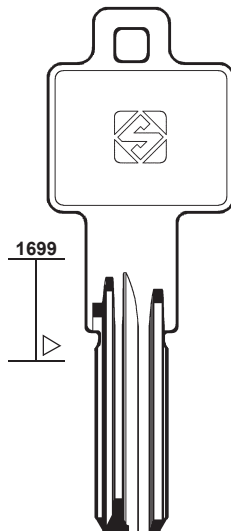

1699



**BK61**

**BLINKY**

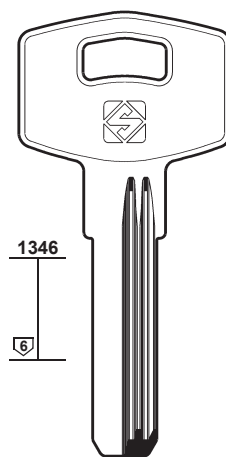

1346

6



**BNK1**



228

PER / FOR

**BRICARD (FR)**  
+ ABUS (225)  
+ CISA (229)

**BRISANT (GB)**  
HUGO

**BSS (RS)**  
URBIS (247)

**BULAT (CN)**

**BULLOCK (IT)**  
ZADI (249)

**BURG (DE)**

**CASAS (ES)**  
AGA (225)

**CAS-CISMA (IT)**  
MERONI  
SOBINCO

**CAVERS (FR)**  
AZBE (227)  
SPIDER (245)

**CAYS (ES)**

**CES (DE)**

**CIERRA SOLA (AR)**

BRICARD				BRISANT

BULAT	BURG		CAS-CISMA
	mm 30-40	mm 50-60	MERONI - SOBINCO

CAS-CISMA	CAYS	CES	CIERRA SOLA
MERONI - SOBINCO			

PER:  
FOR:

### CINA

1684  
1684  
1684  
1624

RC10R  
RC8R  
RC9R  
RC11R  
RC11  
RC15R  
RC16R

BAODEAN - HOOPLY  
MASTER LOCK - MSM



# 229

PER / FOR

CINA (CN)  
BAODEAN  
HOOPLY  
MASTER LOCK  
MSM

CISA (IT)  
ABUS  
BRICARD  
+ ABUS (225)

PER:  
FOR:

### CINA

### CISA

1603  
1603  
999  
A

RC17R  
RC14R  
S87  
S1043  
S616  
CS48  
CS70  
(W60)

A/Z A/Z A/Z .....  
000001-030198

ABUS - BRICARD  
ASIX

PER:  
FOR:

### CISA

1456  
1331  
1219

CS146  
CS144  
CS145  
CS139  
CS62  
CS115  
CS141  
CS140

S357  
S448  
S634  
S1384

..... (XN008710) 1-11808  
..... (XN005710) 1-38832  
..... 900001-944826

ASIX  
NEW ASTRAL



230

PER / FOR

CISA (IT)  
+ ABUS (225)

CITY (FR)  
+ ISEO (236-237)

CODEM (FR)  
+ FTH (234)

CODKEY (IL)  
+ SPIDER (245)

COLOMENCA (ES)  
+ AGA (225)

CORBIN (IT)  
+ DOM (231-232)

CVL (ES)

DAF (TR)

DECAYEUX (FR)  
+ PICARDIE (243)

DEFEND LOCK (CZ)

PER:  
FOR:

CISA

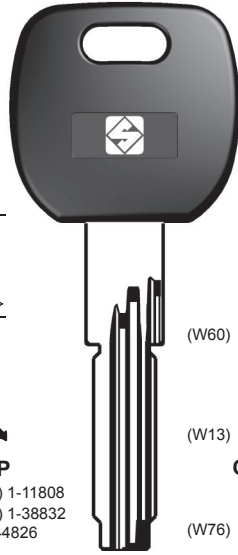

P373



S357  
S448  
S634  
S1384



CS62P

(W08) ..... (XN008710) 1-11808  
..... (XN005710) 1-38832  
..... 900001-944826



(W60) CS70P  
ASIX



(W13) CS116P



(W76) CS139P

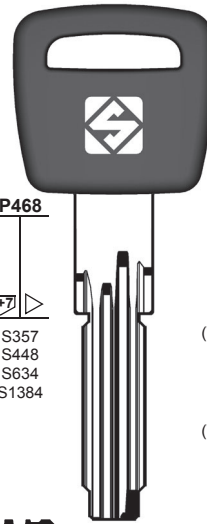

P468



S357  
S448  
S634  
S1384



CS62AP

(W08) ..... 900001-944826  
..... (XN008710) 1-11808  
..... (XN005710) 1-38832



CS155AP



CS154AP



CS159AP



(W76) CS139AP



CS158AP



(W13) CS116AP



CS157AP



(W60) CS70AP



CS156AP

PER:  
FOR:

CORBIN

CVL

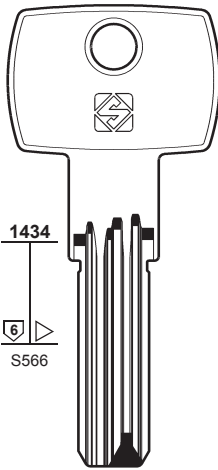

1434



S566



CB87

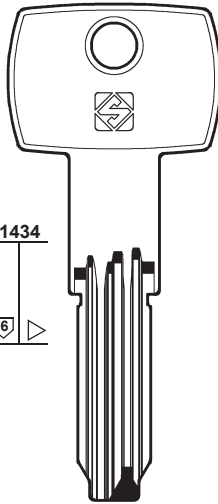

1434



S566



CB97

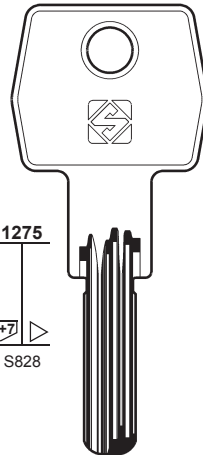

1275



S828



CB98

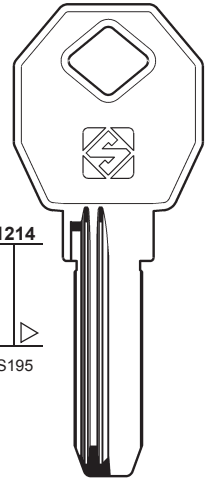

1214



S195



CVL5R

..... IC 8-7-6-5-4-3

EURO STAR PLUS

PER:  
FOR:

DAF

DEFEND LOCK

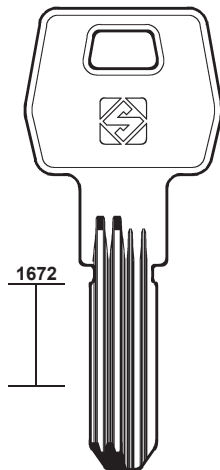

1672



DF4R

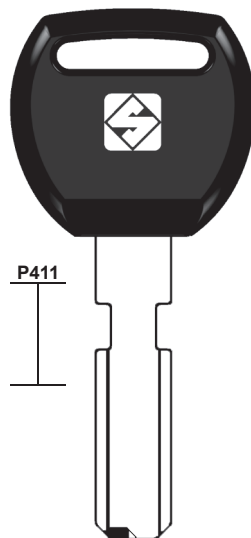

P411



DFE1RP

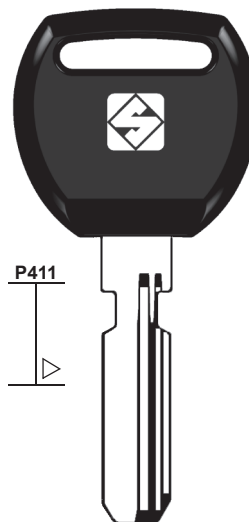

P411



DFE2P

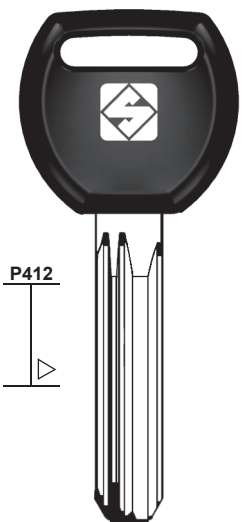

P412



DFE3RAP



PER:  
FOR:

# DEKABA

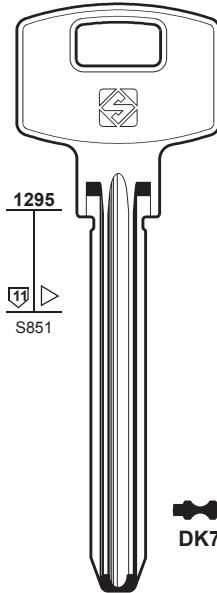
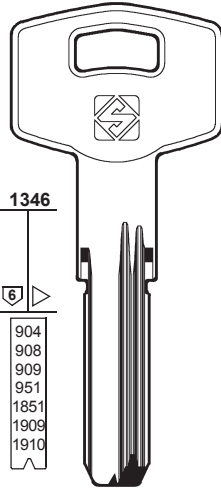
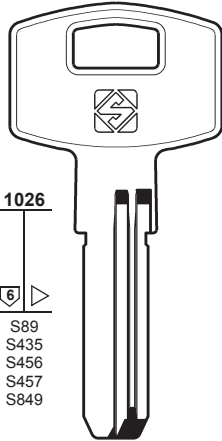
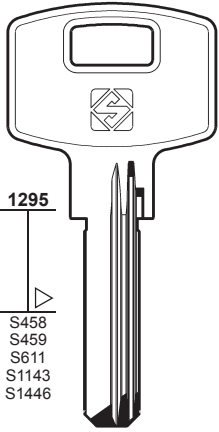

**DK1**

..... 00001-85798  
..... 000001-028000



**DK3**

E2



**DK6**

E2



**DK6X**

..... 00016-280006



**DK7**

MAUER

MAUER

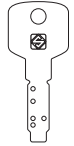

# 231

PER / FOR

**DEKABA** (BG)  
MAUER

**DELCA** (GR)  
GEVY

**DIAM** (FR)  
LAPERCHÉ (239)

**DIERRE** (IT)

**DOM** (DE)  
CORBIN  
EMHART  
IR  
LAPERCHÉ

PER:  
FOR:

# DELCA

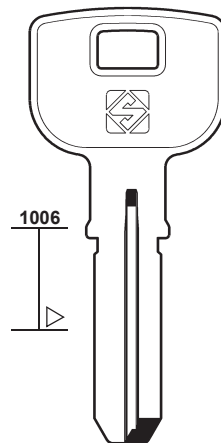
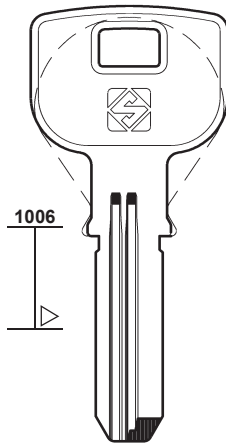
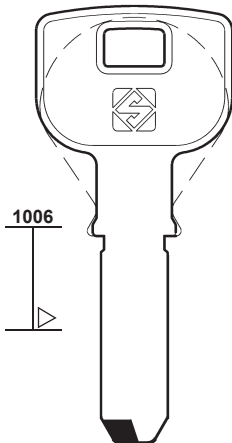
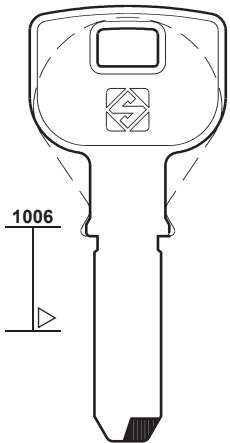

**DLC1**

**DLC1R**

**DLC2R**

**DLC3**

GEVY

GEVY

PER:  
FOR:

# DIERRE

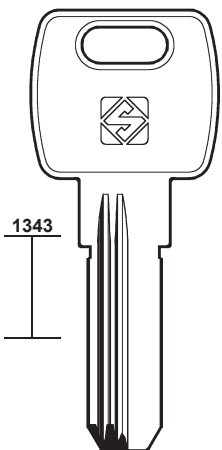

**DIR1R**

# DOM

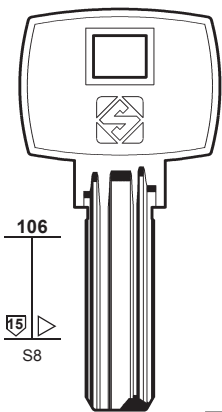

**DM64**

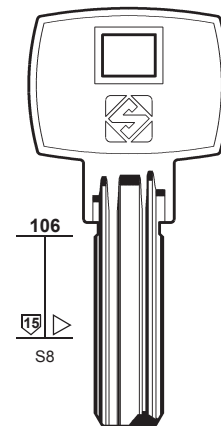

**DM120**

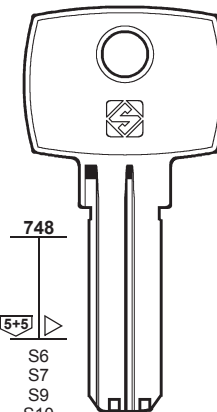

**DM49**

**DM53**

**DM118**

**DM24**

IX5

**DM122**

CORBIN - EMHART  
IR - LAPERCHÉ

CORBIN



232

PER / FOR

DOM (DE)  
CORBIN  
EMHART  
MOREAUX  
STS

DOMUS (GR)

DORSET (IN)  
KABA (237)

ELCA (DE)  
STS  
TESA  
VIRO

ELZETT (HU)

PER: DOM  
FOR:

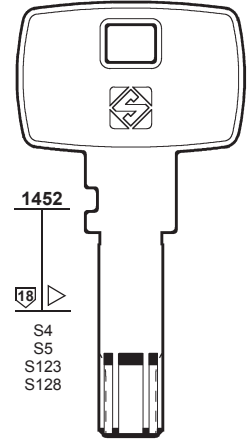
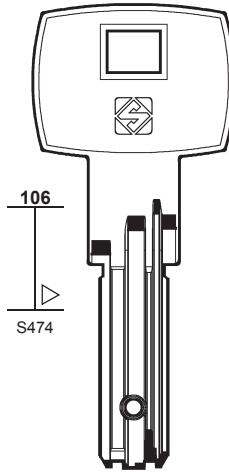
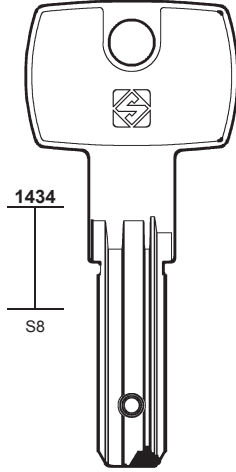

PER: DOM  
FOR:

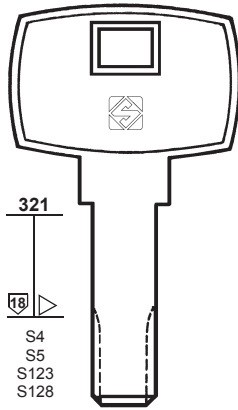

CORBIN - EMHART

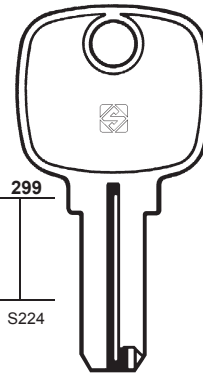

MOREAUX

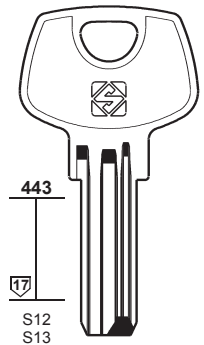

PER: DOM  
FOR:

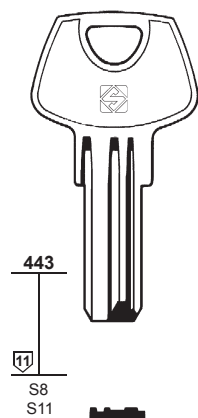

PER: DOMUS (GR)  
FOR:

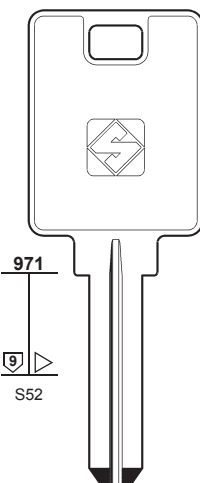

PER: ELCA  
FOR:

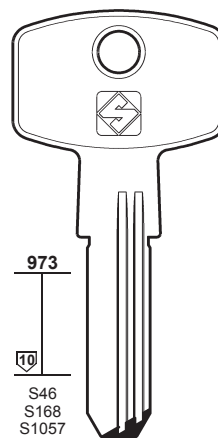

STS - TESA - VIRO

PER: ELZETT  
FOR:

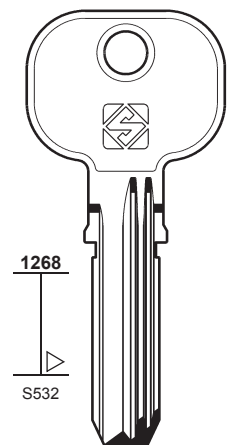

0-1-2-3-4



PER: **EURO LOCKS**  
FOR:

**EVVA**

**EZCURRA**

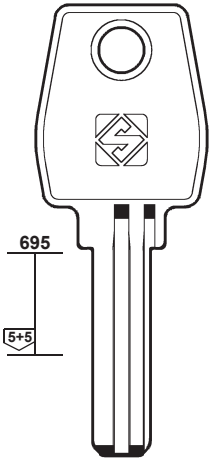

**EU17**

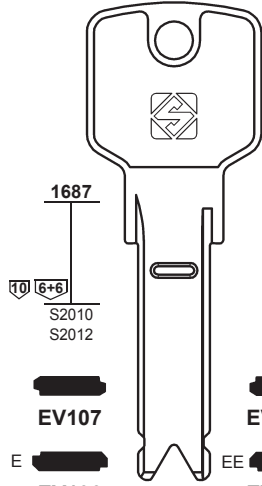

**EV107**  
**EV106**  
**EV122**

**EV107R**  
**EV106R**  
**EV122R**

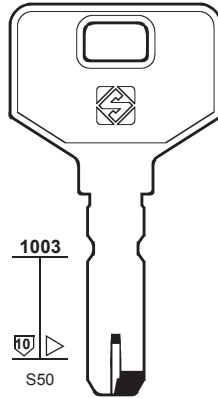

**EZ3**  
DS10

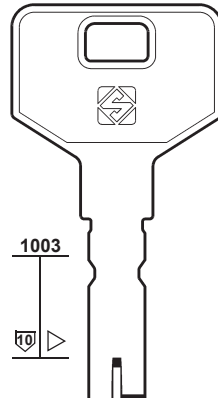

**EZ3X**  
DS10



**233**

PER / FOR

**EVVA (AT)**

**EMHART (US)**  
DOM (231-232)

**ESAFE (ES)**  
UCEM (247)

**EURO LOCKS (BE)**

**EZCURRA (ES)**  
SEA (244)

**FAC (ES)**

PER:  
FOR:

**EZCURRA**

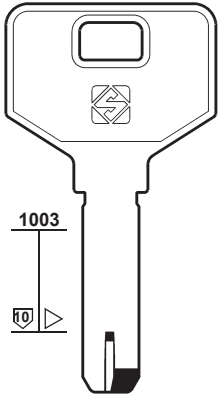

**EZ6**  
DS15

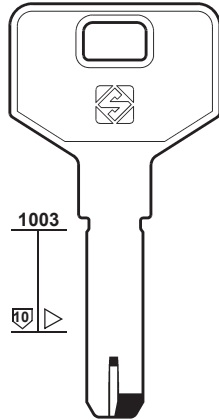

**EZ6X**  
DS15

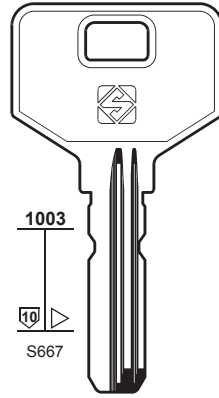

**EZ4**  
DS10-E

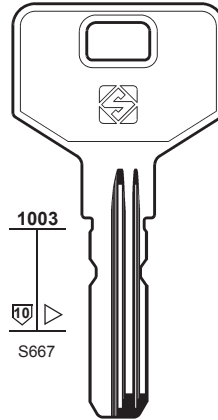

**EZ4X**  
DS10

PER:  
FOR:

**EZCURRA**

**FAC**

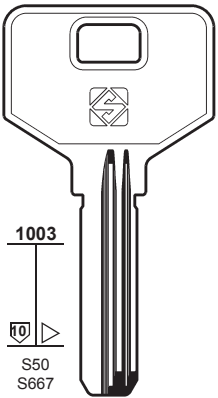

**EZ5**  
DS15-E

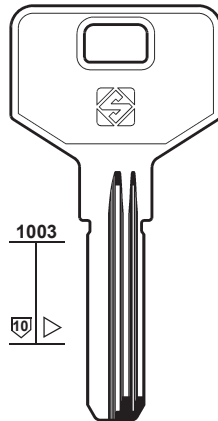

**EZ5X**  
DS15

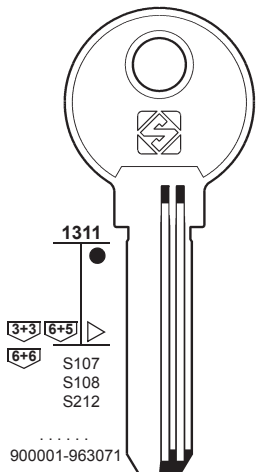

**FAC15**

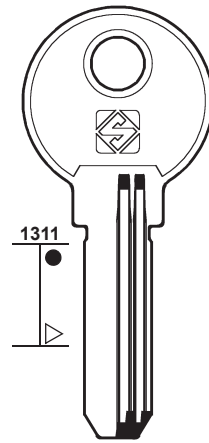

**FAC31**



# 234

PER / FOR

FAC (ES)

FAVOUR (DZ)

FAYN (TR)

FB (ES)

👁️ AGA (225)

FCV (DE)

KFV

VBH

FEB (IT)

👁️ VIRO (248)

F.F. (IT)

FIAM (IT)

+ 👁️ KESO (238)

FTH (FR)

CODEM  
GOTTA  
IFAM  
ITO  
KARO  
SP  
TOVER  
YALTRES

PER:  
FOR:

### FAC

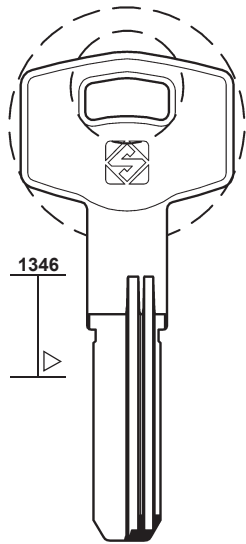

1346



FAC32

### FAVOUR

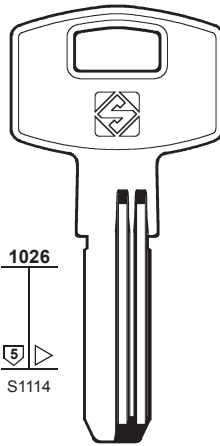

1026

5  
S1114



FVR1

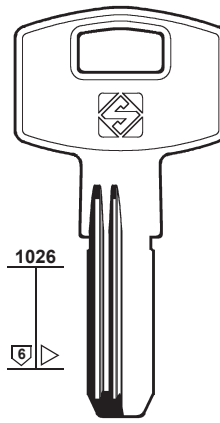

1026

6



FVR2R



FVR4R



FVR3

### FAYN

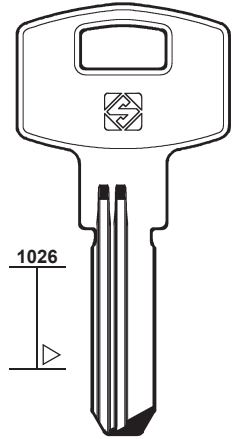

1026

6



FY1R

PER:  
FOR:

### FCV

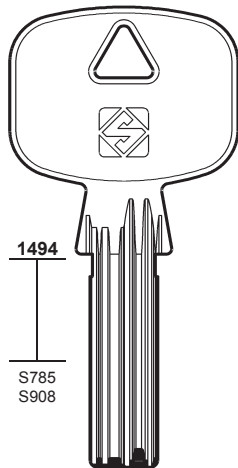

1494

4  
S785  
S908



FV4

KFV - VBH

### F.F.

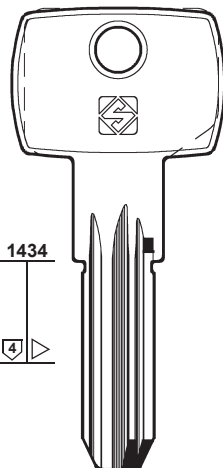

1434

4



FF19

### FIAM

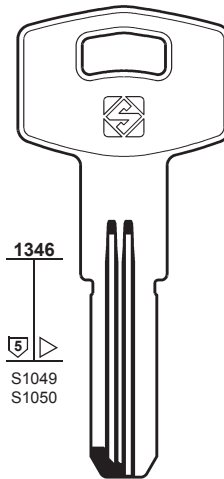

1346

5  
S1049  
S1050



FI3R

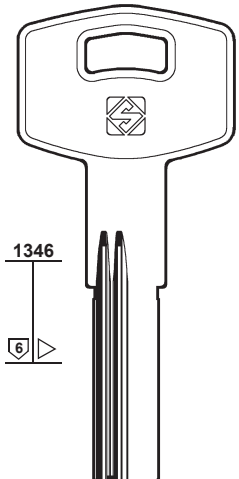

1346

6



FI4R

PER:  
FOR:

### FTH

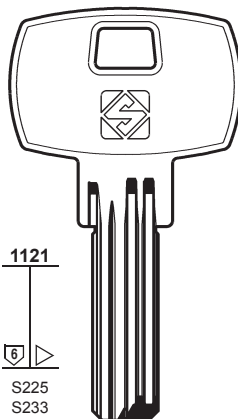

1121

6  
S225  
S233



FH12

CODEM - GOTTA - ITO  
TOVER - YALTRES

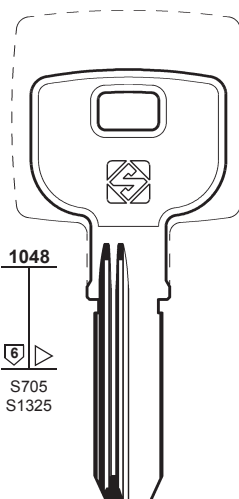

1048

6  
S705  
S1325



FH17R



FH37R

..... 1-2-3-4-5

IFAM  
KARO

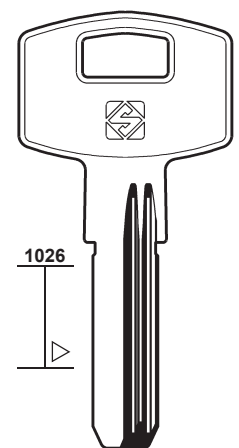

1026

6



FH32

SP

PER:  
FOR:

### FTH

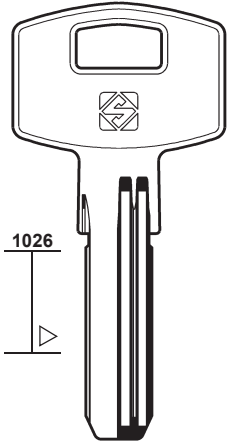

1026



FH33

SP

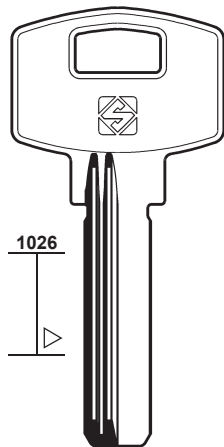

1026



FH34R

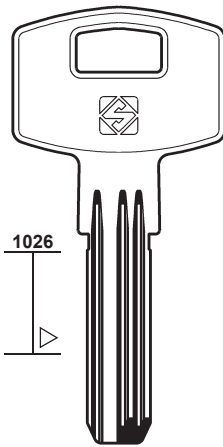

1026



FH35

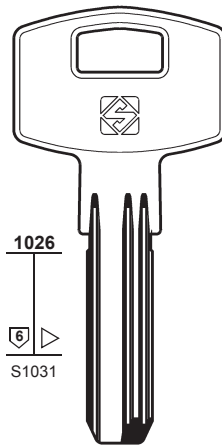

1026

6  
S1031



FH36

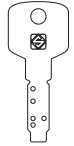

# 235

PER / FOR

FTH (FR)

SP

GATEMATE (GB)

GARRISON (GB)

MUL.T.LOCK (242)

GEGE (AT)

GERDA (PL)

MCM (240)

GEVY (GR)

BASSI

MOTTURA

STUV

+ DELCA (231)

GIUSSANI (IT)

GOAL (JP)

GOTTA (DE)

FTH (234)

GP (IT)

PER:  
FOR:

### GATEMATE

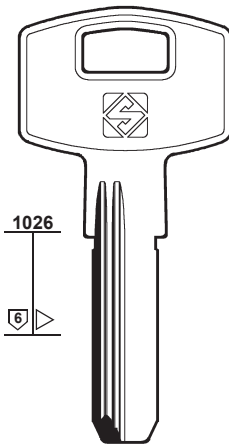

1026

6



GAT1R

### GEGE

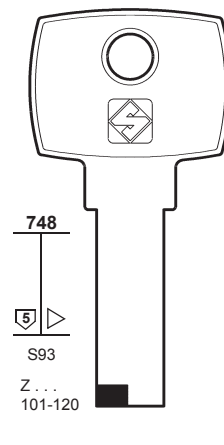

748

5

S93  
Z...  
101-120



GE57

### GEVY

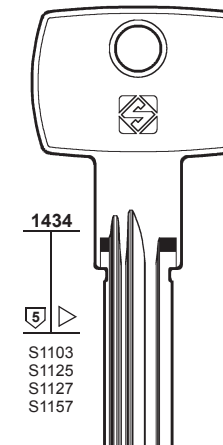

1434

5

S1103  
S1125  
S1127  
S1157



GVY1R

..... 600001-613040  
..... 900001-902780

BASSI - MOTTURA - STUV

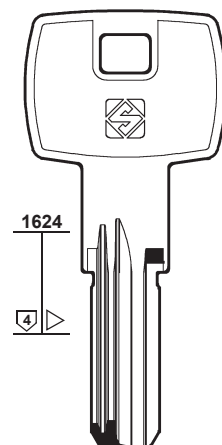

1624

4



GVY2R

BASSI

PER:  
FOR:

### GIUSSANI

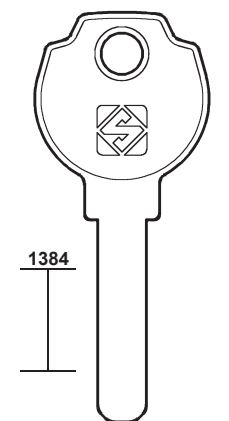

1384



GS17

### GOAL

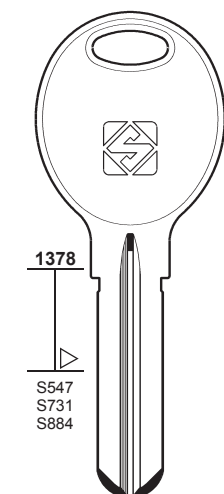

1378

S547  
S731  
S884



GO6

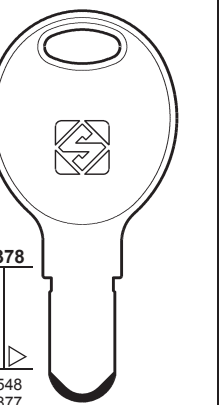

1378

3

S548  
S877



GO7

### GP

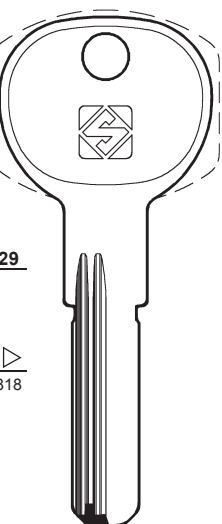

1129

7

S1818



GPI1



# 236

**PER / FOR****GRIFO** (TW)**HASLER** (DE)

👁️ SEA (244)

**HB** (IT)

👁️ LEGALLAIS (239)

**HOK** (TR)**HOOPLY** (TW)

👁️ CINA (229)

👁️ WANJIN (248)

**HTEC** (ES)**HUGO** (DE)

+ 👁️ BRISANT (228)

**IBFM** (IT)**ICSA** (IT)

👁️ LINCE (239)

**IFAM** (ES)

👁️ FTH (234)

**I.R.** (FR)

+ 👁️ DOM (231)

**ISEO** (IT)

CITY

VACHETTE

+ 👁️ UCEM (247)

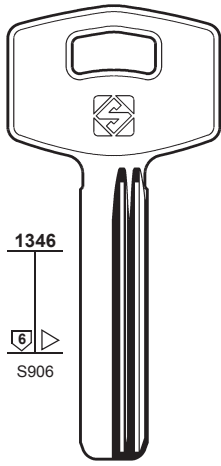
**PER: GRIFO****FOR:**

1346

6

S906

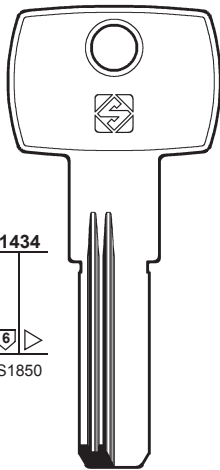
**GF1****PER: HOK****FOR:**

1434

6

S1850

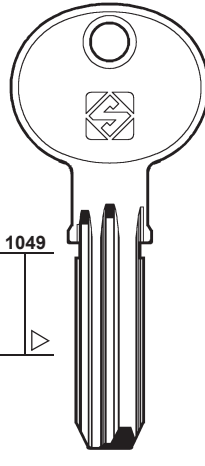
**HOK1R****HOK2R****PER: HTEC****FOR:**

1049

11

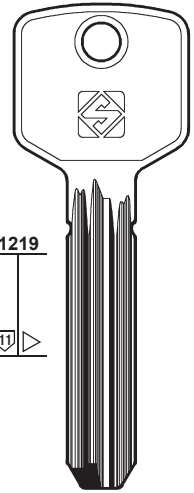
**HTE1****PER: HUGO****FOR:**

1219

11

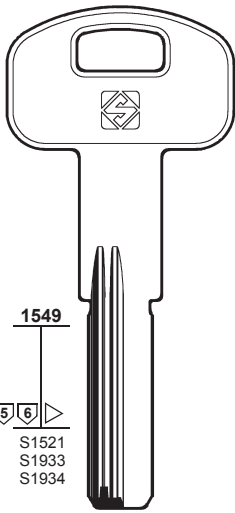
**HGO1R****PER: IBFM****FOR:**

1549

5

6

S1521

S1933

S1934

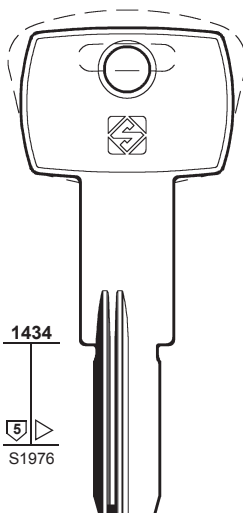
**IBF2R**

1434

5

S1976

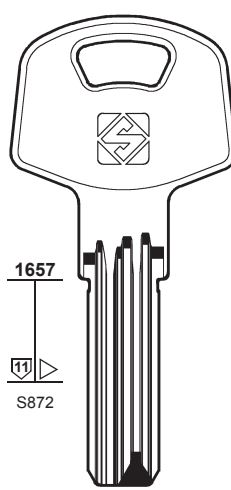
**IBF3R****PER: IFAM****FOR:**

1657

11

S872

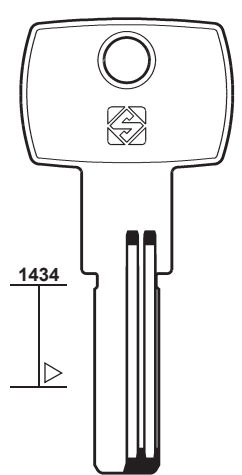
**IF14****PER: I.R.****FOR:**

1434

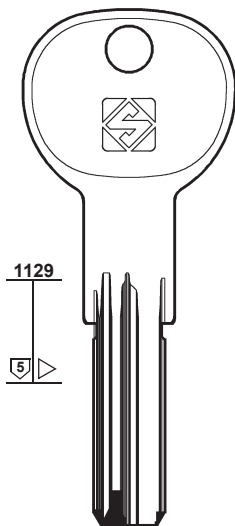
**IR1****PER: ISEO****FOR:****ISEO**

1129

5

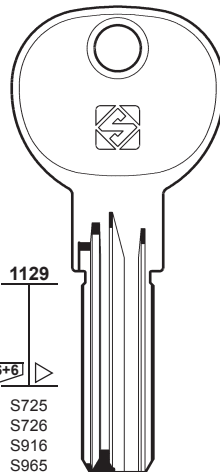
**IE30**

1129

5+6+6

S725

S726

S916

S965

EDL .....  
CFA ..... 1-27065  
EDL ..... 1-350589**IE14**

R11

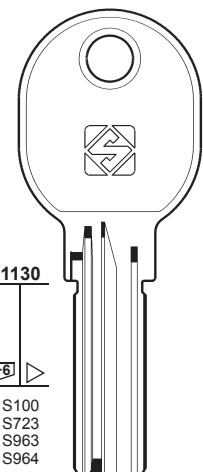

1130

5+6+6

S100

S723

S963

S964

ABL ..... 1-015328  
ACY ..... 1-015328  
AGL ..... 1-015328  
ABF ..... 1-015694**IE15**

R6

**CITY - VACHETTE**

PER:  
FOR:

### ISEO

### ITO

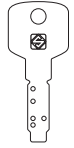

# 237

PER / FOR

**ISEO (IT)**  
ATRA  
CITY  
+ UCEM (247)

**ITO (TR)**  
+ FTH (234)

**JPM (FR)**  
+ KESO (238)

**KABA (CH)**  
BÖRKEY  
DORSET  
LÄSBOLAGET  
PICARD

**KAIXI (CN)**

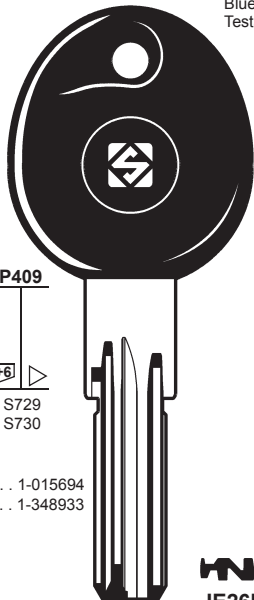
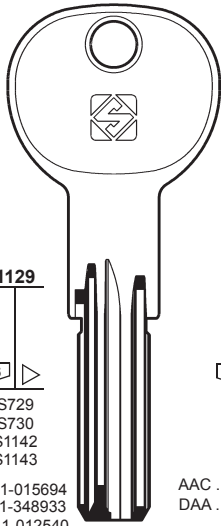

1129  
5+6+6  
S729  
S730  
S1142  
S1143

P409  
5+6+6  
S729  
S730

AAC ..... 1-015694  
DAA ..... 1-348933  
AMB ..... 1-012540  
AMB ..... 100001-112540

AAC ..... 1-015694  
DAA ..... 1-348933



IE26



IE26P

ATRA - CITY

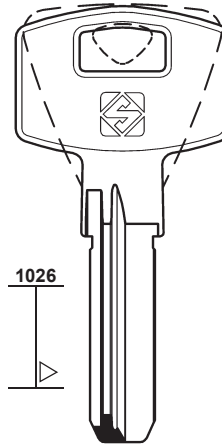
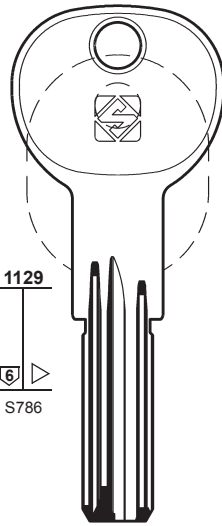

1129  
6  
S786

1026



IO1



IO2R

PER:  
FOR:

### KABA

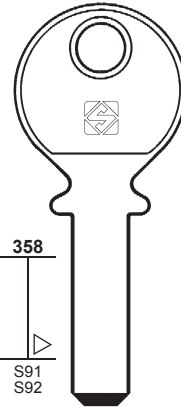
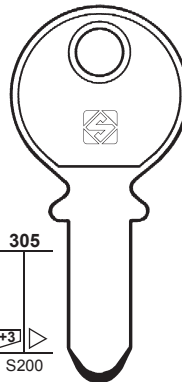
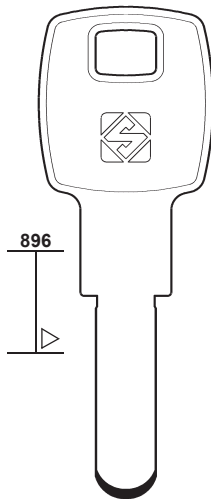
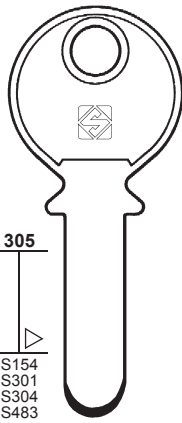
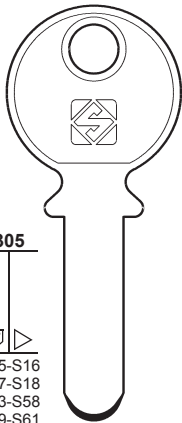

305  
17  
S15-S16  
S17-S18  
S53-S58  
S59-S61  
S114  
PH . . . .  
0001-9000  
. . . 1-200

305  
S154  
S301  
S304  
S483

896

305  
3+3+3  
S200

358  
S91  
S92

mm 2  
KA1  
8

mm 2,5  
KA2  
20

mm 2,5  
KA7

KA6

KA3  
MINI KABA

LÄSBOLAGET

PICARD

BÖRKEY

PER:  
FOR:

### KABA

### KAIXI

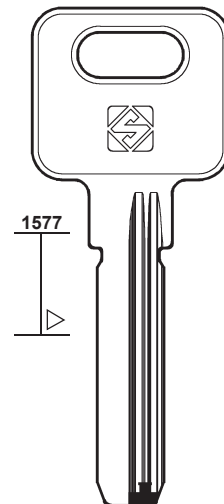
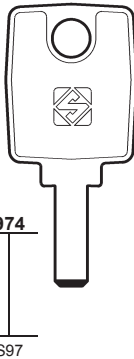
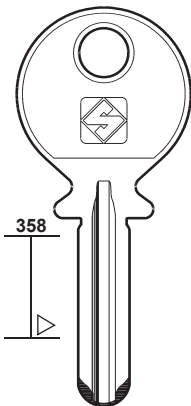
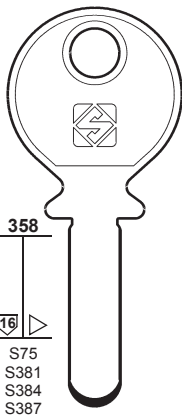
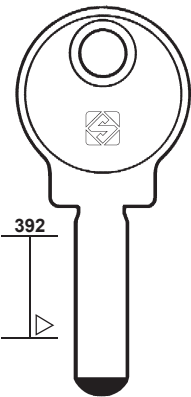

392

358  
16  
S75  
S381  
S384  
S387

358

974  
S97

1577

KA4

KA5

KA9

KA8  
MICRO KABA



KAX1



KAX1R

GEMINI  
DORSET





# 238

PER / FOR

**KAKEN** (KR)

**KALE** (TR)  
+ TESA (246)

**KARO** (ES)  
 FTH (234)

**KESO** (CH)  
ALA  
FIAM  
JPM  
LIPS  
SARGENT

PER: **KAKEN**

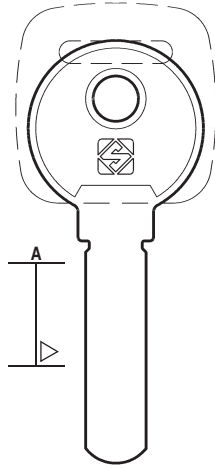

A

**KAK1**



PER: **KALE**

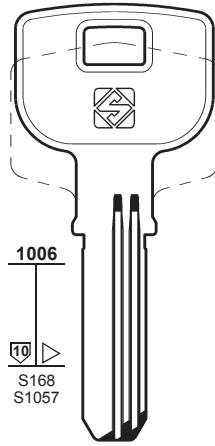

1006

S168  
S1057

**KLE1**

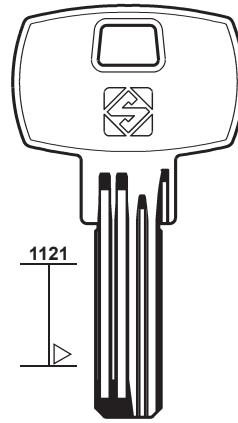

1121

**KLE2R**

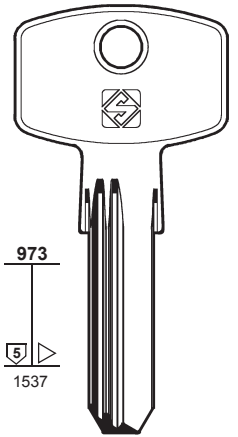

973

S1537

**KLE8R**



PER: **KALE**

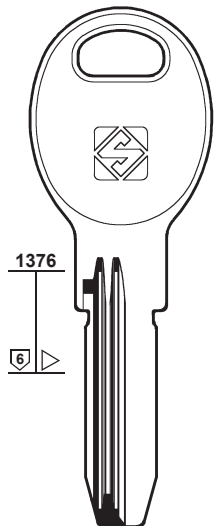

1376

S1643

**KLE9R**

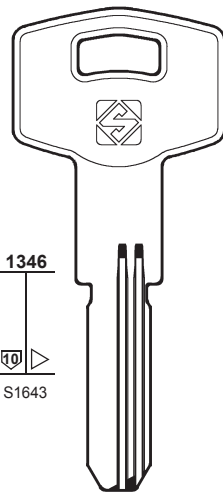

1346

S1643

**KLE10R**

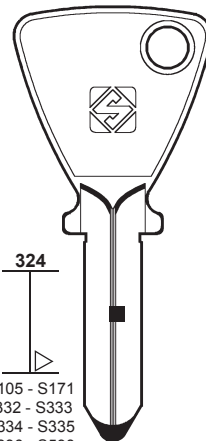

324

S105 - S171  
S332 - S333  
S334 - S335  
S336 - S598  
S599 - S600  
S601 - S678  
S807

**KE1**

JPM

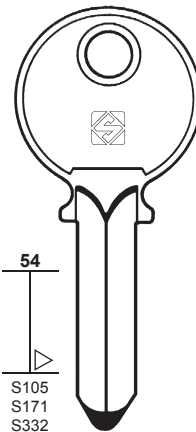

54

S105  
S171  
S332  
S333  
S334  
S335  
S336  
S598  
S599  
S600  
S601

**KE2**

JPM

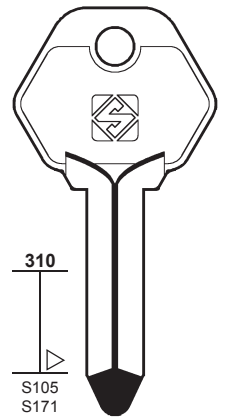

310

S105  
S171  
S332  
S333  
S334  
S335  
S336  
S598  
S599  
S600  
S601

**KE4**

SARGENT



PER: **KESO**

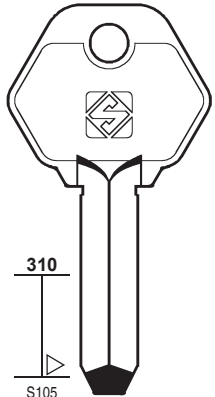

310

S105

**LP11**

LIPS

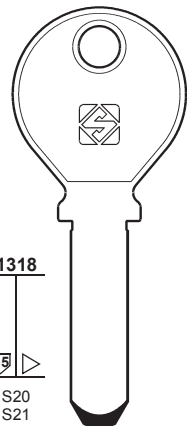

1318

S20  
S21  
S57  
S267  
S273  
S277  
S359  
S1298

**KE3**

ALA

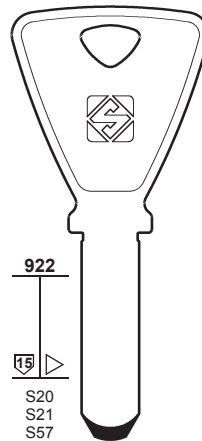

922

S20  
S21  
S57  
S267  
S273  
S277  
S359  
S663  
S1298

**KE9**

JPM

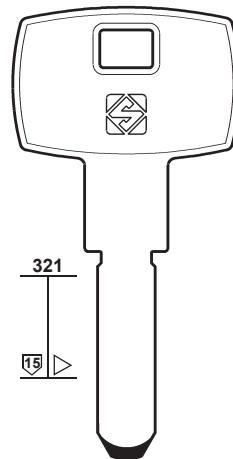

321

S2000

**KE11**

FIAM

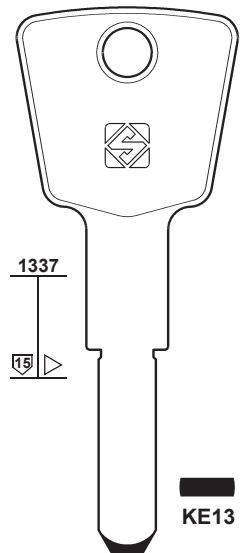

1337

S2000

**KE13**

FIAM





PER:  
FOR: **KESO**

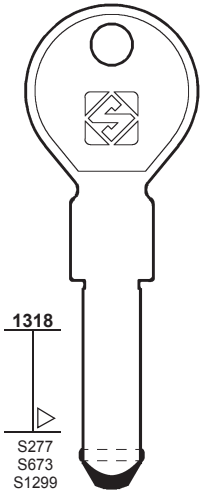

**KE19**

2000 S Omega  
2000 S (STEP-DRILLING)

**LAPERCHE**

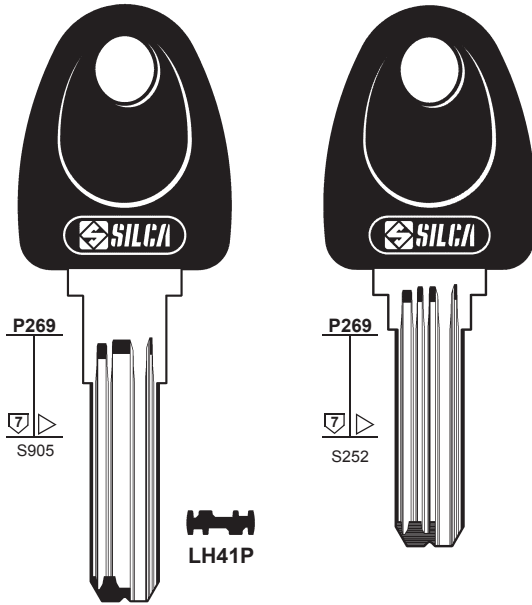

**LH41P**



DIAM



**239**

PER / FOR

**KESO** (CH)

**KFV** (DE)

👁️ **FCV** (234)

**KYR** (IT)

👁️ **SECURITAL** (244)

**IMSI** (IT)

👁️ **PERINO PG** (243)

**JPM** (FR)

👁️ **KESO** (238)

**LAPERCHE** (FR)

DIAM

+ 👁️ **DOM** (231)

**LÅSBOLAGET** (SE)

👁️ **KABA** (237)

**LEGALLAIS** (FR)

HB

**LINCE** (ES)

ICSA

**LIPS** (NL)

+ 👁️ **KESO** (238)

**LOB** (PL)

👁️ **MCM** (240)

**LOCKSYS** (BG)

PER:  
FOR: **LEGALLAIS**

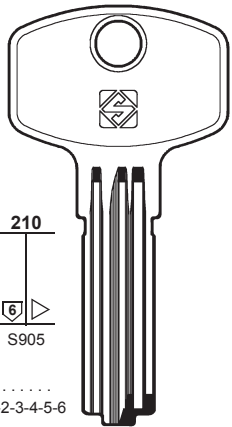

**LEA1**

HB

**LEHMANN**

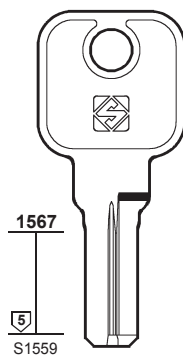

**MLM9**

MLM

**LINCE**

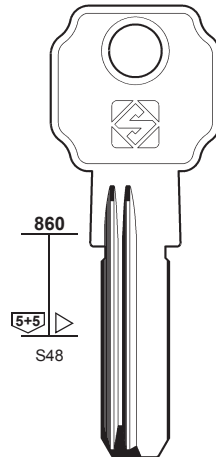

**LC14R**  
X

ICSA

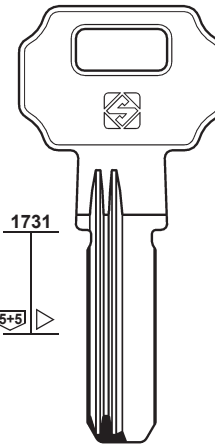

**LC26R**

PER:  
FOR: **LIPS**

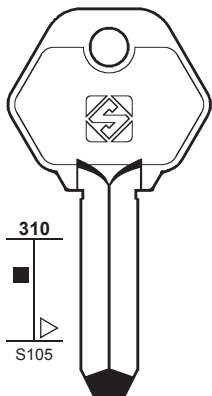

**LP11**

**LOCKSYS**

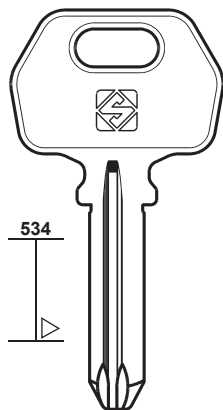

**LCK1R**

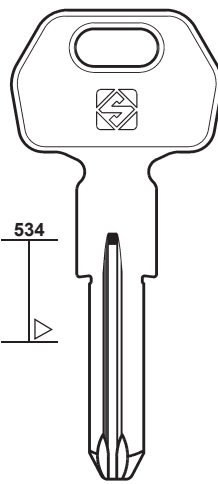

**LCK1RX**

**LOK 2000**

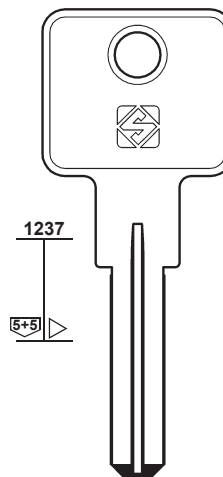

**LOK2**



mm 70



# 240

PER / FOR

**MAGNUM** (GB)

**MASTER** (US)

+ TOVER (246)

**MASTER LOCK** (CN)

+ CINA (229)

**MAUER LOCKS** (BG)

DEKABA (231)

**MCM** (ES)

GERDA  
LOB  
TROMER  
YETI

## PER: MAGNUM

FOR:

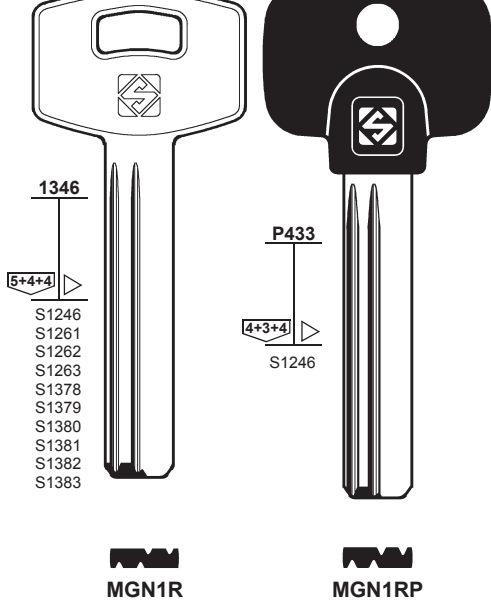

## PER: MASTER

FOR:

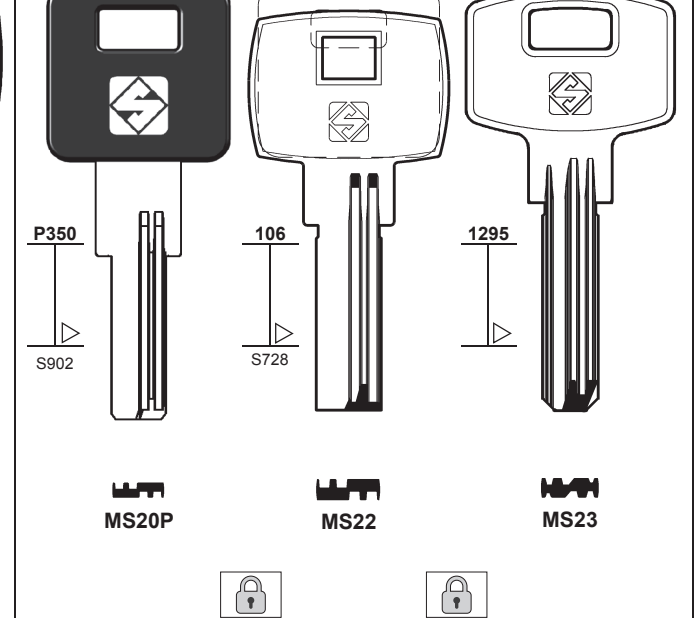

## PER: MASTER LOCK

FOR:

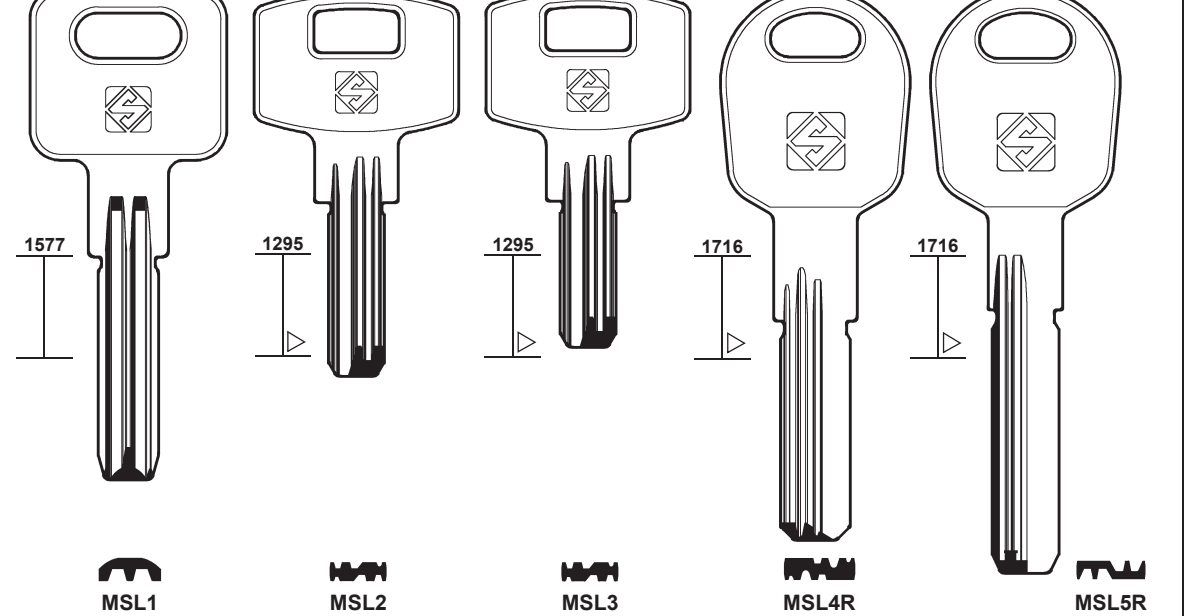

## PER: MCM

FOR:

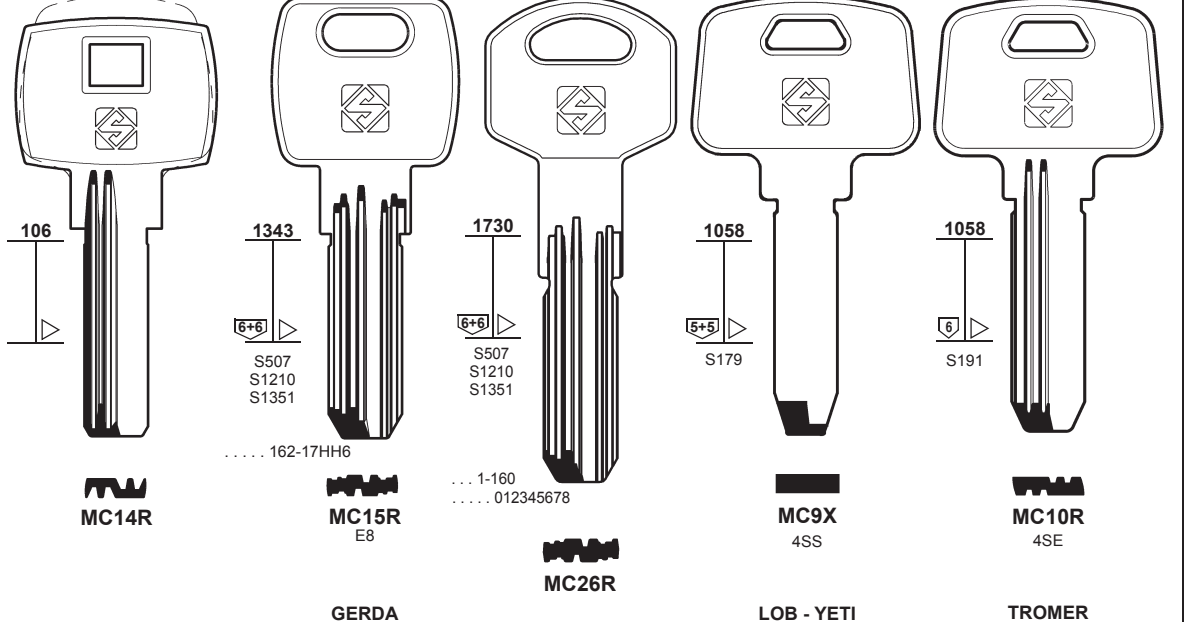

PER:  
FOR:

**MEGA**

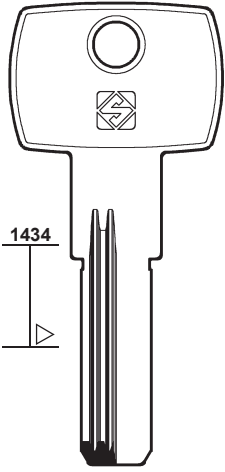

**MEG1R**

**MERONI**

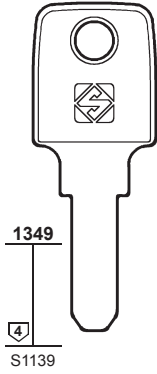

**MER39**  
WA.....

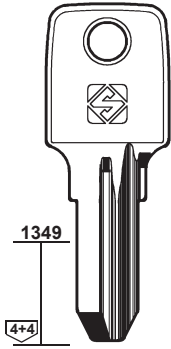

**MER38**

**METAL**

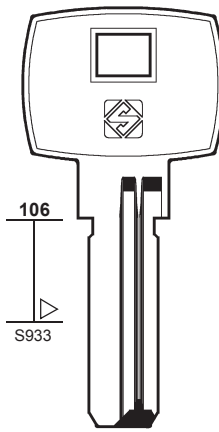

**MTA2**

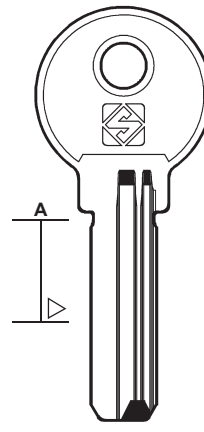

**MTA4**



**241**

PER / FOR

**MEGA (RO)**

**MERONI (IT)**

+ CAS-CISMA (228)

**METAL (BG)**

**MG (MONTI) (IT)**

**MLM (FR)**

**MODA (FR)**

+ PICARDIE (243)

**MOREAUX (FR)**

+ DOM (232)

**MOTTURA (IT)**

+ GEVY (235)

+ CAS-CISMA (228)

**MSM (CN)**

+ CINA (229)

**MULT-LEI (GR)**

**MULT.LOCK (IL)**

PER:  
FOR:

**MG (MONTI)**

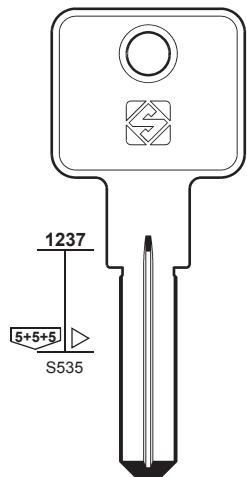

S535



**MG8**  
PBA

.....  
001001-163000

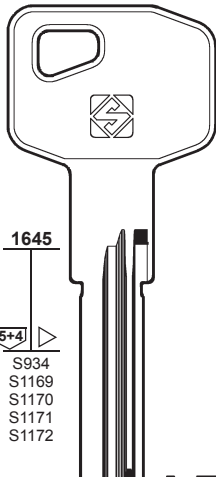

S934  
S1169  
S1170  
S1171  
S1172



**MG9**  
X8

A5 ..... 00010-28000  
A6 ..... 00010-28000  
A7 ..... 00010-28000  
A8 ..... 00010-28000

**MLM**

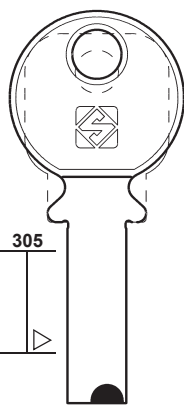

**MLM5**

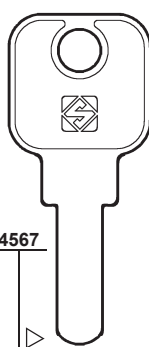

**MLM15**

**MOIA**

Orange head  
Testa arancione

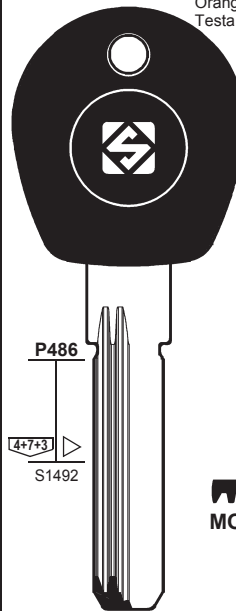

S1492



**MO1RP**

PER:  
FOR:

**MULT-LEI**

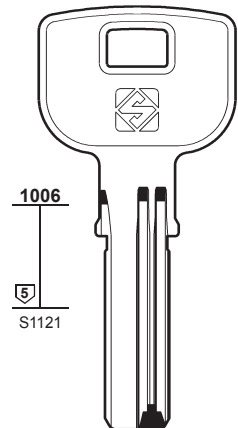

S1121



**MTL1**

**MULT.LOCK**

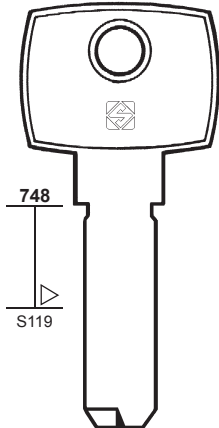

S119



**MTK1**

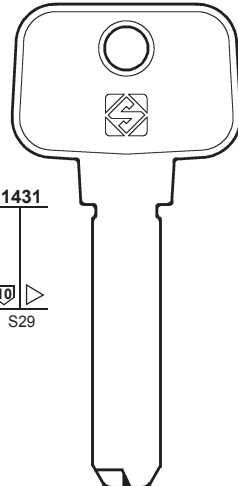

S29

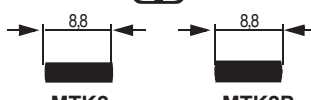

**MTK2**  
(006)  
ABCD-12345

**MTK2P**  
(006)  
ABCD-12345

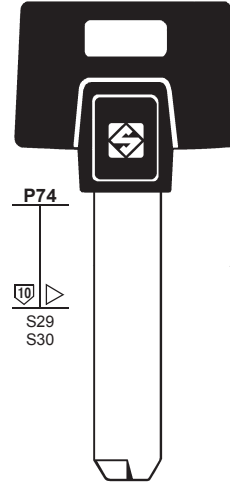

S29  
S30



**MTK3P**  
(006)  
ABCD-12345-01



242

PER / FOR

MUL.T.LOCK (IL)  
GARRISON  
SP

OJMAR (ES)

OMEC (IT)  
SANTOS

PER:  
FOR:

### MUL.T.LOCK

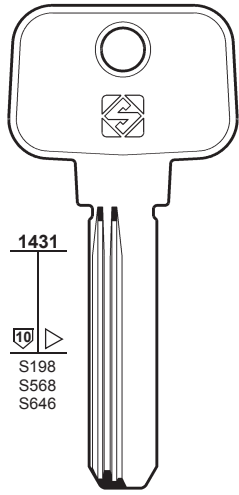

1431



S198  
S568  
S646

06 MTK11R

05 MTK11  
(005)  
ABCD-12345

MTK10R  
(006)  
ABCD-12345-01

64 MTK8R  
(006)  
ABCD-12345-01

50 MTK7R  
(006)  
ABCD-12345-01

GARRISON

11 MTK16

66 MTK15R

77 MTK13R

08 MTK12R  
(008)  
ABCD-12345

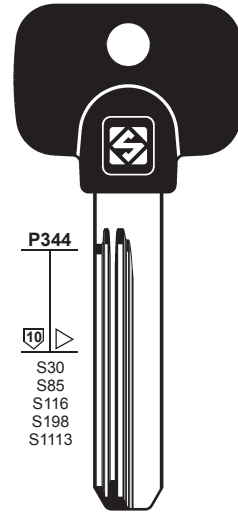

P344



S30  
S85  
S116  
S198  
S1113

MTK10RP  
(006)  
ABCD-12345-01

MTK9RP

64 MTK8RP  
(006)  
ABCD-12345-01

50 MTK7RP  
(006)  
ABCD-12345-01

05 MTK4P  
(005)  
ABCD-12345

06 MTK4RP  
(006)  
ABCD-12345-01

SP

PER:  
FOR:

### MUL.T.LOCK

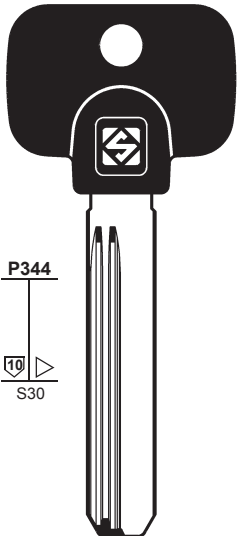

P344



S30

06 MTK4RPX

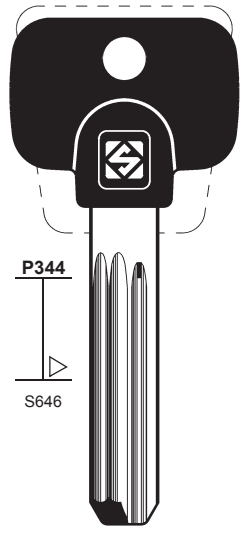

P344



S646

08 MTK12RP  
(008)  
ABCD-12345

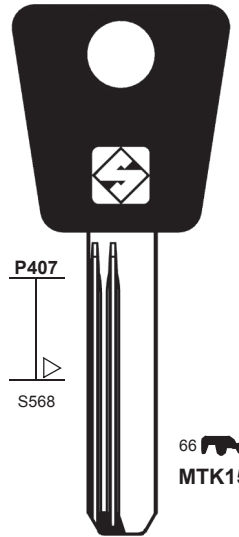

P407



S568

66 MTK15RAP

77 MTK13RAP

GARRISON

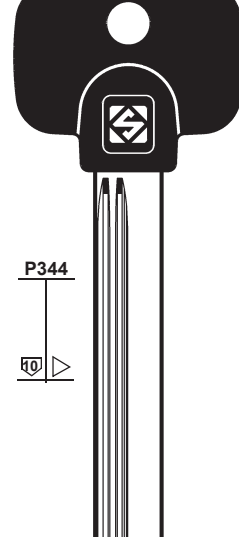

P344



MTK14RP

PER:  
FOR:

### OJMAR

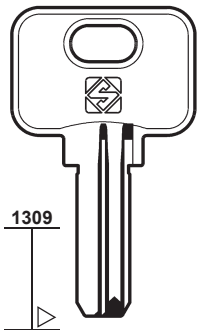

1309



OJ14

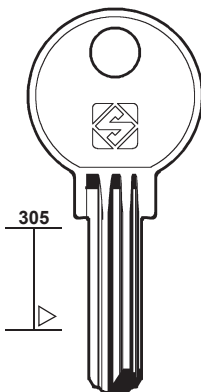

305



OJ18  
5-Q4

PER:  
FOR:

### OMEC

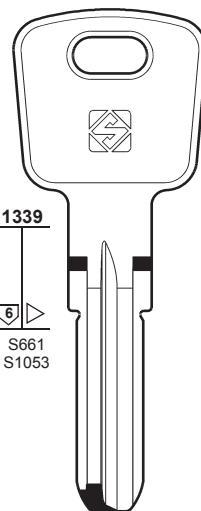

1339



S661  
S1053

OC3

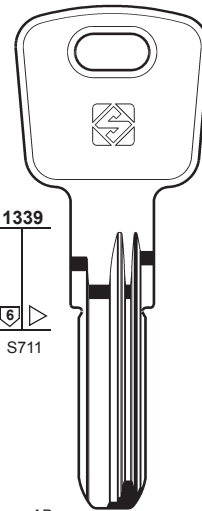

1339



S711

AB .....  
0000001-0046656

OC4

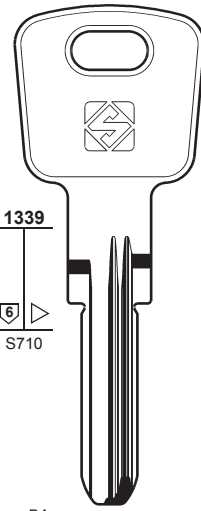

1339



S710

BA .....  
0000001-0046656

OC6

SANTOS

PER: **PENZA**      PERINO PG      PICARDIE

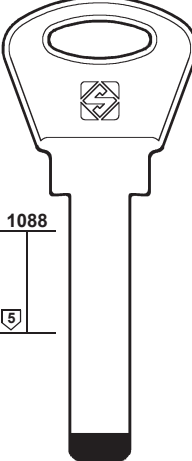
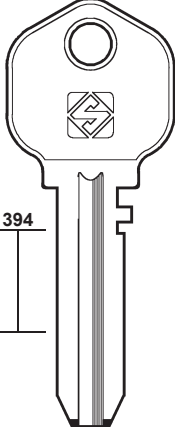
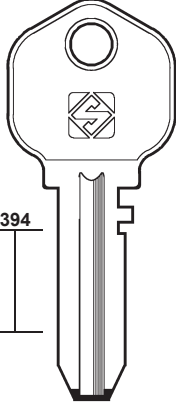
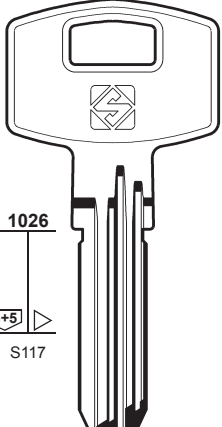
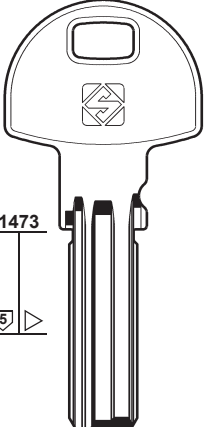
 <p>1088</p> <p>5</p> <p><b>BZ3</b></p>	 <p>394</p> <p><b>PN1</b></p>	 <p>394</p> <p><b>PN2</b></p>	 <p>1026</p> <p>6+5</p> <p>S117</p> <p><b>PIC1</b></p>	 <p>1473</p> <p>5</p> <p><b>PIC2</b></p>
	IMSI		DECAYEUX - MODA S & E - STS	



**243**

PER / FOR

**PENZA (RU)**

**PERINO PG (IT)**  
IMSI

**PICARDIE (FR)**  
DECAYEUX  
MODA  
S & E  
STS

**PICARD (FR)**  
KABA (237)



**POTENT (IT)**

**PREFER (IT)**

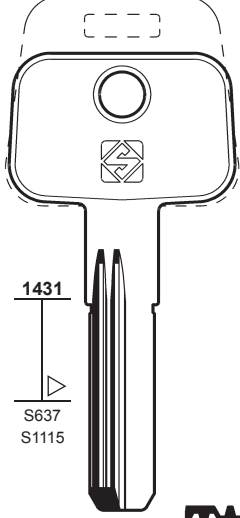
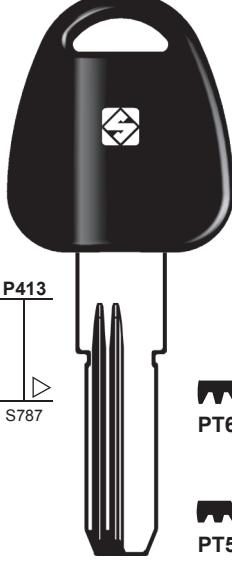
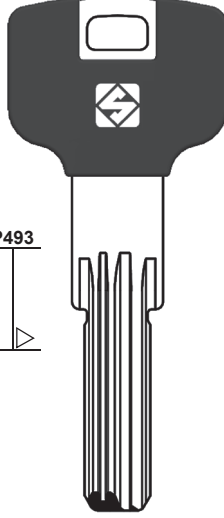
PER: **POTENT**

 <p>1431</p> <p>S637 S1115</p> <p><b>PT4R</b> ..... 1-2-3-4-5</p>	 <p>P413</p> <p>S787</p> <p><b>PT6RP</b></p>	 <p>P493</p> <p><b>PT7RAP</b></p>
	<p><b>PT5RP</b> P04 ..... 1-2-3-4-5-6</p>	

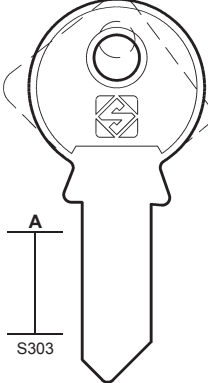
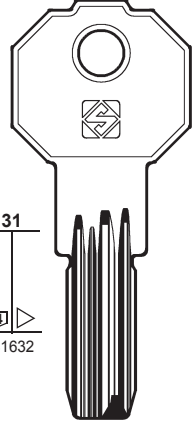
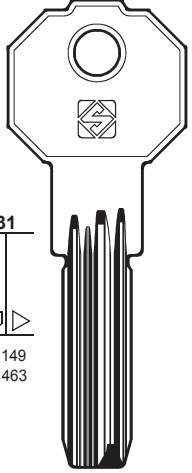
PER: **PREFER**

 <p>A</p> <p>S303</p> <p><b>PF18</b></p>	 <p>31</p> <p>4+4</p> <p>S1632</p> <p><b>PF22</b></p>	 <p>31</p> <p>5</p> <p>S1149 S1463</p> <p><b>PF20</b></p>	 <p><b>PF21</b></p>
---	--	---	--



# 244

PER / FOR

**ROSSETTI** (RO)

**S-TECH** (GB)

**S & E** (FR)

**PICARDIE** (243)

**SANTOS** (PT)

**OMEC** (242)

**SARGENT** (US)

**KESO** (238)

**SATURN** (SI)

**BASI**

**SEA** (CH)

**EZCURRA**  
**HASLER**  
**VIDMAR**

**SECUREMME** (IT)

**SECURIT** (IT)

**SECURITAL** (IT)

**KYR**

**SERRALLER** (ES)

**AGA** (225)

**SOBINCO** (BE)

**CAS-CISMA** (228)

**SP** (FR)

**FTH** (234-235)

**MUL.T.LOCK** (242)

PER: **ROSSETTI**

FOR:

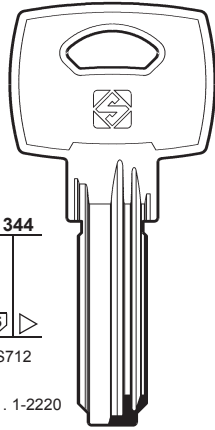

... 1-2220



**RSS3**

PER: **S-TECH**

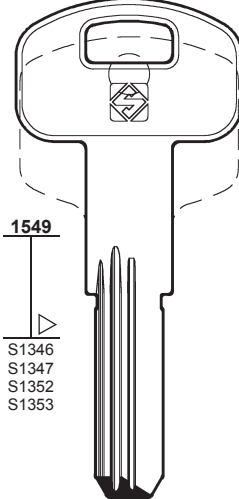

S1346  
S1347  
S1352  
S1353



**SCH1R**

PER: **SARGENT**

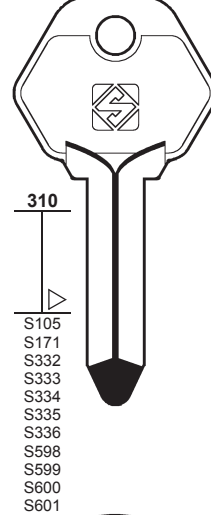

310  
S105  
S171  
S332  
S333  
S334  
S335  
S336  
S598  
S599  
S600  
S601



**KE4**

**KESO**

PER: **SATURN**

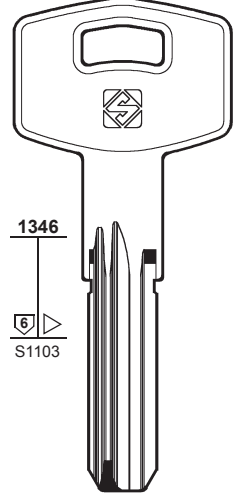

1346  
S1103



**STU6R**

**BASI**

PER: **SEA**

FOR:

**SEA**

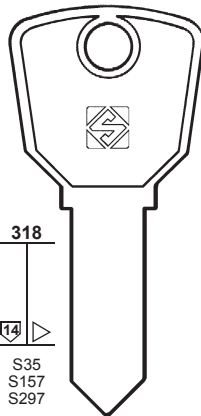

318  
S35  
S157  
S297



**SEB1**  
20-23

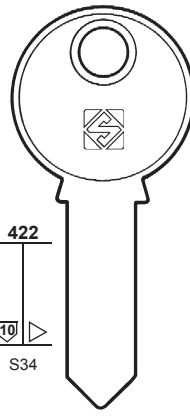

422  
S34



**SEB2**

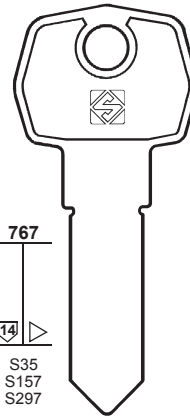

767  
S35  
S157  
S297



**SEB3**  
20-23

**EZCURRA - HASLER**

**EZCURRA - HASLER - VIDMAR**

PER: **SECUREMME**

FOR:

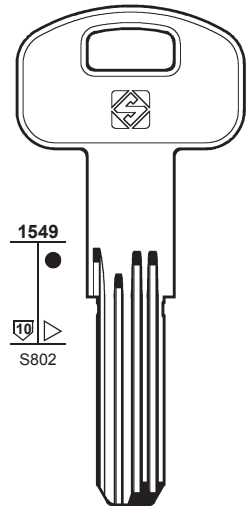

1549  
S802



**SCM1R**  
K2

PER: **SECUREMME**

FOR:

**SECUREMME**

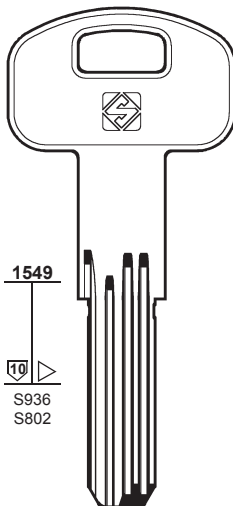

1549  
S936  
S802



**SCM2**  
K1

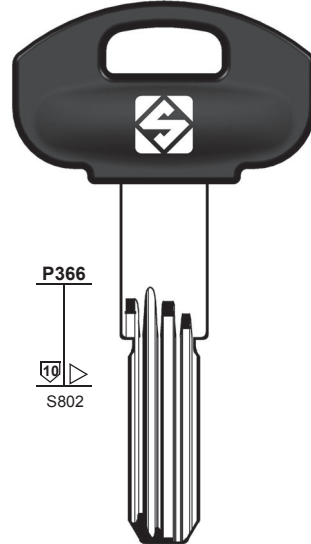

P366  
S802



**SCM3RP**

PER: **SECURIT**

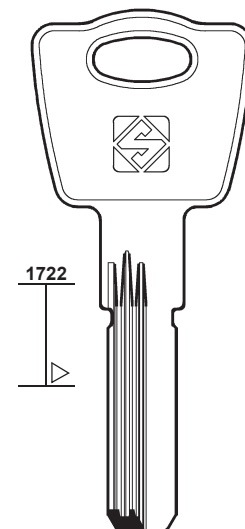

1722



**SCT1R**

PER: **SECURITAL**

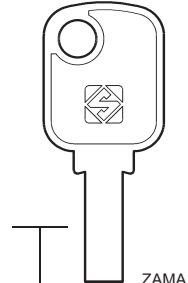

4  
S39  
S612  
S760  
S761  
S1265  
S1391

**SCU1**

**KYR**

PER:  
FOR:

### SPIDER

### STS



# 245

PER / FOR

**SPIDER (IL)**  
CAVERS  
CODKEY

**STS (ES)**  
TESA  
+ DOM (232)  
+ ELCA (232)  
+ PICARDIE (243)  
+ TESA (246)

**STUV (DE)**  
 GEVY (235)

**SÜDMETALL (DE)**

**TARONI (IT)**

**TECON (ES)**

**TECSESA (ES)**

**TEGASI (GR)**

**TERCA (ES)**  
 AGA (225)

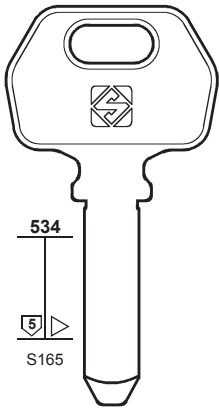

534

5

S165

**SPR1**

CODKEY

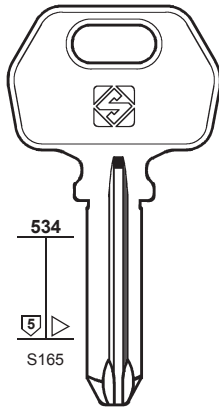

534

5

S165

**SPR2**

CAVERS

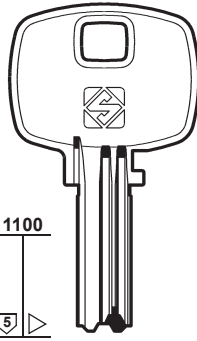

1100

5

S199

S1104

**STS5**

K . . . . 5001-8030

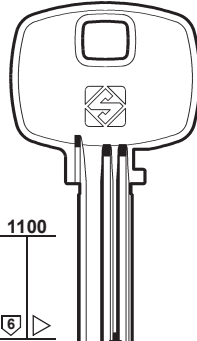

1100

6

S38

S62

S199

S436

S1104

**STS6**

P . . . . 5001-8030

J

K

K . . . . 5001-8030

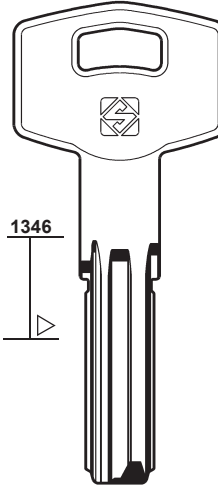

1346

**STS9**

PER:  
FOR:

### STS

### SÜDMETALL

### TARONI

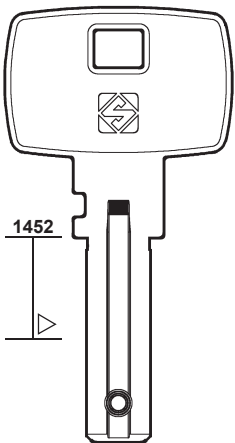

1452

**STS12**

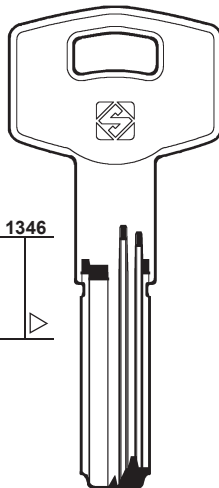

1346

**STS13**

TESA

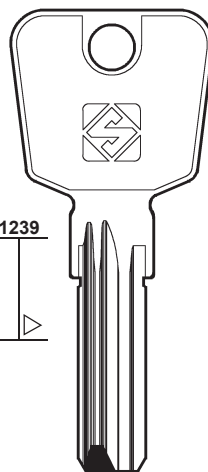

1239

**SDT1R**

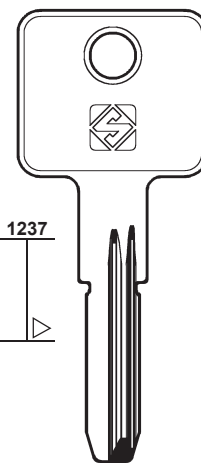

1237

**TAR21**

PER:  
FOR:

### TARONI

### TECON

### TECSESA

### TEGASI

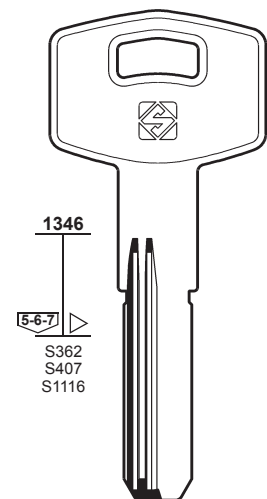

1346

5-6-7

S362

S407

S1116

**TAR16**

**TAR16R**

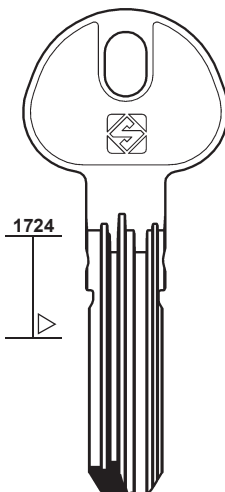

1724

**TEN1**

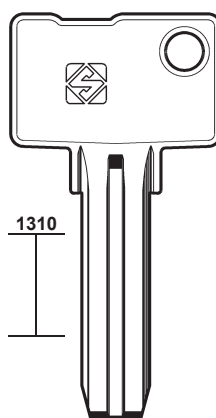

1310

**TEC1**

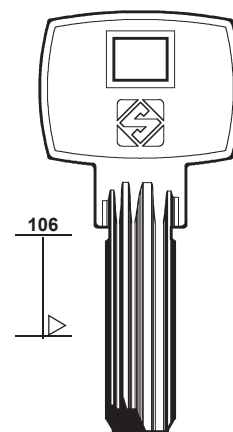

106

**TGS1R**



246

PER / FOR

TESA (ES)  
KALE  
STS  
VIRO  
+ ELCA (232)  
+ STS (245)

THIRARD (FR)

TILANCO (FR)

TITAN (SI)

TOVER (ES)  
MASTER  
TROMER  
+ FTH (234)

PER:  
FOR:

TESA

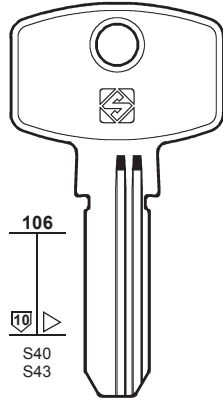

106

10

S40  
S43



TE4

T-10



TE4R

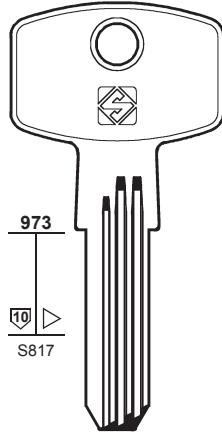

973

10

S817



TE16

T-10P

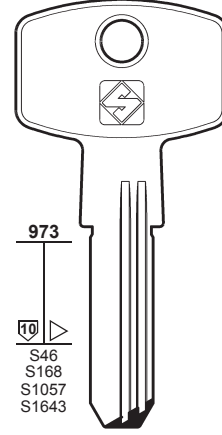

973

10

S46  
S168  
S1057  
S1643



EC5

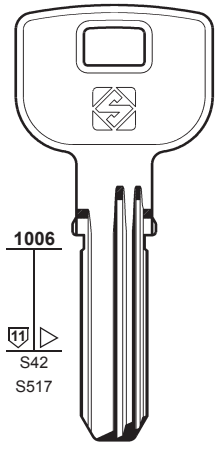

1006

11

S42  
S517



TE5

T-80



TE9

T80/SC

STS

KALE - STS - VIRO

STS

PER:  
FOR:

TESA

THIRARD

TILANCO

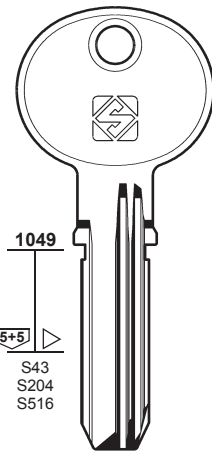

1049

5+5

S43  
S204  
S516



TE7

T-60

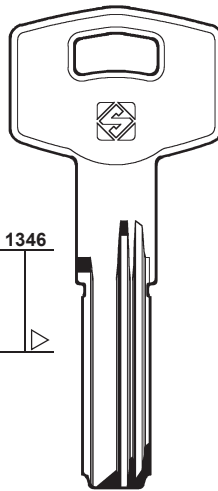

1346



TE19

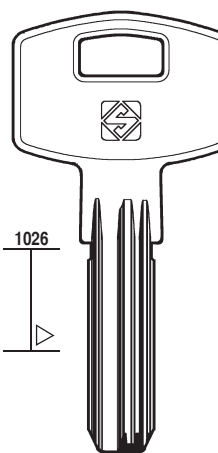

1026



THR1

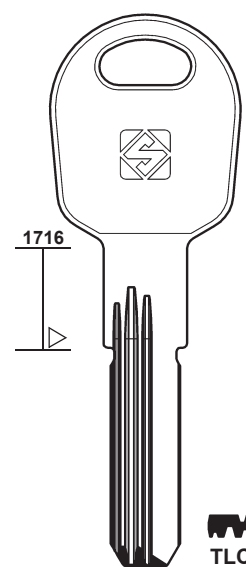

1716



TLC1R

STS

PER:  
FOR:

TITAN

TOVER

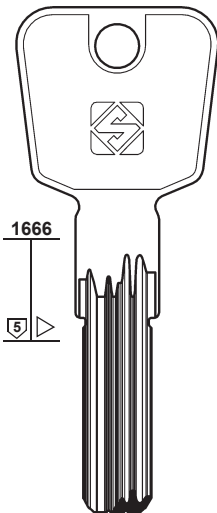

1666

5



TN51



TN32

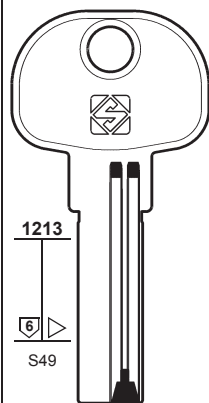

1213

6

S49



TV1

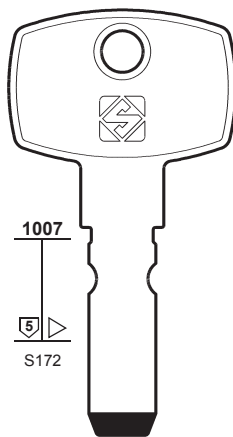

1007

5

S172



TV2

2F-35

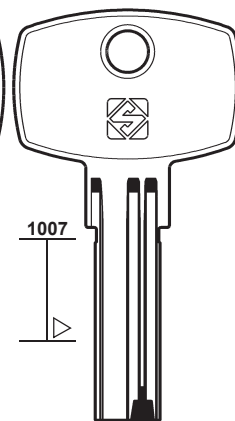

1007

5



TV3

2F-25

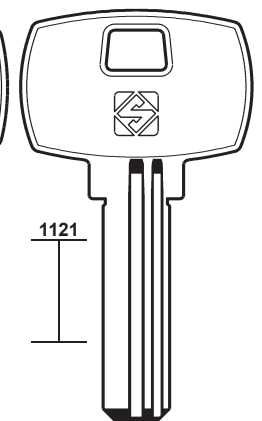

1121



TV4

MASTER

TROMER



PER:  
FOR: **TRIMARK**

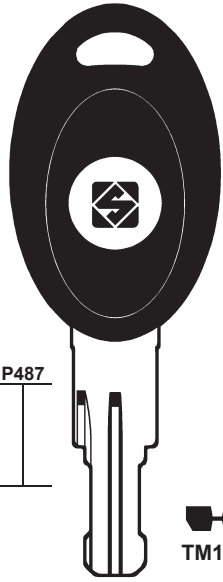

**TM1RP**

**UCEM**

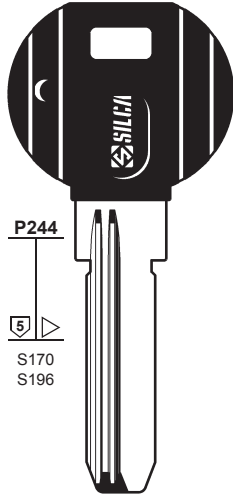

**UC3RP  
2000S**

ESAFE - ISEO  
YEMAR

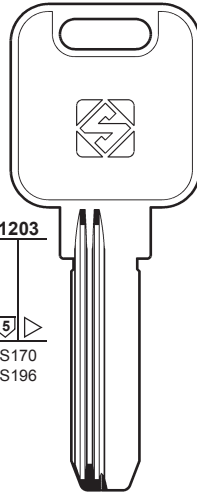

**UC5R**

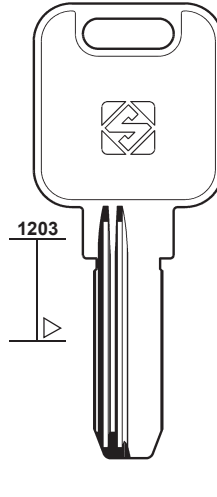

**UC4R**



**247**

PER / FOR

**TRIMARK (US)**

**TROMER (ES)**  
MCM (240)  
TOVER (246)

**UCEM (ES)**  
ESAFE  
ISEO  
YEMAR

**URBIS (RO)**  
BSS  
YALE

**VACHETTE (FR)**  
+ ISEO (236)

**VANGUARD (AR)**

PER:  
FOR: **UCEM**

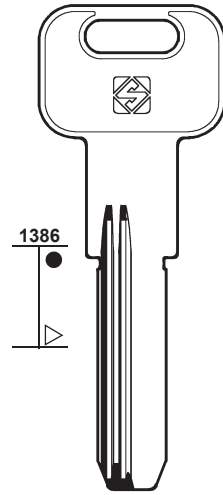

**UC8R**

**URBIS**

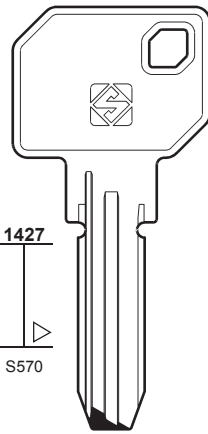

**UB3**

BSS - YALE

**VACHETTE**

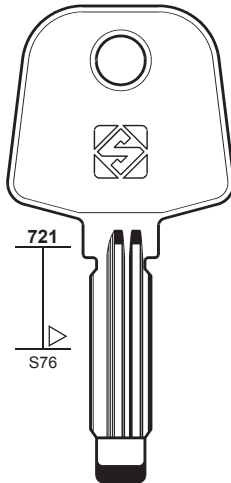

**VAC91**

RADIAL

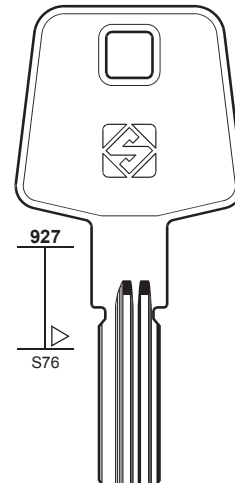

**VAC103  
VAC104  
VAC105**

RADIAL

PER:  
FOR: **VACHETTE**

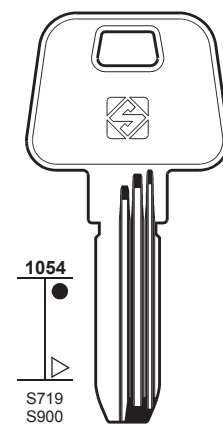

**VAC150  
V6**

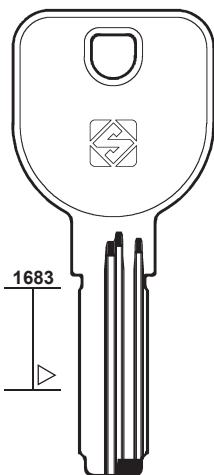

**VAC152**

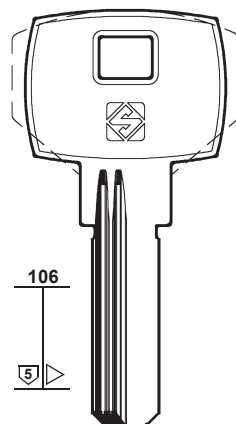

**VAC153R**

**VANGUARD**

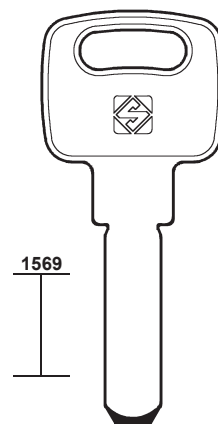

**VGD1**



# 248

**PER / FOR**

**VBH** (DE)  
+ **FCV** (234)

**VIDMAR** (CH)  
+ **SEA** (244)

**VIRO** (IT)  
**FEB**  
+ **ELCA** (232)  
+ **TESA** (246)

**WALLY** (IT)

**WANJIN** (CN)  
**HOOPLY**

**WAUS** (PL)

**WILKA** (DE)

**YALE** (GB) (IT)  
+ **URBIS** (247)

**YALTRES** (AR)  
+ **FTH** (234)

**YARDENI** (IL)

PER: FOR:	VBH	VIRO	WALLY	WANJIN
	 1590 	 1434 6 S630 	 1434 	 1603 7 
	<b>VBH1R</b>	<b>VI19</b> EURO-PRO <b>FEB</b>	<b>WA8</b>	<b>WJ1R</b> <b>HOOPLY</b>

PER: FOR:	WAUS	WILKA	YALE	
	 1006 S753 	 857 6+6 S621 	 1584 6 S1345 	 1584 10 S1346 
	<b>WU1R</b>	<b>WK70</b> ..... 10001-43000	<b>YA94</b> "1000 Series"	<b>YA95R</b> "2000 Series"

PER: FOR:	YALE		YARDENI	
	 1584 6 	 1584 6 S1071 	 748 	 1007 5+5 S78 
	<b>YA99R</b>	<b>YA90</b>	<b>YD3R</b>	<b>YD6R</b>

PER:  
FOR:

### YARDENI

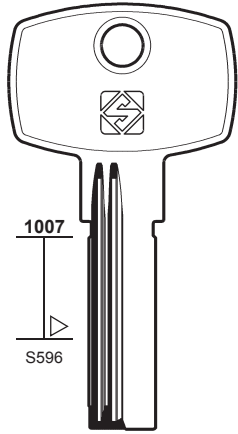

**YD7R**

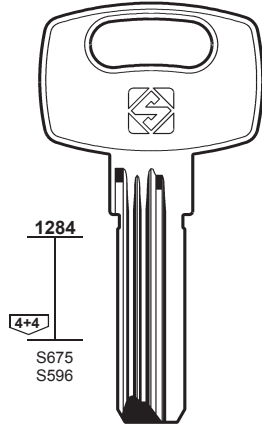

**YD13R**  
XL  
**YD14R**  
6

### ZADI

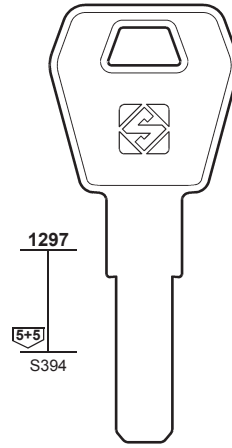

**ZD25**  
BULLOCK



# 249

PER / FOR

**YARDENI** (IL)

**YEMAR** (ES)  
UCEM (247)

**YETI** (PL)  
MCM (240)

**ZADI** (IT)  
BULLOCK

**ZHONGHENG** (CN)

PER:  
FOR:

### ZHONGHENG

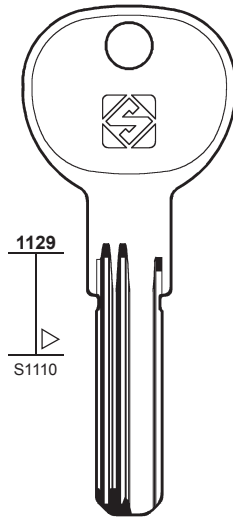

**ZH1R**

PER:  
FOR:





Cruciform keys  
Chiavi a croce  
Kreuzschlüssel  
Clés cruciformes  
Llaves en cruz  
Chaves tetra



PER:  
FOR: **A.G.C.**

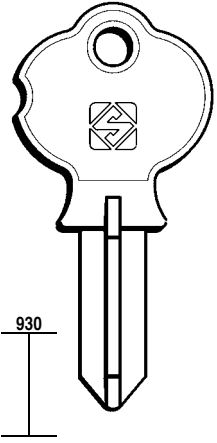

**ALA**

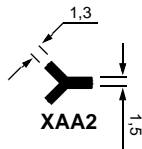
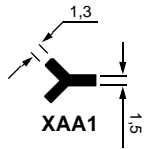
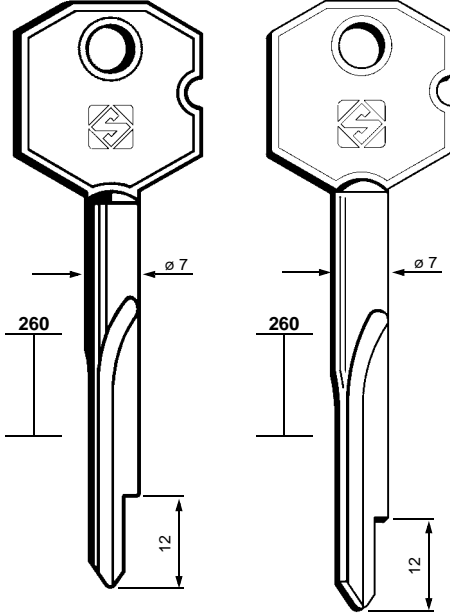

**BLUMA**

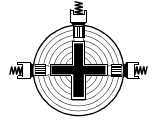
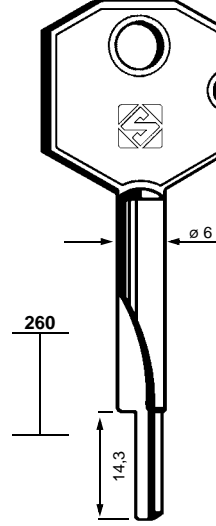

**253**

PER / FOR

**A.G.C.** (PT)

**ALA** (IT)

**BKS** (DE)

**YALE** (263)

**BLUMA** (DE)

**BRASIL** (BR)

**BRYANSK** (RU)

PER:  
FOR: **BLUMA**

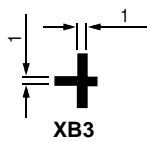
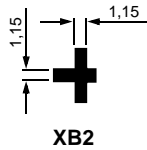
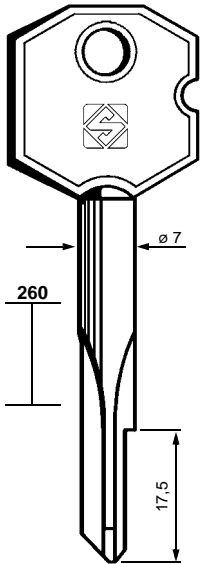

**BRASIL**

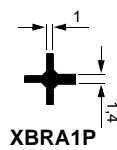
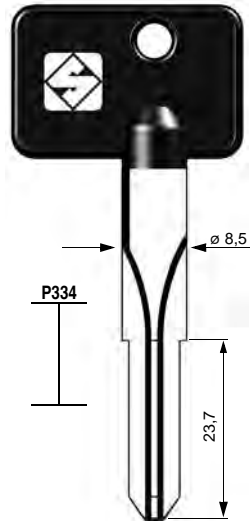

**BRYANSK**

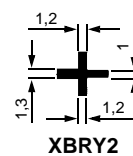
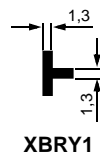
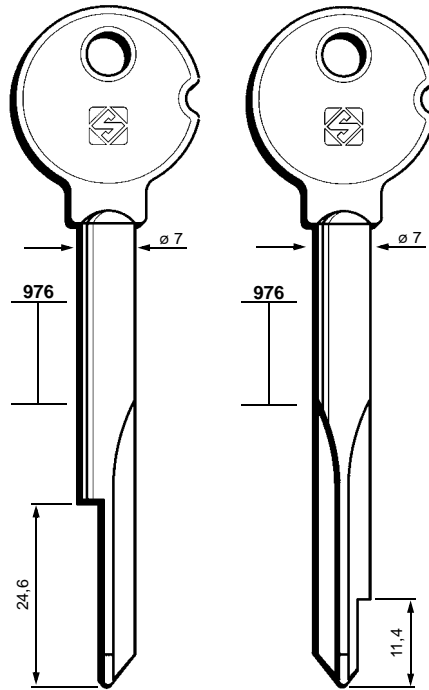

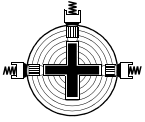

254

PER / FOR

BURG WÄCHTER (DE)  
FIAM PRÄZIS  
TRIOVING

PER:  
FOR:

### BURG WÄCHTER - Fiam Präzis

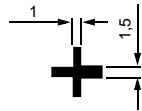
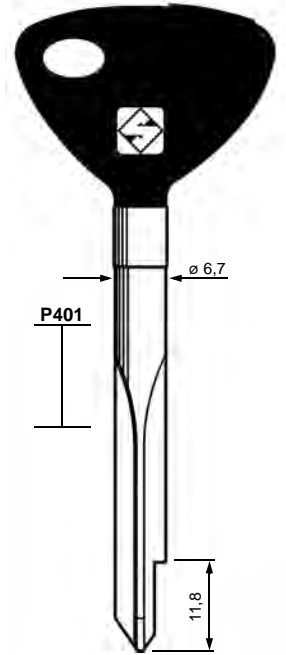
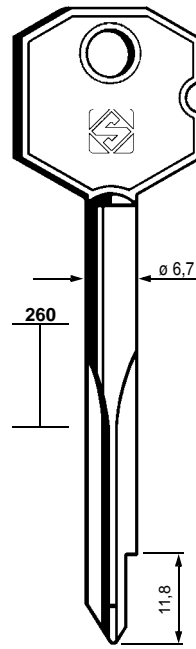
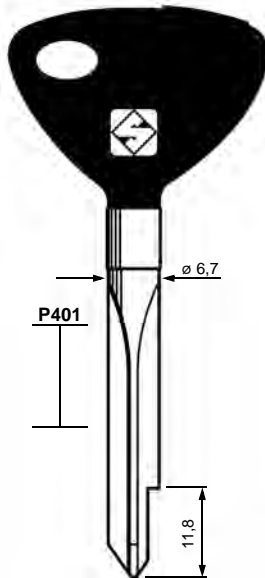
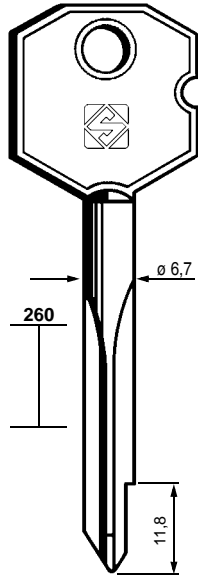

**XBW1**  
mm 75

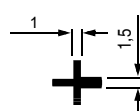

**XBW1P**  
mm 75

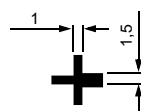

**XBW2**  
mm 85

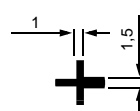

**XBW2P**  
mm 85

TRIOVING

PER:  
FOR:

### BURG WÄCHTER - Fiam Präzis

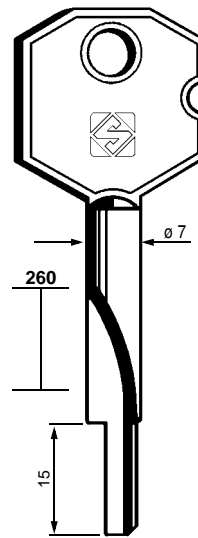
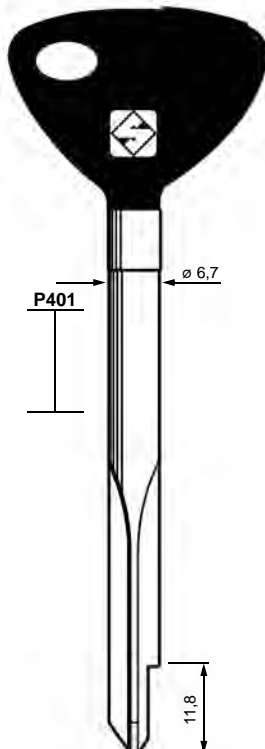
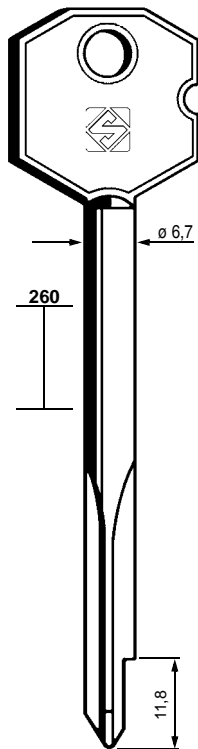

**XBW4**

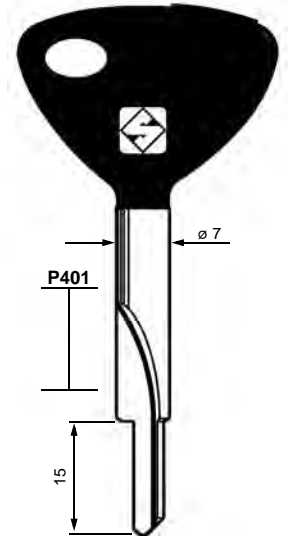

**XBW4P**

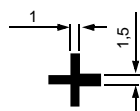

**XBW3**  
mm 100

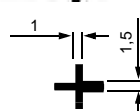

**XBW3P**  
mm 100



PER:  
FOR:

# BURG WÄCHTER - Fiam Präzis

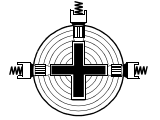

# 255

PER / FOR

**BURG WÄCHTER** (DE)  
FIAM PRÄZIS

**BRICARD** (FR)

**C.R.** (IT)

**YALE** (263)

**CCF** (PT)

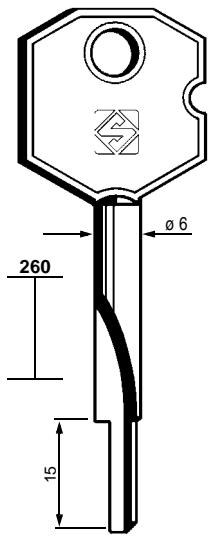

➔  
**XBW5**

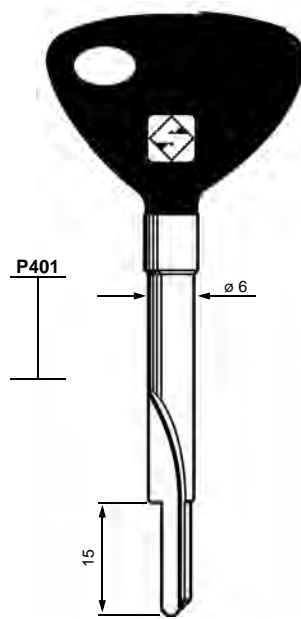

➔  
**XBW5P**

PER:  
FOR:

## BRICARD

## CCF

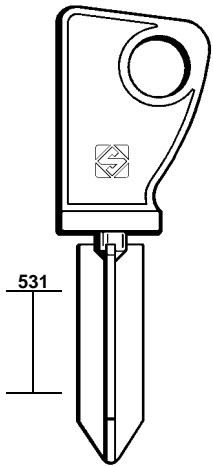

⊕  
**XBD2**

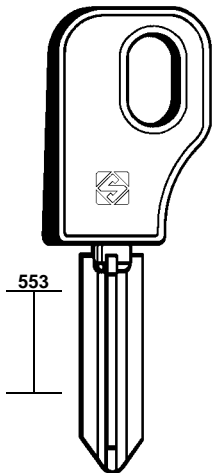

⊕  
**XBD3**

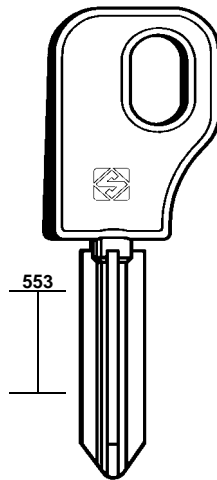

⊕  
**XBD4**

⊕  
**XBD5**

⊕  
**XBD6**

⊕  
**XBD7**

⊕  
**XBD1**

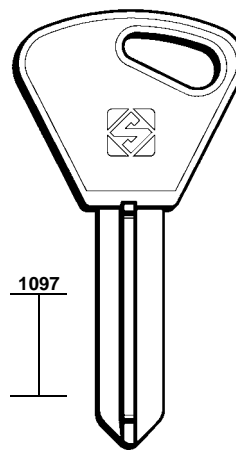

⊕  
**XCCF2**  
CCF5

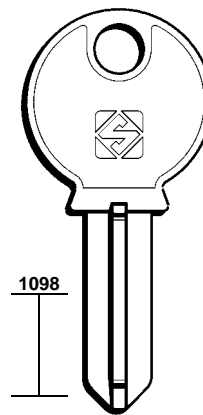

⊕  
**XCCF3**  
CCF4

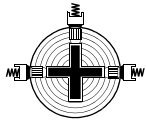

256

PER / FOR

CCF (PT)

CINA (CN)

CRC - CAMBOA (PT)

FAB (CZ)

PER:  
FOR:

CCF

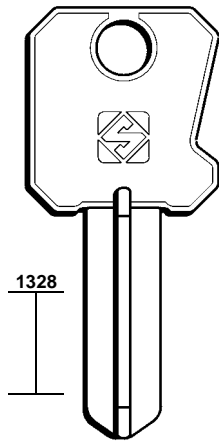

1328

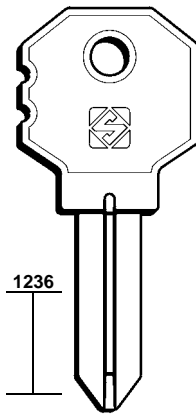

1236

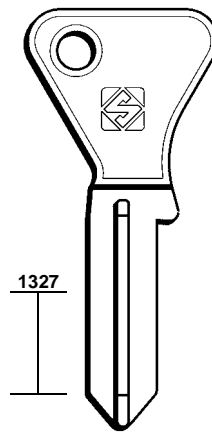

1327

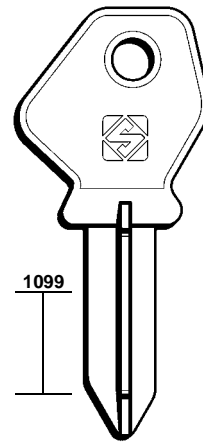

1099

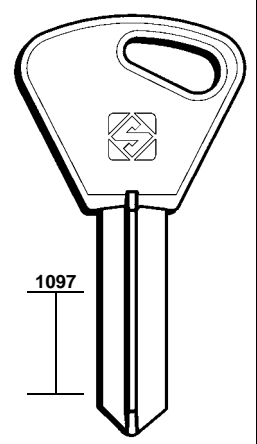

1097



XCCF6  
CCF6



XCCF7  
CCF7



XCCF8  
CCF8



XCCF9  
CCF9



XCCF10  
CCF10

PER:  
FOR:

CINA

CRC-CAMBOA

FAB

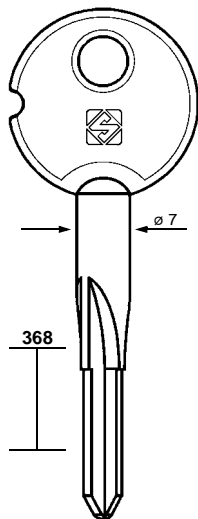

368

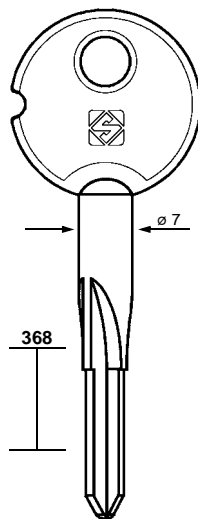

368



XRC1

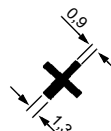

XRC2

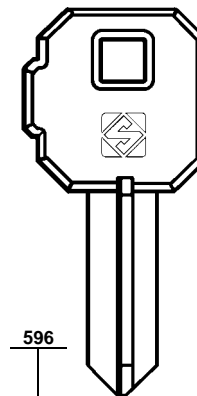

596



XC1

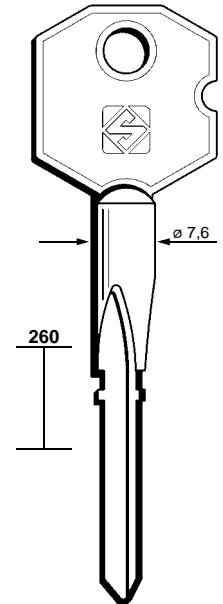

260

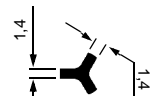

XFB1

PER:  
FOR:

**FAB**

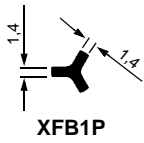
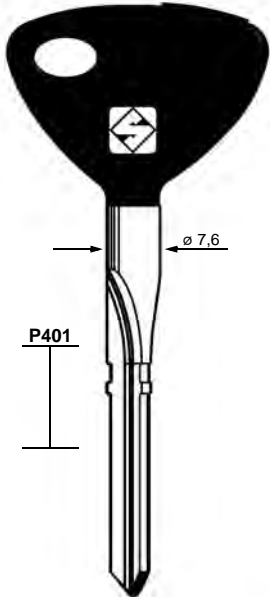

**FIAM**

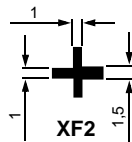
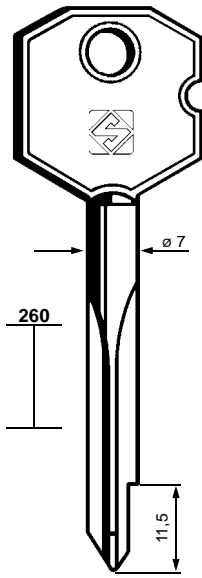
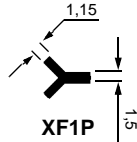
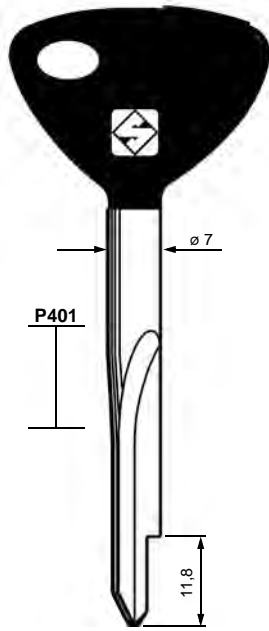

**KALE**

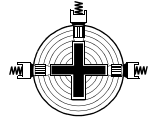
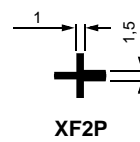
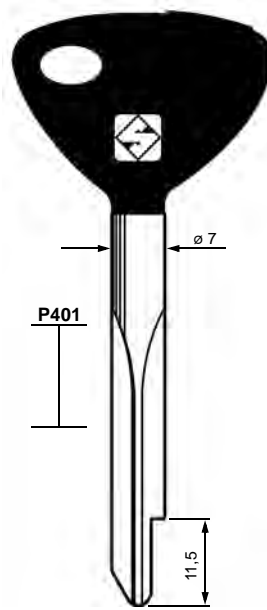

**257**

PER / FOR

**FAB (CZ)**

**FIAM (IT)**

KALE

+ YALE (263)

**FIAM PRÄZIS (IT)**

+ BURGWÄCHTER

(254-255)

+ YALE (263)

**FRIPA (DE)**

**GERA (DE)**

**G.R. (FR)**

(GUERVILLE RIQUIER)

PER:  
FOR:

**FRIPA**

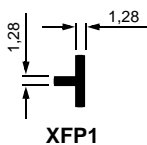
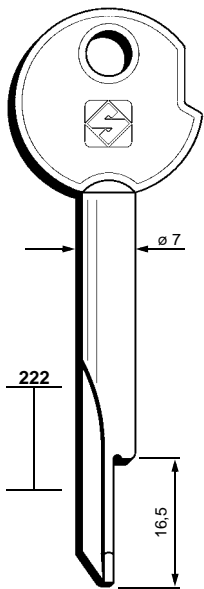

**G.R.**

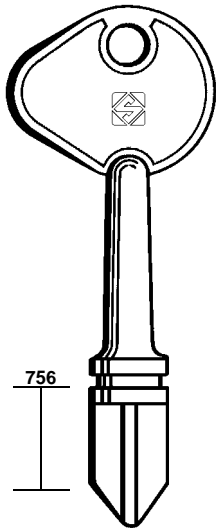

**GUERVILLE-RIQUIER**

**GERA**

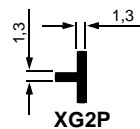
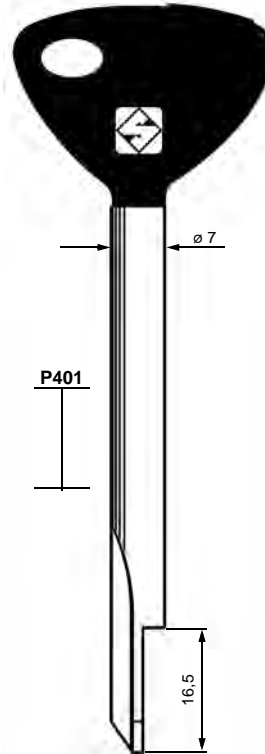
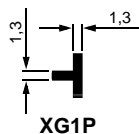
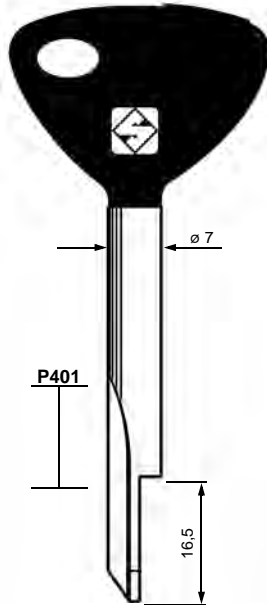

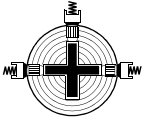

258

PER / FOR

HELCO - KFV (DE)

ISEO (IT)

KALE (TR)

FIAM (257)

PER:  
FOR:

### HELCO - KFV

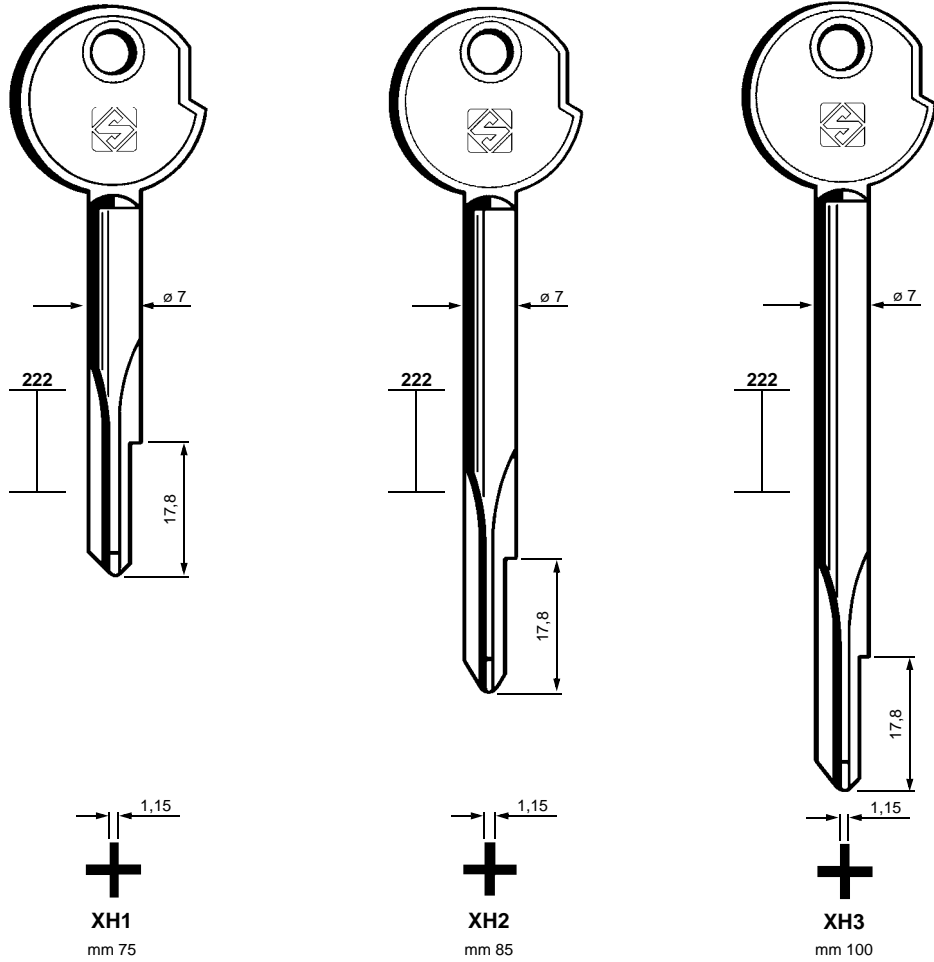

PER:  
FOR:

### ISEO

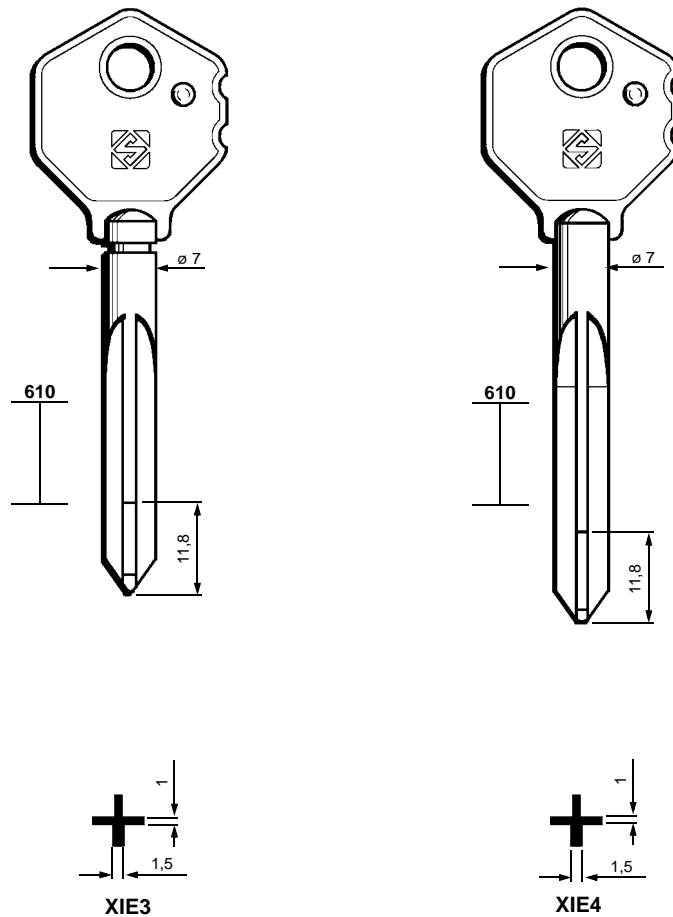

PER:  
FOR:

# KIROV

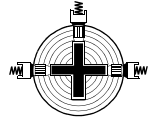

# 259

PER / FOR

**KIROV** (RU)

**LIPS** (NL)

ZEISS - IKON (266)

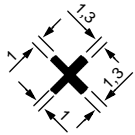
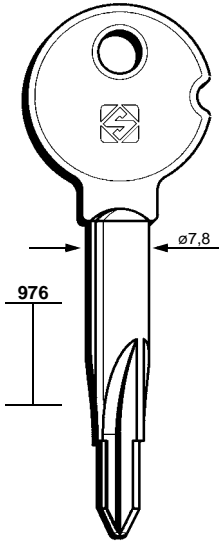

**XKV11**

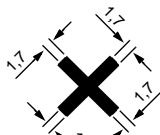
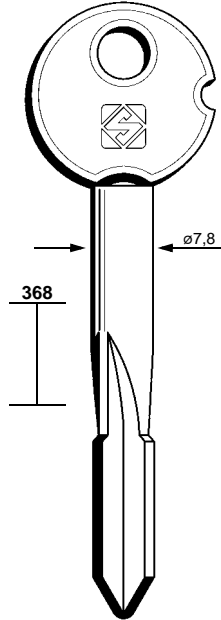

**XKV6**

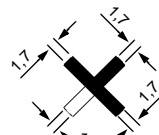
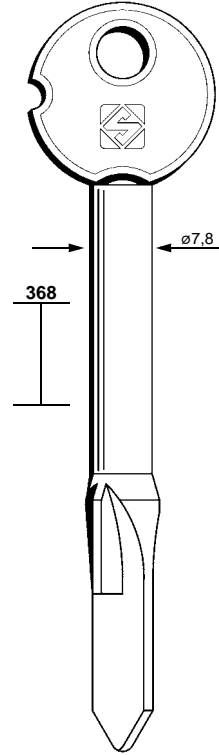

**XKV8**

PER:  
FOR:

# KIROV

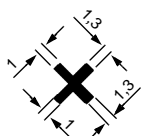
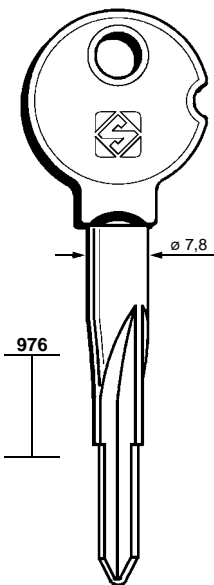

**XKV2**

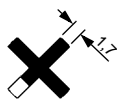
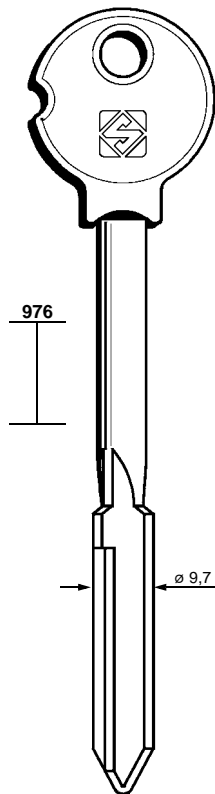

**XKV7**

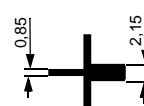
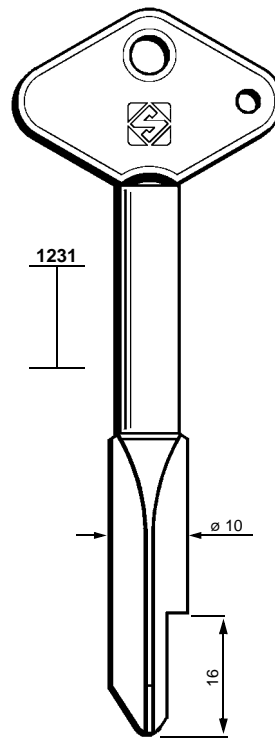

**XKV10**

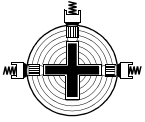

260

PER / FOR

MAFOR (FR)  
RONIS  
SOS

MOBELLA (SE)

MOREAUX (FR)

NABOB (IL)

PER:  
FOR:

MAFOR

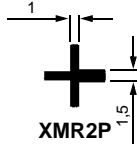
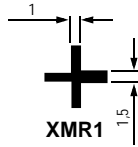
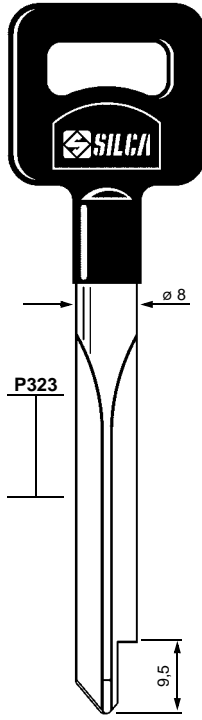
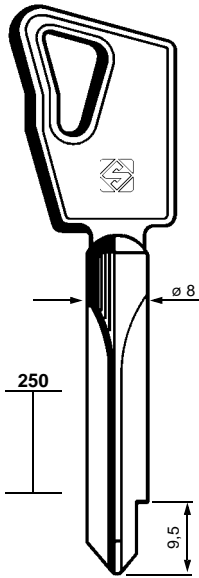

RONIS - SOS

MOBELLA

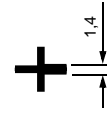
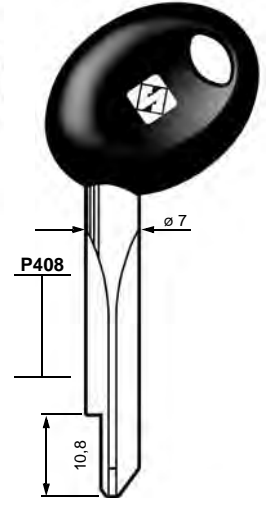
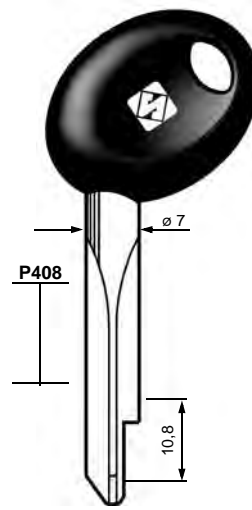

XMBL1P

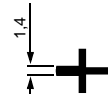

XMBL2P

PER:  
FOR:

MOREAUX

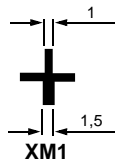
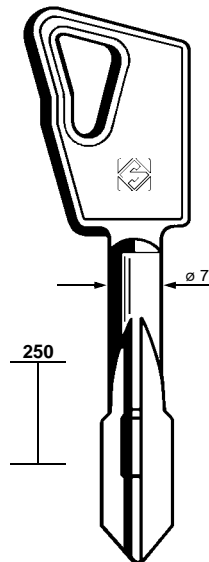
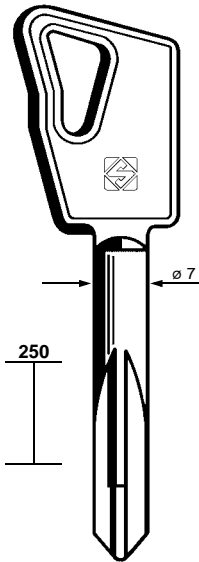

XM1

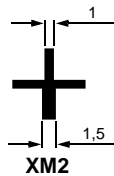

XM2

NABOB

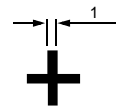
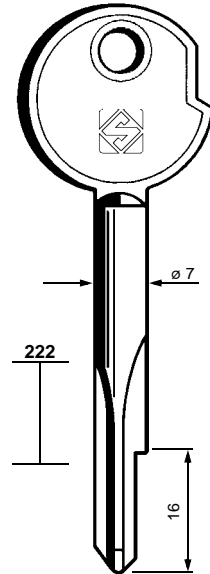

XNA1

PER:  
FOR:

### NEMEF

### OMEC

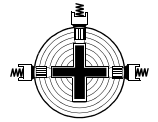

# 261

PER / FOR

NEMEF (NL)

OMEC (IT)

PADO (BR)

PAPAIZ (BR)

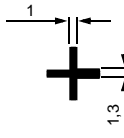
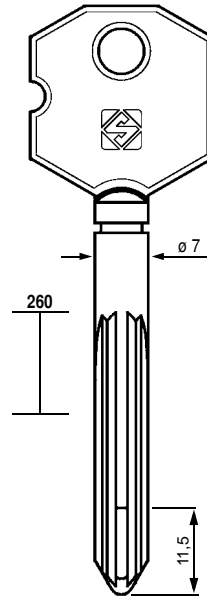
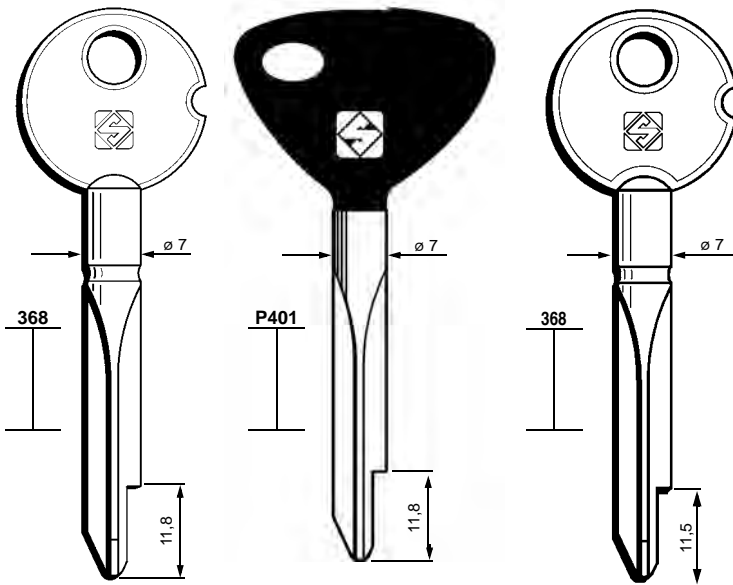

XN1

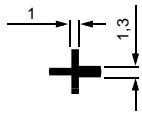

XN1P

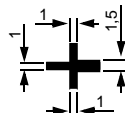

XN3



XOC1

PER:  
FOR:

### PADO

### PAPAIZ

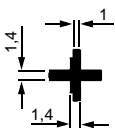
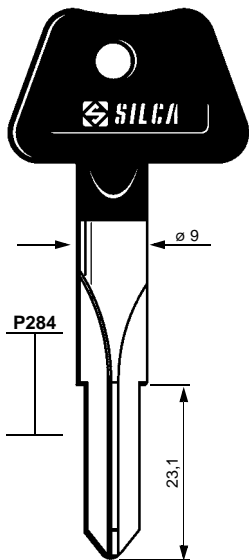

XPDO1P

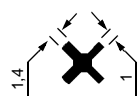
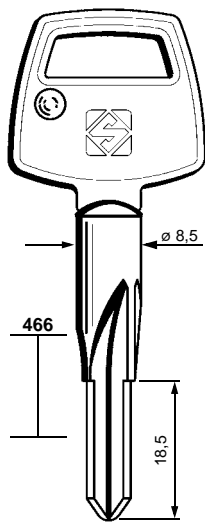

XPZ1

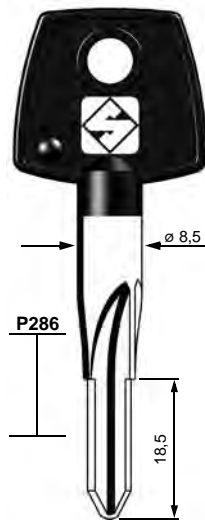

XPZ1P

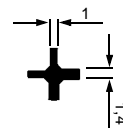
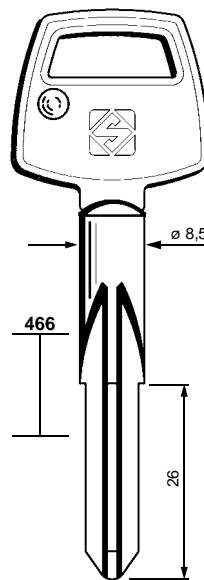

XPZ2

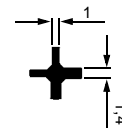
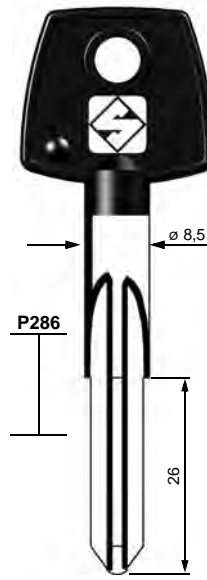

XPZ2P

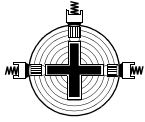

262

PER / FOR

PUNKT (DE)

RONIS (FR)

MAFOR (260)

SELMACH (RU)

STAM (BR)

SOS (FR)

MAFOR (260)

TRIOVING (SE)

BÜRG WÄCHTER (254)

TUFF (HK)

PER: PUNKT

FOR:

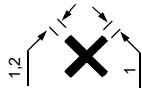
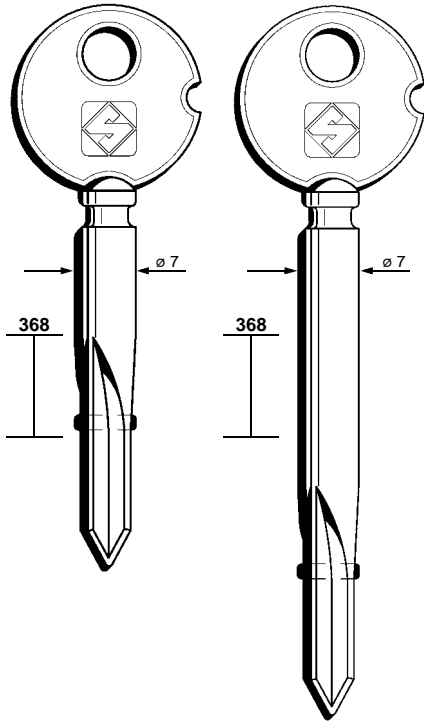

XPK1

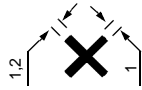

XPK2

PER: SELMACH

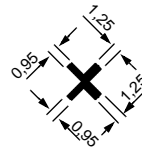
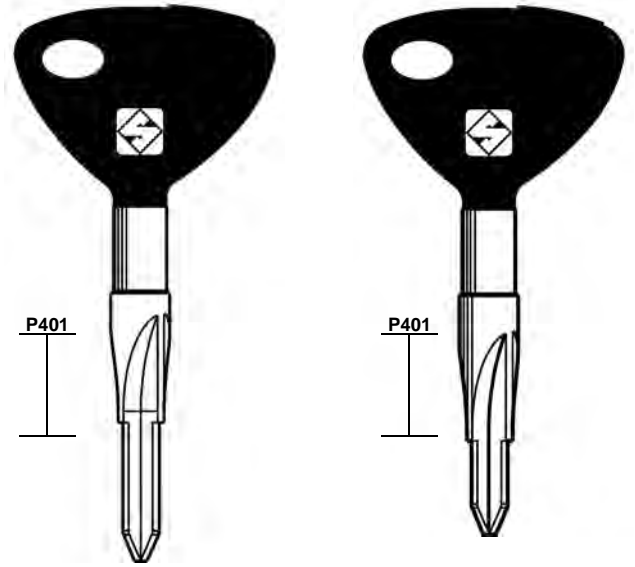

XSLH1P

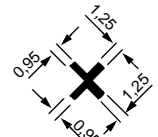

XSLH2P

PER: STAM

FOR:

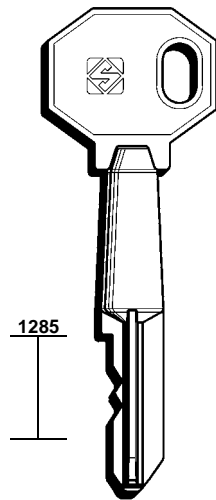

XSAM3

PER: TUFF

FOR:

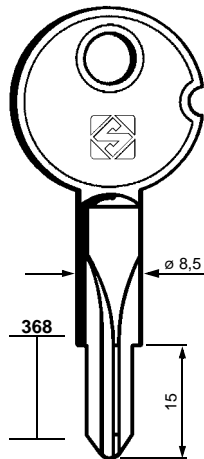

XTF1

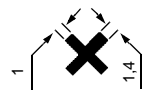
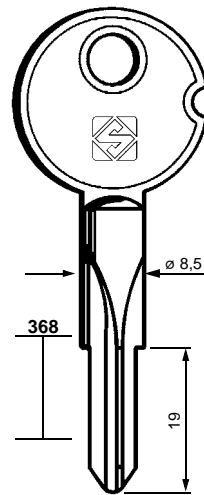

XTF2

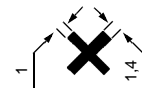
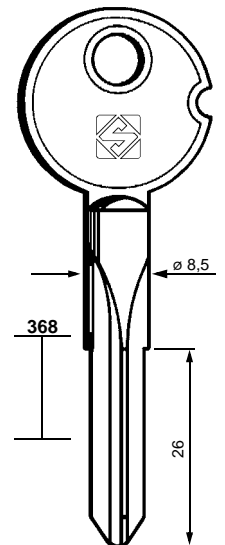

XTF3



PER:  
FOR:

# YALE - BKS

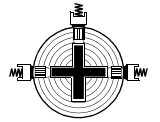

# 263

PER / FOR

YALE (DE)  
BKS

YALE (IT)  
C.R.  
FIAM PRÄZIS

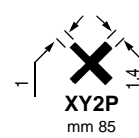
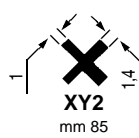
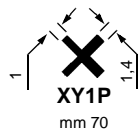
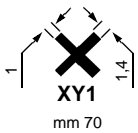
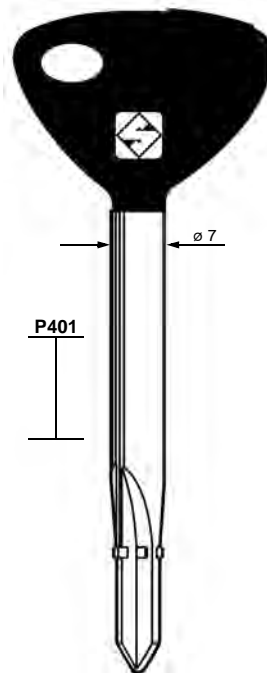
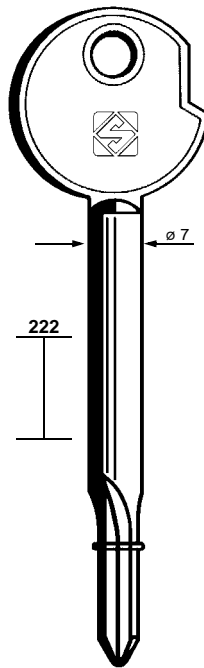
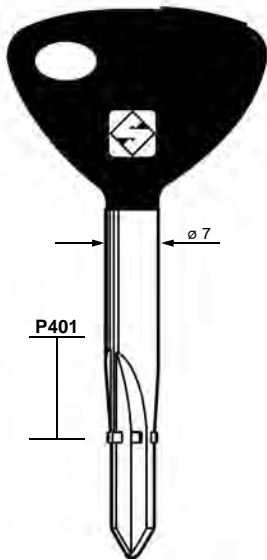
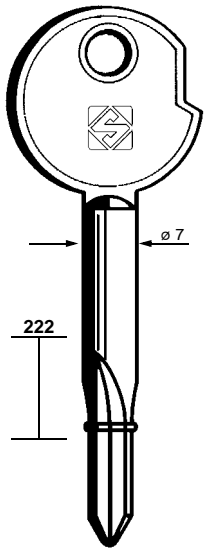

BKS

BKS

PER:  
FOR: YALE - BKS

YALE I

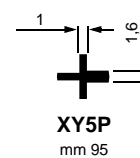
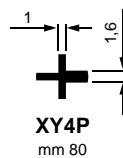
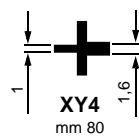
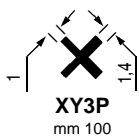
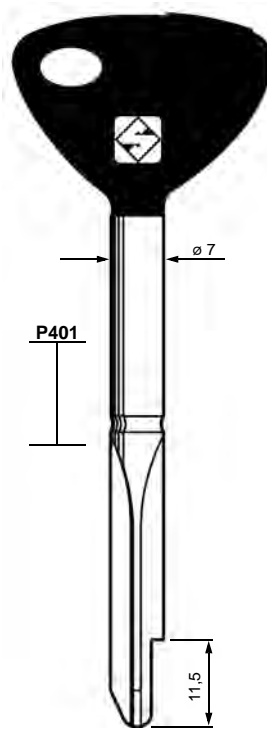
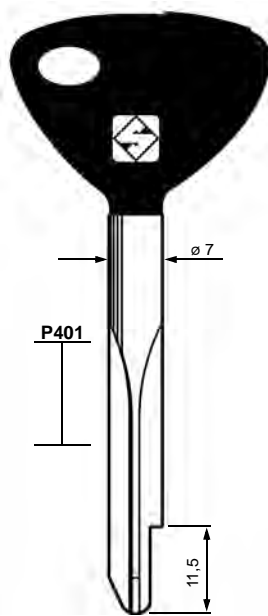
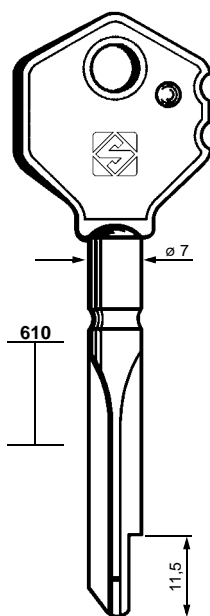
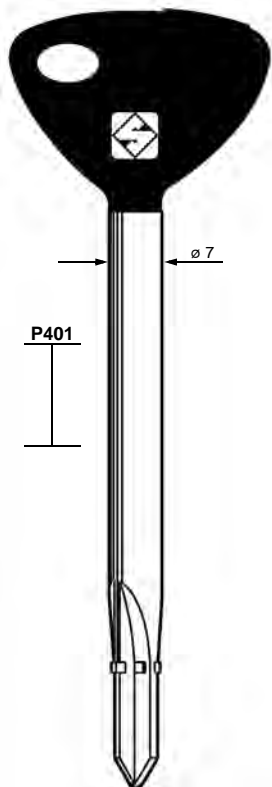

C.R. - FIAM PRÄZIS

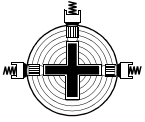

264

PER / FOR

YALE (IT)

YALTRES (AR)

ZASO (TW)

PER:  
FOR:

YALE I

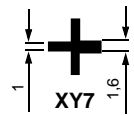
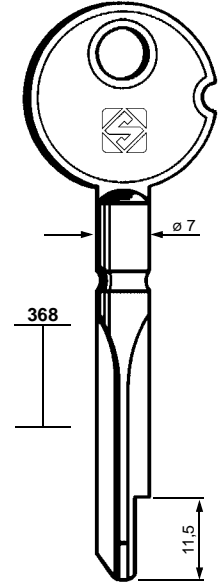
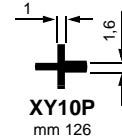
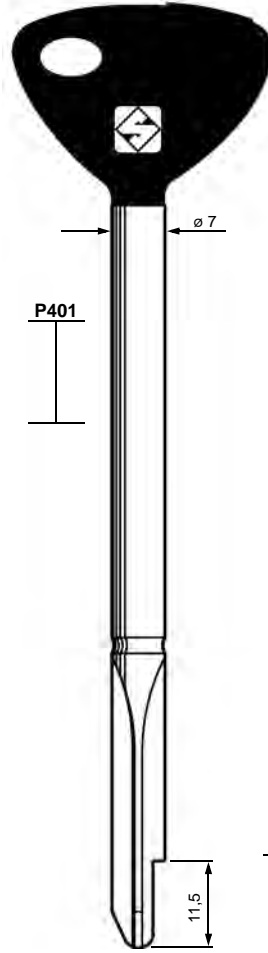
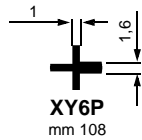
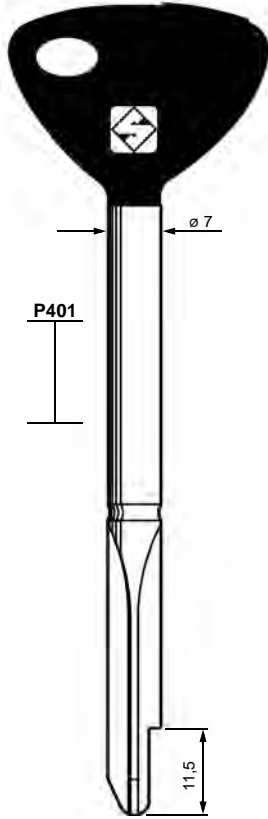

PER:  
FOR:

YALTRES

ZASO

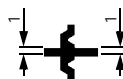
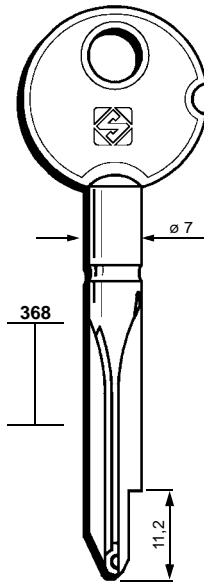
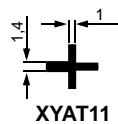
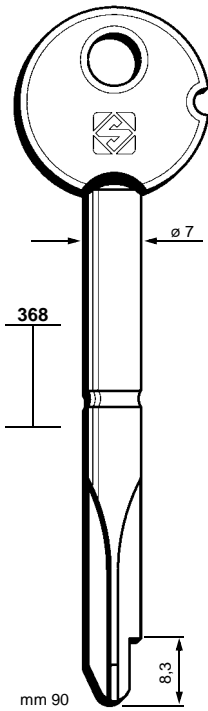

XZAS1

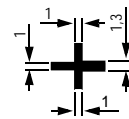
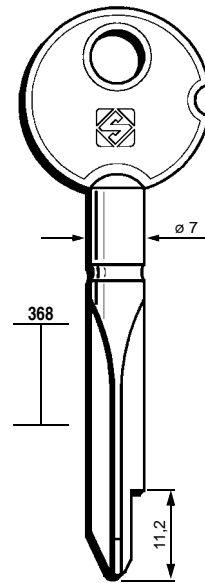

XZAS2

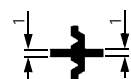
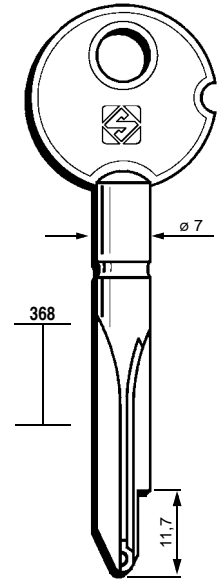

XZAS3

PER:  
FOR:

# ZEISS - IKON

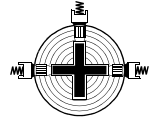

# 265

PER / FOR

ZEISS - IKON (DE)

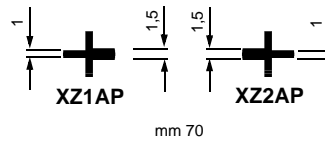
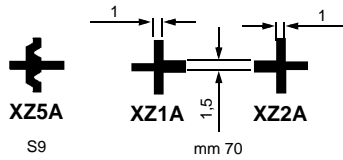
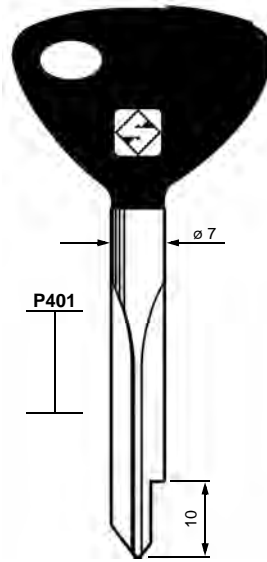
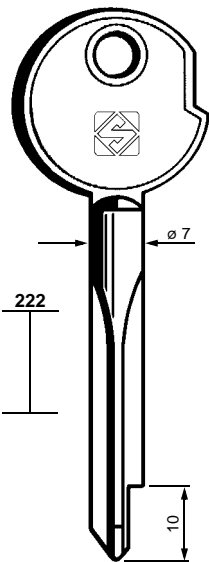

PER:  
FOR:

# ZEISS - IKON

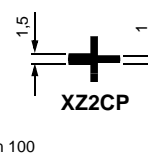
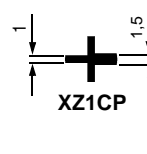
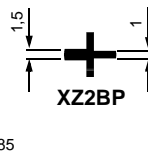
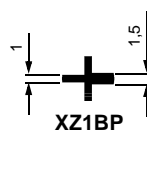
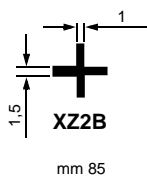
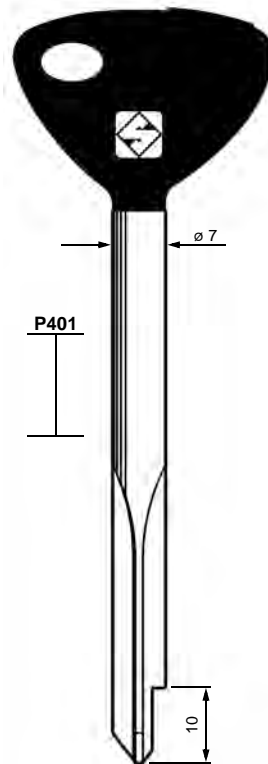
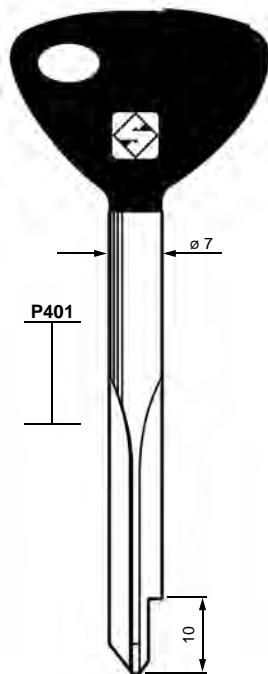
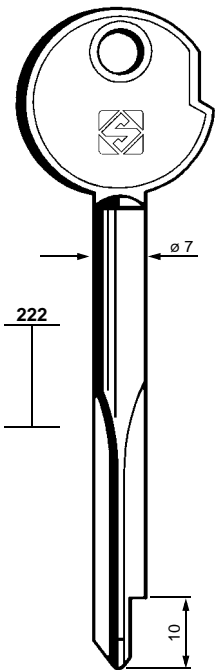

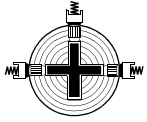

266

PER / FOR

ZEISS - IKON (DE)  
LIPS

PER:  
FOR:

ZEISS - IKON

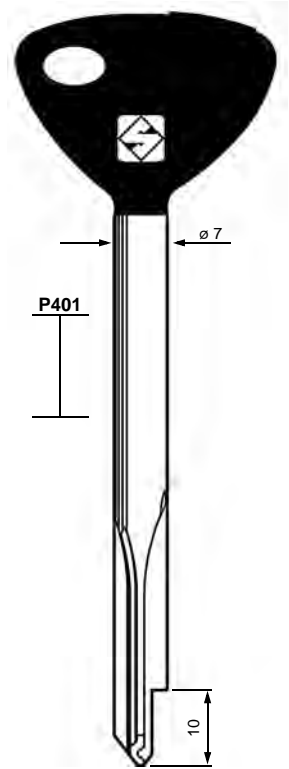
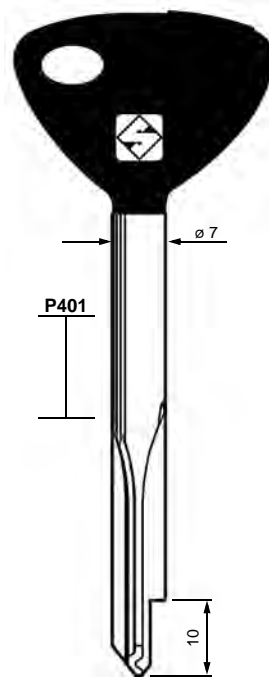
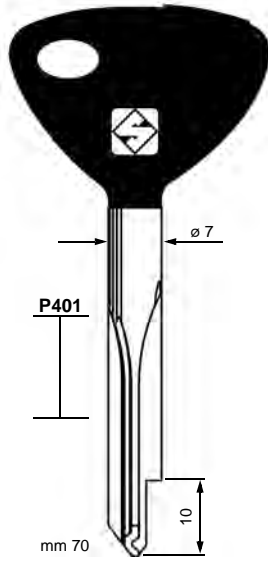
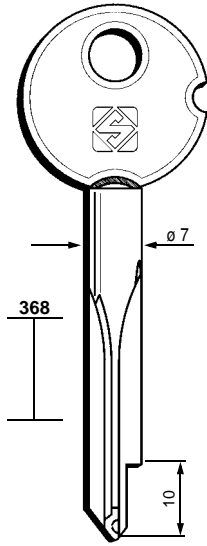

**XZ3A**  
S9  
mm 70

LIPS



**XZ3AP**  
S9

LIPS



**XZ6AP**  
VS9



**XZ3BP**  
S9  
mm 85



**XZ3CP**  
S9  
mm 100

PER:  
FOR:



Mail box and lift keys  
Chiavi per casellari e ascensori  
Fachkästen-und Liftschlüssel  
Clés pour casiers et ascenseurs  
Llaves para casillas y ascensores  
Chaves para caixas de correio e elevadores



PER:  
FOR:



**269**

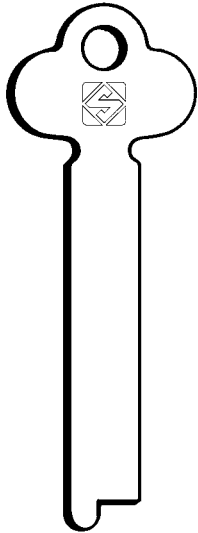

1001

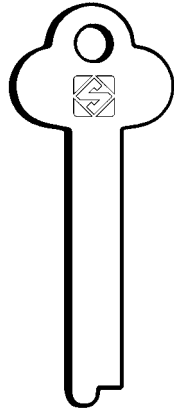

1000

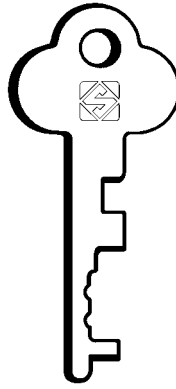

1003P

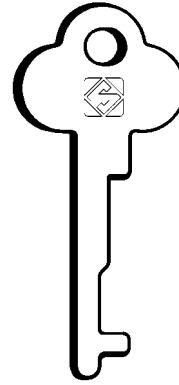

1003P1

PER / FOR

CISA (IT)

I.B.F.M (IT)

J.BEER (GB)  
YALE (269)

MILES (RU)

RIL (PT)

SARGENT (US)

SERRETA (ES)

UNION (GB)

YALE (GB)  
J. BEER

PER: CISA  
FOR:

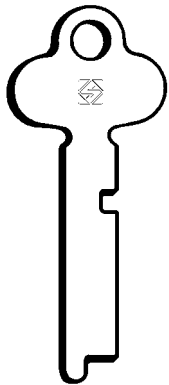

CS1003

I.B.F.M

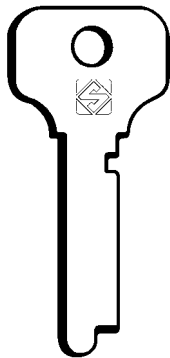

1002

MILES

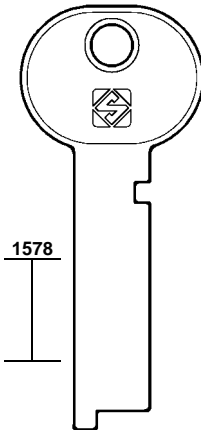

1578

MIS1

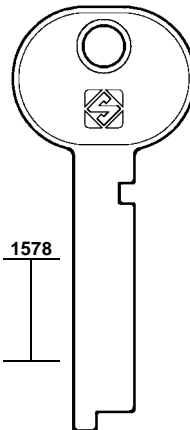

1578

MIS2

RIL

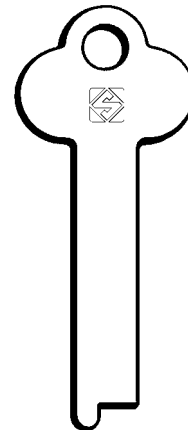

RL1

PER: SARGENT  
FOR:

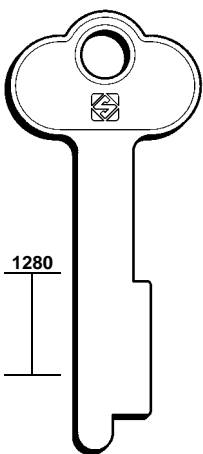

1280

SAR1031

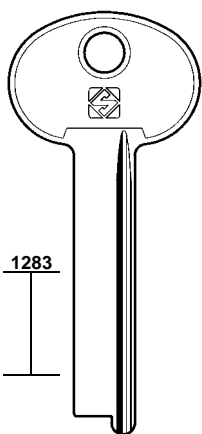

1283

SAR1032

SERRETA

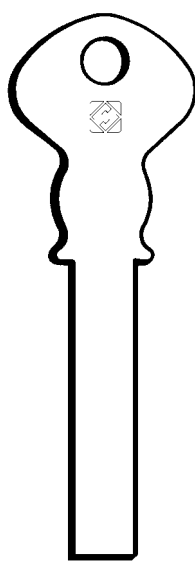

CX7

UNION

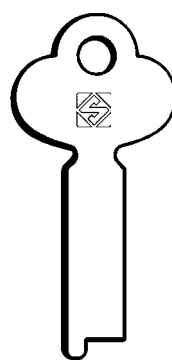

UNI1010

YALE

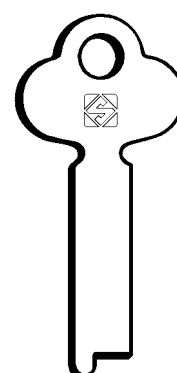

YA1007

J. BEER



# 270

PER / FOR

CASELLARIO (IT)

COUILLET (FR)

CUIRASSEE (FR)

PER:  
FOR:

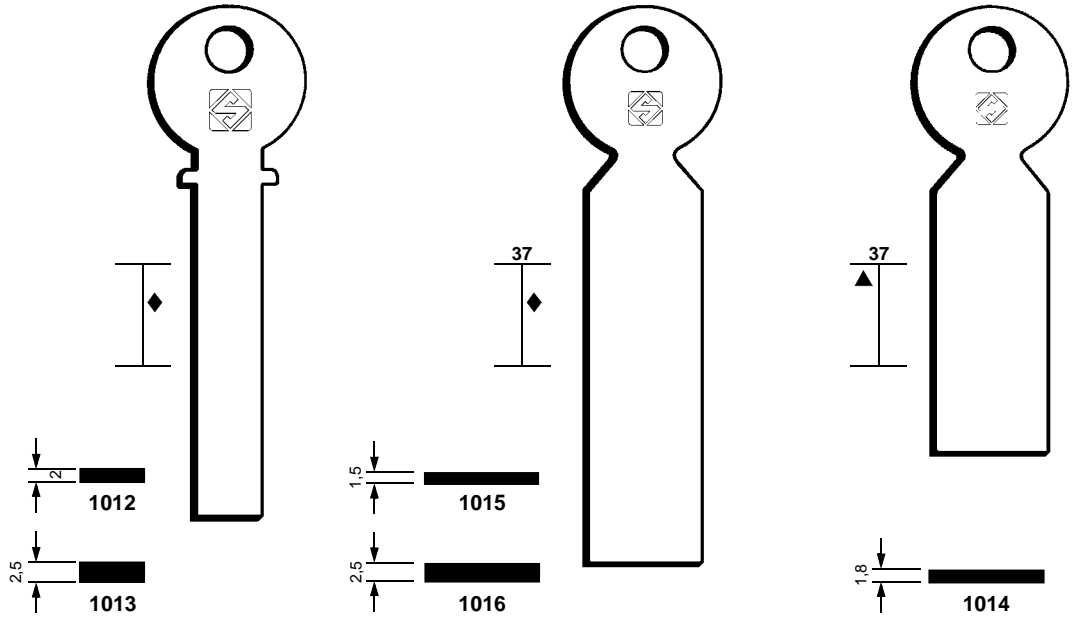

PER:  
FOR:

## COUILLET

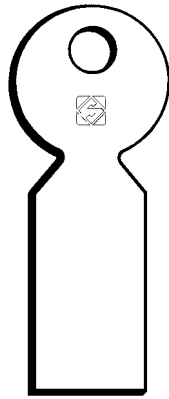

- |  |       |  |       |
|--|-------|--|-------|
|  | CU401 |  | CU409 |
|  | CU402 |  | CU410 |
|  | CU403 |  | CU411 |
|  | CU404 |  | CU412 |
|  | CU405 |  | CU413 |
|  | CU406 |  |       |
|  | CU407 |  |       |
|  | CU408 |  |       |

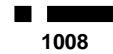
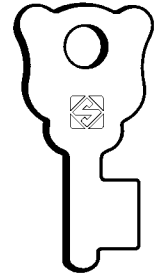
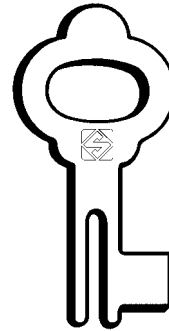

1008



1009

PER:  
FOR:

## CASELLARIO

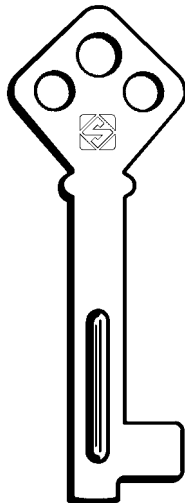

- |  |               |
|--|---------------|
|  | 1004          |
|  | Right/Destro  |
|  | 1005          |
|  | Left/Sinistro |

## CUIRASSEE

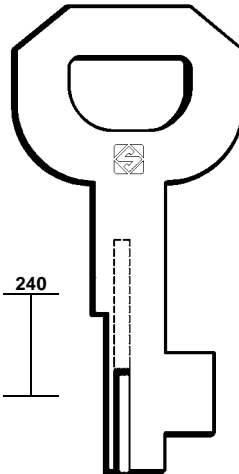

240

- |  |        |
|--|--------|
|  | CRE401 |
|  | CRE402 |
|  | CRE403 |

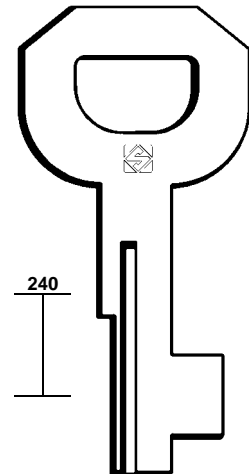

240

- |  |        |
|--|--------|
|  | CRE404 |
|  | CRE405 |
|  | CRE406 |



PER:  
FOR:

### MOBELLAS

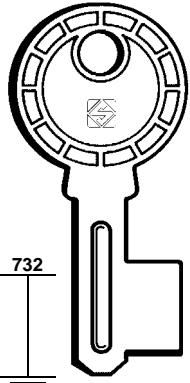

732

453  
622

#### MBS300

- ..... (SER11) 22001-22750
- ..... (SER12) 17501-18250
- ..... (SER13) 16001-16750
- ..... (SER14) 18251-19000
- ..... (SER15) 16751-17500
- ..... (SER21) 11501-12250
- ..... (SER22) 24251-25000
- ..... (SER23) 10751-11500
- ..... (SER24) 12251-13000
- ..... (SER25) 10001-10750
- ..... 1-2-3-4-5
- ..... 1-2-3-4-5

#### MBS301

- ..... (SER11) 40751-41500
- ..... (SER12) 36251-37000
- ..... (SER13) 34751-35500
- ..... (SER14) 37001-37750
- ..... (SER15) 35501-36250
- ..... (SER21) 30251-31000
- ..... (SER22) 43001-43750
- ..... (SER23) 29501-30250
- ..... (SER24) 31001-31750
- ..... (SER25) 28751-29500
- ..... 1-2-3-4-5
- ..... 1-2-3-4-5

### MUEL

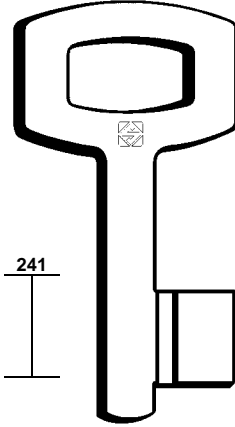

241



MU401



MU402

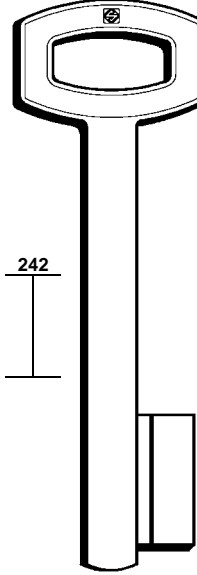

242



MU403



MU404

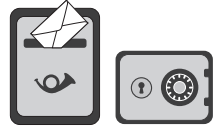

# 271

PER / FOR

MOBELLAS (SE)

MUEL (FR)

BODE (DE)

HEERUM (DE)

KROMA (DE)  
OSTERTAG (271)

OSTERTAG (DE)  
KROMA

STUV (DE)

PER:  
FOR:

### BODE

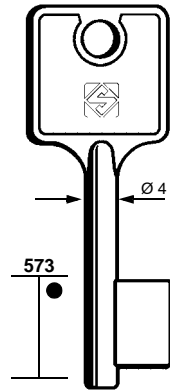

573



6BDE1

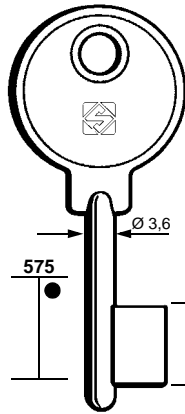

575



6BDE2

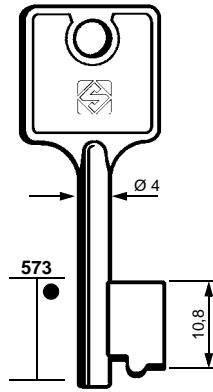

573



6BDE3

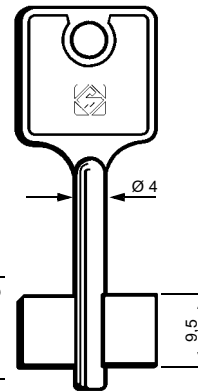

573



5BDE1

PER:  
FOR:

### HEERUM

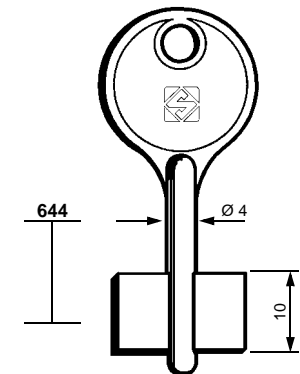

644



5HRM1

### OSTERTAG

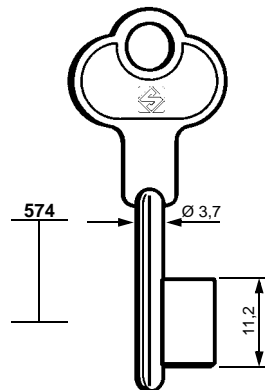

574



6OG1

KROMA

### STUV

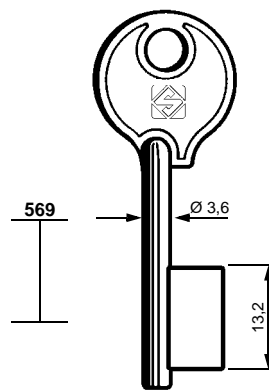

569



6SV1



272

PER / FOR

BASSETTI (IT)

BELLOMO (IT)

STIGLER (273)

BONFEDI (IT)

BOSISIO (IT)

FALCONE (IT)

FIAM (IT)

INSUBRIA (IT)

PER:  
FOR:

BASSETTI

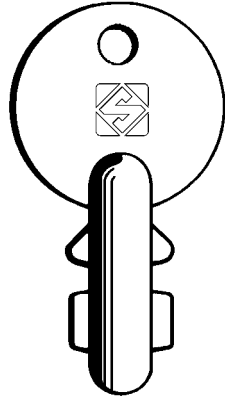

ABA1

BONFEDI

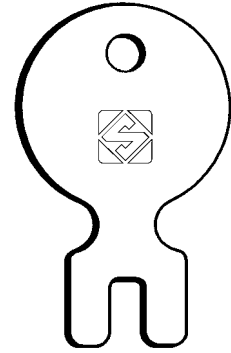

ABO1  
Modified/Modificato

PER:  
FOR:

BONFEDI

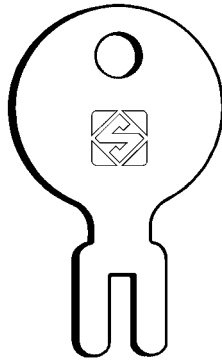

ABO2  
Normal/Normale

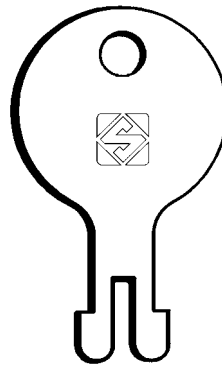

ABO3  
To cut out/Ritagliato

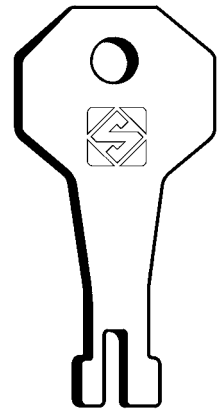

ABO4

PER:  
FOR:

BOSISIO

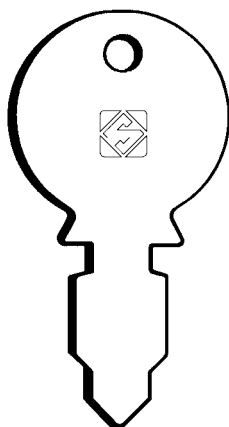

ABOS1

FALCONE

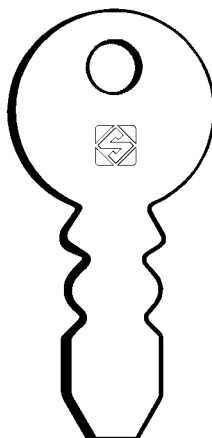

AFA1

FIAM

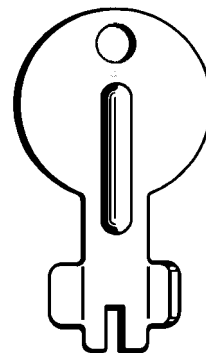

AF1  
Universal/Universale

INSUBRIA

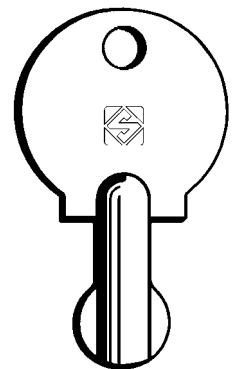

AIN1

PER:  
FOR: **MANETTI**

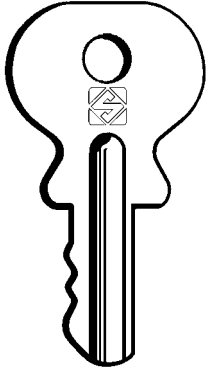

  
AMA1

**PERINO**

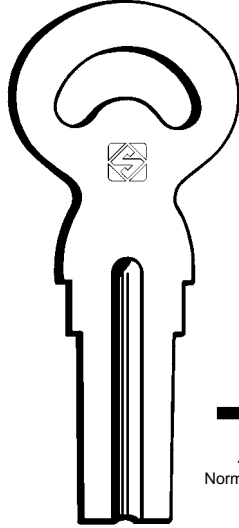

  
APE1  
Normal/Normale

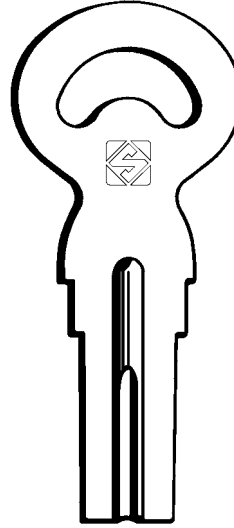

  
APE2

  
APE1F



**273**

PER / FOR

MANETTI (IT)

PERINO (IT)

ROMA (IT)

SABIEM (IT)

SAFOV (IT)

S.I.C.E.M. (IT)

STIGLER (IT)  
BELLOMO

PER:  
FOR: **ROMA**

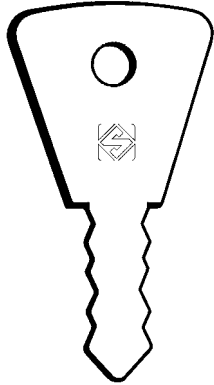

  
ARO1

**SABIEM**

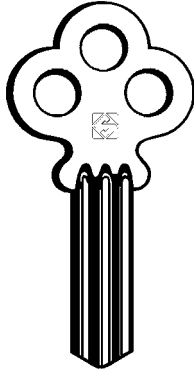

  
ASAB1

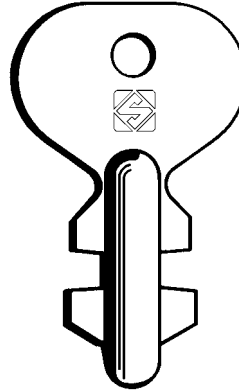

**SAFOV**

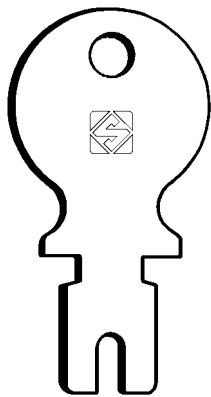

  
ASAF1  
Modified/Modificato

PER:  
FOR: **S.I.C.E.M**



  
ASI1  
  
ASI2

**STIGLER - BELLOMO**

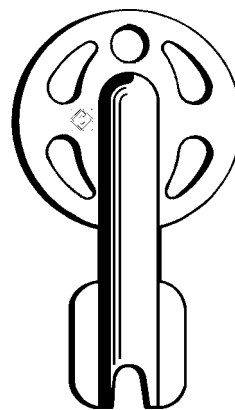

  
AST1





General index  
Indice generale  
Generalverzeichnis  
Index général  
Indice general  
Índice geral

REF.		PAGE	REF.		PAGE	REF.		PAGE
<b>1</b>			AA5R	● ▲	14	AB23	▲	8-100
1000	◆	269	AA6	● ▲	14	AB23R	● ▲	8-100
1001	◆	269	AA6R	● ▲	14	AB24	▲	8
1002	◆	269	AAA1	● ▲ U	4	AB25R	▲	6
1004	◆	270	AAB1	●	4	AB26	▲	6
1005	◆	270	AB1	● ▲ U	6	AB27	● ▲ U	8
1008	◆	270	AB1R	▲ U	7	AB29R	▲	8
1009	◆	270	AB1RX	▲	7	AB30	● ▲	8
1012	◆	269	AB1X	● ▲ U G S	7	AB30R	● ▲	8
1013	◆	269	AB2	● ▲	7	AB31	▲	8
1014	◆	269	AB2R	● ▲	7	AB32	● ■	6
1015	◆	269	AB3	● ▲	7	AB33	▲	6
1016	◆	269	AB3R	● ▲	7	AB34	▲	6
1003P	◆	269	AB4	▲	7	AB35	▲	8
1003P1	◆	269	AB5	● ▲	7	AB35R	● ▲	8
<b>4</b>			AB6	▲	7	AB36	▲	6
454	● ▲	54	AB7	● ▲	7	AB36R	▲	6
<b>5</b>			AB8	▲	6	AB37	▲	6
5BDE1	●	270	AB8R	▲	6	AB37R	● ▲	6
5HRM1	●	270	AB9	● ▲	7	AB38P	● ■	6
<b>6</b>			AB10	● ▲	6	AB39	▲	8
6BDE1	●	270	AB10R	● ▲	6	AB39R	▲	8
6BDE2	●	270	AB11	● ▲	7	AB40	● ▲	10-225
6BDE3	●	270	AB11R	● ▲	7	AB41R	● ▲	8
6OG1	●	270	AB12	● ▲	8	AB42R	▲	6
6SV1	●	270	AB12R	● ▲	8	AB43	● ▲	8
<b>A</b>			AB13	● ▲	8	AB43R	● ▲	8
A303	● ▲	54	AB13R	▲	8	AB44	● ▲	6
AA1	● ▲	14	AB14	● ▲ U	7	AB44R	● ▲	6
AA1R	● ▲	14	AB14R	● ▲	7	AB45	● ▲	8
AA2	●	14	AB15	▲	8	AB46	▲	9
AA2R	●	14	AB15R	● ▲	8	AB47R	▲	6
AA3	●	14	AB16	● ▲	8	AB48	● S	10-225
AA3R	●	14	AB16R	● ▲	8	AB50	● ▲	9
AA4	● ▲	14	AB17	● ▲	8	AB51	▲	9
AA4R	● ▲	14	AB17R	● ▲	8	AB52	● ▲	9
AA5	● ▲	14	AB18	● ▲	7	AB53	● ▲	9
			AB19	● ▲ U	7	AB54	● ▲	9
			AB20	▲	7	AB55X	▲	7
			AB21	▲	6	AB56	▲	9
			AB21R	▲	6	AB56AP	▲	9
			AB22	▲	6	AB56R	▲	9

● Brass  
Ottone  
Messing  
Laiton  
Latón  
Latão

▲ Steel  
Acciaio  
Stahl  
Acier  
Acero  
Aço

■ Nickel silver  
Alpacca  
Neusilber  
Maillechort  
Alpaca  
Alpaca

◆ Iron  
Ferro  
Eisen  
Fer  
Hierro  
Ferro

Ⓒ Available in Color  
Disponibile in Color  
Lieferbar in Color  
Disponibile en Color  
Disponibile en Color  
Disponível em Color

Ⓒ Available in Ultralite  
Disponibile in Ultralite  
Lieferbar in Ultralite  
Disponibile en Ultralite  
Disponibile en Ultralite  
Disponível em Ultralite

Ⓒ Available in Silky  
Disponibile in Silky  
Lieferbar in Silky  
Disponibile en Silky  
Disponibile en Silky  
Disponível em Silky

REF.		PAGE	REF.		PAGE	REF.		PAGE
AB57AP	▲	9	AB104R	●	6	AG9	▲	13
AB57RAP	▲	9	AB105R	▲	10	AG9R	▲	13
AB58AP	▲	9	AB109	●	10	AG10	●▲	13
AB58RAP	▲	9	ABA1	◆	270	AGA1	▲	11
AB59RAP	▲	9	ABO1	◆	270	AGA1R	▲	11
AB60P	●■	6	ABO2	◆	270	AGA2	▲	11
AB61	●	7	ABO3	◆	270	AGA2R	▲	11
AB62	●	10-225	ABO4	◆	270	AGA3	▲	11
AB63	●	6	ABOS1	◆	270	AGA4	▲	11
AB64RAP	●	9	AC1	▲	4	AGA4R	▲	11
AB65RAP	●	9	AC2	▲	4	AGA5	▲	11
AB66R	▲	10	ACR1	●▲U	17	AGA5R	▲	11
AB67	●	6	ACR2	●	17	AGA6	▲	11
AB68X	▲	7	ACR3	●	17	AGA7	●	11-225
AB69X	▲	7	ACR4	●	17	AGA8	▲	11
AB70X	▲	7	AD1	●	11	AGA9	●	11-225
AB71	▲	9	AD2	▲	11	AGA25	▲	11
AB72	▲	7	ADT1	▲	11	AGA25R	▲	11
AB72R	▲	7	AE1R	●▲	14	AGB1	●▲■U	11
AB74	●	10-225	AE2R	●▲	14	AGB1R	●▲UCS	11
AB75	●	6	AEP1	●▲	11	AGB2	●▲U	12
AB76	▲	9	AEP2	●▲	11	AGB2R	●▲U	12
AB76R	▲	9	AF4C	●▲	112	AGB3	●▲	12
AB77	●	10-225	AF4D	●▲	112	AGB3R	●▲U	12
AB78R	▲	6	AFA1	◆	270	AGB4	●▲	12
AB79RX	▲	7	AF11	◆	270	AGB4R	●▲	12
AB81	●	8	AG1	●▲	13	AGB5	●■CS	12-225
AB83	●▲	7	AG1R	▲	13	AGB6	●	12-226
AB84	●	10-225	AG2	●▲	13	AGB7	●	12-226
AB85	●	9	AG2R	●▲C	13	AGB8	●CS	12-225
AB86	▲	7	AG3	●▲G	13	AGB9	●S	12-225
AB88X	▲	7	AG3R	●▲	13	AGE1	●▲U	12
AB89	●▲	10	AG4	●▲	13	AGE1R	▲	12
AB90R	▲	9	AG4R	●▲	13	AGE2	▲	12
AB91	▲	10	AG5	▲	13	AGE3	▲	12
AB93R	▲	9	AG5R	▲	13	AGE4R	●▲	12
AB95	▲	10	AG6	●▲	13	AGE5R	▲	12
AB98	▲	10	AG6R	●▲	13	AGE6	▲	12
AB100	▲	10	AG7	●▲	13	AGN1	●	13-226
AB100R	▲	10	AG7R	●▲	13	AH1	▲	17
AB101RX	▲	7	AG8	▲	13	AHR2	●	13-226
AB102	▲	9	AG8R	▲	13	AI1	●U	15

● Brass  
Ottone  
Messing  
Laiton  
Latón  
Latão

▲ Steel  
Acciaio  
Stahl  
Acier  
Acero  
Aço

■ Nickel silver  
Alpacca  
Neusilber  
Maillechort  
Alpaca  
Alpaca

◆ Iron  
Ferro  
Eisen  
Fer  
Hierro  
Ferro

Ⓒ Available in Color  
Disponibile in Color  
Lieferbar in Color  
Disponibile en Color  
Disponibile en Color  
Disponível em Color

Ⓘ Available in Ultralite  
Disponibile in Ultralite  
Lieferbar in Ultralite  
Disponibile en Ultralite  
Disponibile en Ultralite  
Disponível em Ultralite

Ⓔ Available in Silky  
Disponibile in Silky  
Lieferbar in Silky  
Disponibile en Silky  
Disponibile en Silky  
Disponível em Silky

REF.		PAGE	REF.		PAGE	REF.		PAGE
AI2	●	15	ALP16	●	16-226	ASAF1	◆	271
AIN1	◆	270	ALU1	●	16	ASEC1	● ▲	14
AKR1	● ▲ U	17	AMA1	◆	270	ASEC2	● ▲	15
AKR2	● ▲ U	17	AMC1R	●	16	ASI1	◆	271
AKR3	▲	17	AMC2R	●	16	ASI2	◆	271
AKR3R	▲	17	AMC3	●	17	ASN1	● ▲	20
AKR4	▲	18	AMG1R	●	17-226	ASS2	● ▲ U	22
AKR5	▲	18	AMG2R	●	17-226	ASS2R	● ▲	22
AKR6	▲	17	AMG3R	●	17-226	ASS3	●	23
AKR7	● ▲	17	AN1	▲	18	ASS3R	●	23
AKR8	● ▲	18	AN1R	● ▲	18	ASS4	●	24
AKR9R	▲	18	APA1R	▲	20	ASS4R	● ▲	24
AKR10	● ▲	18	APA2R	●	20	ASS6	● ▲ U	21-181
AKR11R	● ▲	18	APE1	◆	270	ASS6R	● ▲ U	21-181
AKR14	●	18	APE1F	◆	270	ASS7	● ▲	22
AKR15	●	18	APE2	◆	270	ASS8	● ▲	24
AKR16R	▲	18	APK1	▲	18	ASS8R	●	24
AL1	● ▲ U	13	APK2R	●	18-226	ASS9	● ▲	22
AL1R	▲	13	APK3R	●	18-226	ASS9R	● ▲	22
ALA1R	● ▲	15	APK4	●	18-226	ASS10	● ▲	22
ALA2R	▲	15	APK5R	●	18-226	ASS10R	● ▲	22
ALK1	●	15	AQ1	▲	19	ASS11	● ▲	22
ALK2	●	15	AQ1R	● ▲	19	ASS11R	● ▲	22
ALM1	▲	16	AQ2	▲	19	ASS12	● ▲	23
ALM1R	▲	16	AQ2R	▲	19	ASS13	▲	22
ALP1	● ▲	15	AQ3	▲	19	ASS13R	● ▲	22
ALP2	●	15	AQ3R	▲	19	ASS14	●	24
ALP3	▲	15	AQ4	▲	19	ASS15	● ▲	22
ALP4	● ▲	16	AQ4R	▲	19	ASS15R	● ▲	22
ALP4R	● ▲	16	ARE1	● ▲	19	ASS16	●	24
ALP5R	● ▲	16	ARF1	▲	19	ASS16R	●	24
ALP6R	● ▲	16	ARG1R	▲	19	ASS17	● ▲	22
ALP7R	▲	16	ARG2R	▲	19	ASS18R	●	24
ALP8R	● ▲	16	ARL1	● ▲	19	ASS19	● ▲	22
ALP9	● ▲	16	ARL1R	▲	19	ASS19R	● ▲	22
ALP9R	● ▲	16	ARO1	◆	270	ASS20	●	24
ALP10	● ▲	15	ARS1	▲	20	ASS20R	●	24
ALP11	▲	15	ARS2	▲	20	ASS21	● ▲	22
ALP12	●	16	ART1	● ▲	19	ASS21R	● ▲	22
ALP13R	●	16	ART1R	● ▲	19	ASS22	●	24
ALP14R	●	16	AS1	● ▲	20-54	ASS22R	●	24
ALP15R	●	16	ASAB1	◆	271	ASS23	● ▲	22

● Brass  
Ottone  
Messing  
Laiton  
Latón  
Latão

▲ Steel  
Acciaio  
Stahl  
Acier  
Acero  
Aço

■ Nickel silver  
Alpaca  
Neusilber  
Maillechort  
Alpaca  
Alpaca

◆ Iron  
Ferro  
Eisen  
Fer  
Hierro  
Ferro

Ⓒ Available in Color  
Disponibile in Color  
Lieferbar in Color  
Disponibile en Color  
Disponibile en Color  
Disponível em Color

Ⓒ Available in Ultralite  
Disponibile in Ultralite  
Lieferbar in Ultralite  
Disponibile en Ultralite  
Disponibile en Ultralite  
Disponível em Ultralite

Ⓒ Available in Silky  
Disponibile in Silky  
Lieferbar in Silky  
Disponibile en Silky  
Disponibile en Silky  
Disponível em Silky



Articles and materials general index / Índice Generale articoli e materiali / Allgemeines Artikel- und Materialverzeichnis / Table des matières des articles et des matériaux / Índice general de los artículos y de los materiales / Índice geral dos artigos e dos materiais

REF.		PAGE	REF.		PAGE	REF.		PAGE
ASS23R	● ▲	22	ASS48R	● ▲	24	ASS82R	●	24
ASS24	●	24	ASS50	●	25	ASS84	● ▲	25
ASS24R	●	24	ASS50R	●	25	ASS84R	●	25
ASS25	● ▲	22	ASS51	●	25	ASS85	● ▲	25
ASS25R	● ▲	22	ASS51R	●	25	ASS85R	● ▲	25
ASS26	●	24	ASS52	● ■	25	ASS86	▲	25
ASS26R	●	24	ASS52R	● ▲ ■ U	25	ASS86R	● ▲	25
ASS27	● ▲	22	ASS53	●	23	ASS87	●	25
ASS27R	● ▲	22	ASS53R	●	23	ASS87R	● ▲	25
ASS28	●	24	ASS55	●	25	ASS88	●	25
ASS28R	● ▲	24	ASS55R	● ▲	25	ASS88R	●	25
ASS29	● ▲	22	ASS56	●	25	ASS90	▲	24
ASS29R	● ▲	22	ASS56R	●	25	ASS90R	● ▲	24
ASS30	●	24	ASS63	● ▲	21	ASS91	●	25
ASS30R	●	24	ASS63R	▲	21	ASS91R	●	25
ASS31	● ▲	22	ASS64	● ▲	22	ASS92	▲	25
ASS31R	● ▲	22	ASS64R	● ▲	22	ASS92R	● ▲	25
ASS32	● ▲	23	ASS65	● ▲	22	ASS93	●	25
ASS32R	● ▲	23	ASS65R	● ▲	22	ASS93R	●	25
ASS33	● ▲	22	ASS66	● ▲	22	ASS94	●	25
ASS33R	● ▲	22	ASS66R	●	22	ASS94R	●	25
ASS34	●	24	ASS67	● ▲	22	ASS102	●	25
ASS34R	● ▲	24	ASS67R	● ▲	22	ASS102R	●	25
ASS35	● ▲	22	ASS68R	● ▲	22	ASS103	● ▲	25
ASS35R	● ▲	22	ASS69	● ▲	22	ASS103R	●	25
ASS36	● ▲	24	ASS69R	● ▲	22	ASS104	●	25
ASS36R	● ▲	24	ASS73	●	23	ASS104R	●	25
ASS37	● ▲	22	ASS73R	● ▲	23	ASS105	▲	25
ASS37R	● ▲	22	ASS76	●	23	ASS105R	●	25
ASS38	● ▲	23	ASS76R	● ▲	23	ASS106R	● ▲	25
ASS38R	●	23	ASS77	●	23	ASS107	●	24
ASS39	● ▲	24	ASS77R	● ▲	23	ASS107R	●	24
ASS39R	● ▲	24	ASS78	●	23	ASS108	●	24
ASS40	●	23	ASS78R	● ▲	23	ASS109	●	24
ASS40R	●	23	ASS79	● ▲	23	ASS110	●	23
ASS42	●	23	ASS79R	● ▲	23	ASS110R	●	23
ASS42R	●	23	ASS7R	● ▲	22	ASS112	▲	23
ASS44	● ▲ U	22	ASS80	●	24	ASS112R	●	23
ASS44R	● ▲	22	ASS80R	●	24	ASS113	●	23
ASS45	● ▲	24	ASS81	●	24	ASS113R	●	23
ASS45R	●	24	ASS81R	● ▲	24	ASS115	▲	23
ASS47	● ▲	21	ASS82	● ▲	24	ASS115R	●	23

● Brass  
Ottone  
Messing  
Laiton  
Latón  
Latão

▲ Steel  
Acciaio  
Stahl  
Acier  
Acero  
Aço

■ Nickel silver  
Alpacca  
Neusilber  
Maillechort  
Alpaca  
Alpaca

◆ Iron  
Ferro  
Eisen  
Fer  
Hierro  
Ferro

Ⓒ Available in Color  
Disponibile in Color  
Lieferbar in Color  
Disponibile en Color  
Disponibile en Color  
Disponível em Color

U Available in Ultralite  
Disponibile in Ultralite  
Lieferbar in Ultralite  
Disponibile en Ultralite  
Disponibile en Ultralite  
Disponível em Ultralite

Ⓔ Available in Silky  
Disponibile in Silky  
Lieferbar in Silky  
Disponibile en Silky  
Disponibile en Silky  
Disponível em Silky

REF.		PAGE	REF.		PAGE	REF.		PAGE
ASS116	▲	23	ASS140R	●	23	AUC4	●	19
ASS116R	▲	23	ASS141	●	23	AUC5	●	19
ASS118	▲	23	ASS142	●	23	AUC6	●	19
ASS118R	●	23	ASS143	●	21	AUD1	●▲	25
ASS119	▲	23	ASS144	●	21	AUN1	▲	26
ASS119R	●	23	ASS145	●	21	AUS1	●U	26
ASS120	●	22	ASS146	●	21	AV1	▲	26
ASS120R	●	22	ASS147	●	21	AV1R	▲	26
ASS121	●	22	ASS148	●	21	AV2	▲	26
ASS121R	●	22	ASS149	●	21	AVC1	▲	26
ASS123	●	25	ASS14R	●	24	AW1	▲	20
ASS123R	●	25	ASS150	●	21	AW2	▲	20
ASS124	●▲	22	ASS151	●	21	AW22	▲	20
ASS124R	●	22	ASS152	●	21	AW23	▲	20
ASS125	●	24	ASS153	●	21	AW3	●▲	20
ASS125R	●	24	ASS154	●	21	AW4	▲	20
ASS126	▲	23	ASS155	●▲	21	AW5	●▲■	20
ASS126R	●	23	ASS155R	●▲	21	AW6	●▲	20
ASS127	●▲	23	ASS172	●	21	AW7	●▲U	20
ASS127R	●	23	ASS174	●	21	AX2	▲	26
ASS128	●	23	ASS175R	●	21	AX12	●	26-227
ASS128R	●	23	ASS176	●	21	AY1	●▲■	4
ASS129	▲	25	ASS177	●	21	AY1P	●■	4
ASS129R	●	25	ASS178	●■	21	AY2	●■	5
ASS12R	●▲	23	ASS17R	●▲	22	AY2P	●	5
ASS130	▲	23	ASS18	●	24	AY3	●■	5
ASS130R	●	23	ASS180R	●	22	AY10P	●	6
ASS131	●	23	ASS181	●	21	AY11	●	4
ASS131R	●	23	ASS183	●	25	AY12	■	4
ASS132	●▲	25	ASS183R	●	25	AY13	■	5
ASS132R	●	25	ASS186	▲	21	AY14	■	5
ASS133	●	25	ASS187R	●	21	AY15	●	5
ASS133R	●	25	ASS188	▲	21	AY16	■	4
ASS134	●	23	AST1	◆	271	AY17	■	5
ASS134R	●	23	ASU1R	●▲U	13	AY18	■	5
ASS135	●	23	ASU2	▲	13	AY20	■	5
ASS136	●	23	AT1	●▲	25	AY21	■	5
ASS136R	●	23	AT1R	●▲	25	AY23	■	5
ASS137	●▲	21	AT2R	●▲	25	AY24	■	5
ASS138	●	23	ATA1	▲	25	AY25	■	5
ASS138R	●	23	ATA1R	▲	25	AY26	■	5
ASS139R	●	23	AUC1	●U	19	AY27	■	5

● Brass  
Ottone  
Messing  
Laiton  
Latón  
Latão

▲ Steel  
Acciaio  
Stahl  
Acier  
Acero  
Aço

■ Nickel silver  
Alpaca  
Neusilber  
Maillechort  
Alpaca  
Alpaca

◆ Iron  
Ferro  
Eisen  
Fer  
Hierro  
Ferro

Ⓒ Available in Color  
Disponibile in Color  
Lieferbar in Color  
Disponibile en Color  
Disponibile en Color  
Disponível em Color

Ⓒ Available in Ultralite  
Disponibile in Ultralite  
Lieferbar in Ultralite  
Disponibile en Ultralite  
Disponibile en Ultralite  
Disponível em Ultralite

Ⓒ Available in Silky  
Disponibile in Silky  
Lieferbar in Silky  
Disponibile en Silky  
Disponibile en Silky  
Disponível em Silky

REF.		PAGE	REF.		PAGE	REF.		PAGE
AY28	■	6	BAB20	▲	29	BAB30R-9	▲	29
AY29	■	6	BAB21-3	▲	29	BAB31	▲	29
AY30	▲	4	BAB21-4	▲	29	BAB36R	▲	29
AY31	●	5	BAB21-5	▲	29	BAD1	▲	30
AY3P	●	5	BAB25	●▲	28	BAD1R	▲	30
AZ1	▲	26	BAB25R	▲	28	BAE1	●	30-227
AZ2	●▲UⓈ	27	BAB26R-1	●	29	BAE2R	●	30-227
AZ2R	▲U	27	BAB26R-10	●	29	BAE3	●	30-227
AZ2X	▲	27	BAB26R-11	●	29	BAI1	▲■U	31
AZ3	●▲U	26	BAB26R-12	▲	29	BAI2	▲	30
AZ3R	●▲U	26	BAB26R-13	▲	29	BAI23	▲	31
AZ4	●▲	27	BAB26R-14	▲	29	BAI25	▲	31
AZ5	●▲	27	BAB26R-15	▲	29	BAI25R	▲	31
AZ6	●U	27-227	BAB26R-16	▲	29	BAI3	▲	30
AZ6R	●	27-227	BAB26R-17	▲	29	BAI4R	▲	30
AZ7	●	27-227	BAB26R-18	▲	29	BAI5R	▲	30
AZ8	●	27-227	BAB26R-19	▲	29	BAI7	▲	31
AZ9	▲	27	BAB26R-2	●	29	BAL1	▲	28
AZ9R	▲	27	BAB26R-20	▲	29	BAL1R	●▲	28
AZ10	▲Ⓢ	27	BAB26R-21	▲	29	BAL2	▲	28
AZ10R	▲	27	BAB26R-22	▲	29	BAL3	▲	28
AZ11	▲	27	BAB26R-23	▲	29	BAL4	▲	28
AZ1R	●▲	26	BAB26R-3	●	29	BAL5	▲	28
<b>B</b>			BAB26R-4	●	29	BAL6	●	28
BA1	●▲	31	BAB26R-5	●	29	BAL7	●▲	28
BA5	●▲	31	BAB26R-6	●	29	BAR1	▲	30
BA5R	●▲	31	BAB26R-7	●	29	BAR1R	▲	30
BA8	●▲	31	BAB26R-8	●	29	BAS1	●▲	31
BA8R	●▲	31	BAB26R-9	●	29	BAS4R	▲	31
BAB2R	▲	28	BAB27	●	28	BAS5R	▲	31
BAB4R	▲	28	BAB28R	●	28	BAT1P	■	31
BAB5R	●▲	28	BAB29	●	28	BAT2	▲	32
BAB6R	●▲	28	BAB30R-1	▲	29	BC1	▲	30
BAB7R	▲	28	BAB30R-10	▲	29	BC1R	▲	30
BAB13	●▲Ⓢ	28	BAB30R-11	▲	29	BD1	▲	39
BAB13R	●▲	28	BAB30R-2	▲	29	BD10	▲	39
BAB14	▲	28	BAB30R-3	▲	29	BD10R	▲	39
BAB15	▲	29	BAB30R-4	▲	29	BD11	●	39-228
BAB16	▲	29	BAB30R-5	▲	29	BD11X	●	39-228
BAB18R	▲	28	BAB30R-6	▲	29	BD13	●	39-228
BAB19	▲	29	BAB30R-7	▲	29	BD14	●	39-228
			BAB30R-8	▲	29	BD14X	●	39-228

● Brass  
Ottone  
Messing  
Laiton  
Latón  
Latão

▲ Steel  
Acciaio  
Stahl  
Acier  
Acero  
Aço

■ Nickel silver  
Alpacca  
Neusilber  
Maillechort  
Alpaca  
Alpaca

◆ Iron  
Ferro  
Eisen  
Fer  
Hierro  
Ferro

Ⓒ Available in Color  
Disponibile in Color  
Lieferbar in Color  
Disponibile en Color  
Disponibile en Color  
Disponível em Color

Ⓘ Available in Ultralite  
Disponibile in Ultralite  
Lieferbar in Ultralite  
Disponibile en Ultralite  
Disponibile en Ultralite  
Disponível em Ultralite

Ⓢ Available in Silky  
Disponibile in Silky  
Lieferbar in Silky  
Disponibile en Silky  
Disponibile en Silky  
Disponível em Silky

REF.		PAGE	REF.		PAGE	REF.		PAGE
BD16	●	39-228	BES17	▲	33	BK18	▲	34
BD17	▲	39	BES18	● ■	33	BK1R	● ▲ U	34
BD2	▲	39	BEY1R	●	33-227	BK1X	● ▲ U ⊕	34
BD21	●	39-228	BEY2R	●	33-227	BK20	● ■	34
BD22	●	39-228	BG1	● ▲	34	BK21R	▲	34
BD2R	● ▲	39	BHF1T	◆	36	BK22R	▲	34
BD3	● ▲ U	39	BI062	●	33	BK23R	▲	34
BD3R	● ▲ U	39	BI063	● ▲	33	BK26	▲	35
BD4	● ▲	39	BI110	●	33	BK27	▲	34
BD4R	● ▲	39	BIL1T	●	34	BK28	▲ ■	34
BD5	▲	39	BK1	● ▲ U ⊕	34	BK29	● ■	34
BD6	● ▲ ⊕	39	BK100	▲	34	BK2R	● ▲	34
BD6R	● ▲ ⊕	39	BK10-00	■	36	BK30	■	34
BD7	▲	39	BK10-01	■	36	BK31	■	34
BD8	▲	39	BK10-02	■	36	BK3-1	● ▲	34
BD8R	▲	39	BK10-03	■	36	BK3-10	● ▲	34
BD9R	● ▲ U ⊕ ⊕	39	BK10-04	■	36	BK3-11	● ▲	34
BD100	●	39	BK10-05	■	36	BK3-12	● ▲ ⊕	34
BD101	●	39	BK10-06	■	36	BK32	■	34
BD102	●	39	BK10-07	■	36	BK3-2	● ▲	34
BDA10	▲	36	BK10-08	■	36	BK3-3	● ▲ ⊕	34
BE1	● ▲	33	BK10-09	■	36	BK34	■	34
BE1R	●	33	BK10-10	■	36	BK3-4	● ▲ ⊕	34
BE200	● ▲ U ⊕	33	BK10-11	■	36	BK3-5	● ▲	34
BE201	● ▲ U ⊕	33	BK10-12	■	36	BK36	■	34
BE202	● ▲ U ⊕	33	BK10-13	■	36	BK3-6	● ▲	34
BE203	● ▲ U	33	BK10-14	■	36	BK37	■	34
BES2	● ▲ ■	33	BK10-15	■	36	BK3-7	● ▲ ⊕	34
BES3	● ■	33	BK10-16	■	36	BK38	■	34
BES4	● ■	33	BK10-17	■	36	BK3-8	● ▲ ⊕	34
BES5	● ■	33	BK10-18	■	36	BK3-9	● ▲	34
BES6	● ▲ ■	33	BK10-19	■	36	BK4	▲	35
BES7	● ■	33	BK10-20	■	36	BK48R	▲	34
BES8	● ■	33	BK10-21	■	36	BK49R	▲	34
BES9	● ■	33	BK10-22	■	36	BK4R	● ▲	35
BE3	● ▲ U	33	BK10-23	■	36	BK5-1	● ▲	35
BE4R	●	33	BK10-30	■	36	BK5-10	● ▲	35
BES1	● ▲ ■	33	BK11R	▲	35	BK5-11	● ▲	35
BES10	● ■	33	BK13	▲	34	BK5-12	● ▲	35
BES11	● ■	33	BK15	● ▲	34	BK5-13	● ▲	35
BES12	● ■	33	BK16	▲	34	BK5-14	● ▲	35
BES16	▲	33	BK17	▲	34	BK5-15	● ▲	35

● Brass  
Ottone  
Messing  
Laiton  
Latón  
Latão

▲ Steel  
Acciaio  
Stahl  
Acier  
Acero  
Aço

■ Nickel silver  
Alpaca  
Neusilber  
Maillechort  
Alpaca  
Alpaca

◆ Iron  
Ferro  
Eisen  
Fer  
Hierro  
Ferro

⊕ Available in Color  
Disponibile in Color  
Lieferbar in Color  
Disponibile en Color  
Disponibile en Color  
Disponível em Color

U Available in Ultralite  
Disponibile in Ultralite  
Lieferbar in Ultralite  
Disponibile en Ultralite  
Disponibile en Ultralite  
Disponível em Ultralite

⊕ Available in Silky  
Disponibile in Silky  
Lieferbar in Silky  
Disponibile en Silky  
Disponibile en Silky  
Disponível em Silky

REF.		PAGE	REF.		PAGE	REF.		PAGE
BK5-16	● ▲	35	BK6-19	● ▲	35	BLA2	▲	36
BK5-17	●	35	BK6-2	● ▲	35	BLA3	▲	36
BK5-18	● ▲	35	BK6-20	● ▲	35	BLG1	▲	41
BK5-19	● ▲	35	BK6-21	●	35	BLG2	▲	41
BK52	■	34	BK6-22	● ▲	35	BLL1	● ▲	32
BK5-2	● ▲	35	BK6-23	● ▲	35	BLL2	● ▲	32
BK5-20	● ▲	35	BK6-24	● ▲	35	BLL3	● ▲	32
BK5-21	● ▲	35	BK6-25	● ▲	35	BLL4	● ▲	32
BK5-22	● ▲	35	BK6-26	●	35	BLL5	● ▲	32
BK5-23	● ▲	35	BK6-27	● ▲	35	BLT1R	▲	179
BK5-24	● ▲	35	BK6-28	● ▲	35	BLV1R	●	32
BK5-25	● ▲	35	BK6-29	● ▲	35	BLV2R	●	32
BK5-26	● ▲	35	BK6-3	● ▲	35	BLV3	●	32
BK5-27	● ▲	35	BK6-30	● ▲	35	BM1	● ■	30
BK5-28	● ▲	35	BK6-31	● ▲	35	BM2	●	30
BK5-29	● ▲	35	BK6-32	● ▲	35	BMB1	● ▲	36
BK53	■	34	BK6-33	●	35	BMB1R	●	36
BK5-3	● ▲	35	BK6-34	●	35	BMB2	● ▲	36
BK5-30	● ▲	35	BK6-35	●	35	BMB3	● ▲	36
BK5-31	● ▲	35	BK6-4	● ▲	35	BMB3R	●	36
BK5-32	● ▲	35	BK6-5	● ▲	35	BMB4	● ▲	36
BK5-33	● ▲	35	BK6-6	● ▲	35	BMB4R	●	36
BK5-34	●	35	BK6-7	● ▲	35	BMB5	● ▲	36
BK5-35	● ▲	35	BK6-8	● ▲	35	BN1	●	32
BK5-4	● ▲	35	BK6-9	● ▲	35	BN1R	●	32
BK5-5	● ▲	35	BK7R-1	● ▲	34	BN2	●	32
BK5-6	● ▲	35	BK7R-10	●	34	BN2R	●	32
BK5-7	● ▲	35	BK7R-2	●	34	BNK1	●	36-227
BK5-8	● ▲	35	BK7R-3	● ▲	34	BNL1R	▲	30
BK5-9	● ▲	35	BK7R-4	●	34	BO2	● ▲	37
BK60	▲	34	BK7R-5	● ▲	34	BO2R	● ▲	37
BK61	●	34-227	BK7R-6	● ▲	34	BO6	▲	37
BK6-1	● ▲	35	BK7R-7	● ▲	34	BO6R	▲	37
BK6-10	●	35	BK7R-8	● ▲	34	BOR1	●	37
BK6-11	● ▲	35	BK7R-9	● ▲	34	BOR1R	●	37
BK6-12	● ▲	35	BK8	●	35	BOS1	▲	37
BK6-13	●	35	BK8R	●	35	BOS3	● ▲	37
BK6-14	● ▲	35	BK99-03	■	34	BR1	●	38
BK6-15	● ▲	35	BK99-08	■	34	BRA1R	●	37
BK6-16	● ▲	35	BL1	▲	36	BRA2R	● U	37
BK6-17	● ▲	35	BL1R	● ▲	36	BRA3R	●	37
BK6-18	●	35	BLA1	▲	36	BRA5	● U	38

● Brass  
Ottone  
Messing  
Laiton  
Latón  
Latão

▲ Steel  
Acciaio  
Stahl  
Acier  
Acero  
Aço

■ Nickel silver  
Alpacca  
Neusilber  
Maillechort  
Alpaca  
Alpaca

◆ Iron  
Ferro  
Eisen  
Fer  
Hierro  
Ferro

Ⓒ Available in Color  
Disponibile in Color  
Lieferbar in Color  
Disponibile en Color  
Disponibile en Color  
Disponível em Color

U Available in Ultralite  
Disponibile in Ultralite  
Lieferbar in Ultralite  
Disponibile en Ultralite  
Disponibile en Ultralite  
Disponível em Ultralite

Ⓔ Available in Silky  
Disponibile in Silky  
Lieferbar in Silky  
Disponibile en Silky  
Disponibile en Silky  
Disponível em Silky

REF.		PAGE	REF.		PAGE	REF.		PAGE
BRA6R	● U	38	BUR6	▲	41-135	BUS1	● ▲	44
BRA7R	● U	37	BUR7	▲	41	BUT1R	■	41-228
BRA8R	● U	38	BUR8	● ▲	41	BUT2R	▲	41
BRA9R	●	37	BUR9	▲	42	BUT3R	▲	41
BRA10R	● U	37	BUR10R	▲	42	BUT4R	▲	41
BRA11R	● U	38	BUR11	● ▲	42	BVA1	● ▲ U	44
BRA15R	●	38	BUR12	▲	42	BVA1R	▲	44
BRA16R	●	37	BUR13	▲	43	BVA3	● ▲	44
BRM1	● ▲	40	BUR14R	▲	43	BVA4	▲	44
BRM1R	●	40	BUR15	▲	42	BY1	▲	37
BRS1R	●	40-228	BUR16	▲	42	BZ2	▲	154
BRS2	▲	40	BUR17R	▲	42	BZ2R	▲	154
BRS3R	●	40-228	BUR18	▲	43	BZ3	●	154-243
BRT1	● ▲	32	BUR19	▲	42	<b>C</b>		
BRT2	▲	33	BUR20	▲	43	C1	● ▲	63
BRT3	▲	33	BUR20R	▲	43	C1R	● ▲	63
BRT4	▲	33	BUR21	● ▲	43	C303	▲	54
BS1	● ▲	40	BUR21R	▲	43	C555	● ▲	54
BS2	▲ U	40	BUR22	▲	42	CA1	● ▲	58
BS3	● ▲	40	BUR22R	▲	42	CA2	● ▲ U	58-222
BS4R	▲	40	BUR23	● ▲	42	CA2R	● ▲ U	58-222
BS5	▲	40	BUR23R	▲	42	CA3	▲	58
BS5R	▲ U	40	BUR24R	▲	43	CA4	▲	58
BS6R	▲	40	BUR25	▲	42	CA5	▲	58
BS7	▲	40	BUR26	▲	43	CA6	▲	221
BS7R	▲	40	BUR27	●	44-228	CA7	● ▲	222
BSI1	● ▲	31	BUR28R	▲	43	CA8	● ▲ U	221
BSI1R	● ▲	31	BUR29	▲	42	CA9	● ▲	119
BSI2	● ▲	31	BUR31	▲	43	CA10	▲	222
BSI2R	● ▲	31	BUR31R	▲	43	CA10R	▲	222
BSI4	● ▲	31	BUR32	●	43	CA11	▲ U	222
BSI4R	● ▲	31	BUR33	●	44-228	CA11R	▲	222
BU1	● ▲	41	BUR34R	● ▲	43	CA12	▲	221
BU1R	● ▲	41	BUR35	▲	42	CA13	▲	221
BUR1	▲	41	BUR36	▲	42	CA14	▲	221
BUR1R	▲	41	BUR38	▲	43	CA15	▲ U	58-222
BUR2	▲ U	41-136	BUR55R	▲	44	CAB1	● ▲	44
BUR2R	▲	41-136	BUR56	▲	44	CAB2R	● ▲	44
BUR3	▲	42	BUR57R	▲	44	CAF1	● ▲	44
BUR3R	▲	42	BUR60R	▲	43	CAF1R	● ▲	44
BUR4	▲	42	BUR61R	▲	43	CAF2	● ▲	44
BUR5	▲	42	BUR62	▲	42			

● Brass  
Ottone  
Messing  
Laiton  
Latón  
Latão

▲ Steel  
Acciaio  
Stahl  
Acier  
Acero  
Aço

■ Nickel silver  
Alpaca  
Neusilber  
Maillechort  
Alpaca  
Alpaca

◆ Iron  
Ferro  
Eisen  
Fer  
Hierro  
Ferro

Ⓒ Available in Color  
Disponibile in Color  
Lieferbar in Color  
Disponibile en Color  
Disponibile en Color  
Disponível em Color

Ⓒ Available in Ultralite  
Disponibile in Ultralite  
Lieferbar in Ultralite  
Disponibile en Ultralite  
Disponibile en Ultralite  
Disponível em Ultralite

Ⓒ Available in Silky  
Disponibile in Silky  
Lieferbar in Silky  
Disponibile en Silky  
Disponibile en Silky  
Disponível em Silky

REF.		PAGE	REF.		PAGE	REF.		PAGE
CAF2R	● ▲	44	CB24R	● ▲ ■ U	62	CB101R	▲	60
CAR1	● ▲	45	CB25R	● ▲	62	CB102R	●	62
CAX1R	● ▲	45	CB26R	●	62	CB103R	▲	60
CAX2R	● ▲	45	CB27R	●	62	CB104R	●	61
CB1	● ▲ U	59-146	CB28R	● ▲	61	CB105R	●	60
CB1R	▲	59-146	CB29	● ▲	61	CB106	▲	61
CB2	● ▲	59	CB29R	● ▲	61	CC1	● ▲ U C	63
CB2R	● ▲	59	CB30	● ▲ U	61	CC1R	● U	63
CB3	● ▲	59-146	CB30R	● ▲	61	CC2	● ▲ U	62
CB3-OR	U	59	CB31	▲ ■	61	CC2R	● ▲ U	62
CB3R	● ▲ U	59	CB32	● ▲	60	CC3	● U	62
CB4	● ▲	60	CB33R	● ▲	62	CC3R	● ▲ U	62
CB4-OR	U	60	CB34R	● ▲ U	62	CC4	●	62
CB4R	● ▲	60	CB37	●	61	CC5	●	62
CB5	● ▲ U	60	CB38	● ▲	61	CC6R	● U	62
CB5R	● ▲	60	CB38R	● ▲	61	CC7	●	62
CB6	● ▲ U C S	60-125	CB39R	▲	61	CC7R	● ▲	62
CB6-OR	U	60	CB40R	●	62	CC8	●	63
CB6R	▲ U	60	CB41R	● ▲	62	CCC1	●	46
CB7	● ▲ C	60	CB42	▲	60	CCC1R	●	46
CB7R	● ▲	60	CB43R	● ▲	60	CDP1R	▲	46
CB8	● ▲ C	60	CB44R	● U	62	CE1	● ▲ U C	47
CB9	● ▲ C	60	CB70	●	60	CE10	● ▲	47
CB9-OR	U	60	CB78R	● ▲	60	CE11	● ▲	47
CB10	● ▲ C	62	CB79	●	60	CE114	●	48
CB11	● ▲ C	61	CB80	● ▲	59	CE11R	▲	47
CB11R	● U	61	CB81	● ▲	60	CE12	● ▲	48
CB12	● ▲ C	61	CB82	●	61	CE13	▲	47
CB12R	● ▲	61	CB83	● ▲	61	CE13R	● ▲	47
CB13	● ▲ C	62	CB84	●	61	CE14-15	● ▲	49
CB13R	● ▲	62	CB85	● ▲ G	60	CE14-16	● ▲	49
CB14	● ▲ C	62	CB86	●	61	CE14-17	● ▲	49
CB14R	● ▲	62	CB87	●	61-230	CE14-18	● ▲	49
CB15	● ▲ C	60	CB88R	●	61	CE14-25	● ▲	49
CB16	▲ U C	60	CB89R	●	61	CE14-26	● ▲	49
CB17	▲ U C	60	CB90R	● ▲	61	CE14-27	● ▲	49
CB18	● ▲	61	CB95R	●	60	CE14-28	● ▲	49
CB19	▲	60	CB96R	● ▲	60	CE14-35	● ▲	49
CB20	● ▲	62	CB97	● C S	61-230	CE14-36	● ▲	49
CB21	● ▲ U	61	CB98	●	61-230	CE14-37	● ▲	49
CB22R	● ▲ U	62	CB99R	▲	60	CE14-38	●	49
CB23R	● ▲ ■ U	62	CB100R	▲	60	CE14-45	●	49

● Brass  
Ottone  
Messing  
Laiton  
Latón  
Latão

▲ Steel  
Acciaio  
Stahl  
Acier  
Acero  
Aço

■ Nickel silver  
Alpacca  
Neusilber  
Maillechort  
Alpaca  
Alpaca

◆ Iron  
Ferro  
Eisen  
Fer  
Hierro  
Ferro

C Available in Color  
Disponibile in Color  
Lieferbar in Color  
Disponibile en Color  
Disponibile en Color  
Disponível em Color

U Available in Ultralite  
Disponibile in Ultralite  
Lieferbar in Ultralite  
Disponibile en Ultralite  
Disponibile en Ultralite  
Disponível em Ultralite

S Available in Silky  
Disponibile in Silky  
Lieferbar in Silky  
Disponibile en Silky  
Disponibile en Silky  
Disponível em Silky

REF.		PAGE	REF.		PAGE	REF.		PAGE
CE14-46	●	49	CE129-37	●	50	CE129-79	●	50
CE14-47	● ▲	49	CE129-38	●	50	CE129-80	●	50
CE14-48	● ▲	49	CE129-39	●	50	CE129-81	●	50
CE15	● ▲	49	CE129-40	●	50	CE129-82	●	50
CE16	●	49	CE129-41	●	50	CE129-83	●	50
CE127	● ▲	48	CE129-42	●	50	CE129-84	●	50
CE129-1	●	50	CE129-43	●	50	CE129-85	●	50
CE129-2	●	50	CE129-44	●	50	CE129-86	●	50
CE129-3	●	50	CE129-45	●	50	CE129-87	●	50
CE129-4	●	50	CE129-46	●	50	CE129-88	●	50
CE129-5	●	50	CE129-47	●	50	CE129-89	●	50
CE129-6	●	50	CE129-48	●	50	CE129-90	●	50
CE129-7	●	50	CE129-49	●	50	CE130-1	●	51
CE129-8	●	50	CE129-50	●	50	CE130-2	●	51
CE129-9	●	50	CE129-51	●	50	CE130-3	●	51
CE129-10	●	50	CE129-52	●	50	CE130-4	●	51
CE129-11	●	50	CE129-53	●	50	CE130-5	●	51
CE129-12	●	50	CE129-54	●	50	CE130-6	●	51
CE129-13	●	50	CE129-55	●	50	CE130-7	●	51
CE129-14	●	50	CE129-56	●	50	CE130-8	●	51
CE129-15	●	50	CE129-57	●	50	CE130-9	●	51
CE129-16	●	50	CE129-58	●	50	CE130-10	●	51
CE129-17	●	50	CE129-59	●	50	CE130-11	●	51
CE129-18	●	50	CE129-60	●	50	CE130-12	●	51
CE129-19	●	50	CE129-61	●	50	CE130-13	●	51
CE129-20	●	50	CE129-62	●	50	CE130-14	●	51
CE129-21	●	50	CE129-63	●	50	CE130-15	●	51
CE129-22	●	50	CE129-64	●	50	CE130-16	●	51
CE129-23	●	50	CE129-65	●	50	CE130-17	●	51
CE129-24	●	50	CE129-66	●	50	CE130-18	●	51
CE129-25	●	50	CE129-67	●	50	CE130-19	●	51
CE129-26	●	50	CE129-68	●	50	CE130-20	●	51
CE129-27	●	50	CE129-69	●	50	CE130-21	●	51
CE129-28	●	50	CE129-70	●	50	CE130-22	●	51
CE129-29	●	50	CE129-71	●	50	CE130-23	●	51
CE129-30	●	50	CE129-72	●	50	CE130-24	●	51
CE129-31	●	50	CE129-73	●	50	CE130-25	●	51
CE129-32	●	50	CE129-74	●	50	CE130-26	●	51
CE129-33	●	50	CE129-75	●	50	CE130-27	●	51
CE129-34	●	50	CE129-76	●	50	CE130-28	●	51
CE129-35	●	50	CE129-77	●	50	CE130-29	●	51
CE129-36	●	50	CE129-78	●	50	CE130-30	●	51

● Brass  
Ottone  
Messing  
Laiton  
Latón  
Latão

▲ Steel  
Acciaio  
Stahl  
Acier  
Acero  
Aço

■ Nickel silver  
Alpaca  
Neusilber  
Maillechort  
Alpaca  
Alpaca

◆ Iron  
Ferro  
Eisen  
Fer  
Hierro  
Ferro

Ⓒ Available in Color  
Disponibile in Color  
Lieferbar in Color  
Disponibile en Color  
Disponibile en Color  
Disponível em Color

Ⓘ Available in Ultralite  
Disponibile in Ultralite  
Lieferbar in Ultralite  
Disponibile en Ultralite  
Disponibile en Ultralite  
Disponível em Ultralite

Ⓔ Available in Silky  
Disponibile in Silky  
Lieferbar in Silky  
Disponibile en Silky  
Disponibile en Silky  
Disponível em Silky



REF.		PAGE	REF.		PAGE	REF.		PAGE
CE130-31	●	51	CE17X31	● ▲ ■	49	CE28	● ▲	48
CE130-32	●	51	CE17X32	● ▲ ■	49	CE29R	● ▲	47
CE130-33	●	51	CE17X33	● ▲ ■	49	CE2R	● ▲	47
CE130-34	●	51	CE17X34	● ▲ ■	49	CE2X	● ▲ U G S	47
CE130-35	●	51	CE17X35	● ▲ ■	49	CE3	● ▲ U	47
CE131	●	49-228	CE17X36	● ▲ ■	49	CE30	● ▲	47
CE147	▲	47	CE17X37	● ▲ ■	49	CE30R	● ▲	47
CE149	▲	49	CE17X38	● ▲ ■	49	CE31	● ▲	48
CE150	●	48	CE17X39	● ▲ ■	49	CE32R	● ▲	48
CE153R	▲	47-48	CE17X40	● ▲ ■	49	CE33	● ▲	47
CE154	▲	48	CE17X41	● ▲ ■	49	CE34	▲	47
CE155	▲	48	CE17X42	● ▲ ■	49	CE35	▲	47
CE158	●	49	CE17XPS	● ▲	48	CE36	▲	47
CE17W23	● ▲ ■	49	CE18	▲	47	CE38W23	▲	50
CE17W24	● ▲ ■	49	CE18R	● ▲	47	CE38W24	▲	50
CE17W25	● ▲ ■	49	CE19	● ▲	47	CE38W25	▲	50
CE17W26	● ▲ ■	49	CE19R	● ▲	47	CE38W26	▲	50
CE17W27	● ▲ ■	49	CE1R	● ▲	47	CE38W27	▲	50
CE17W28	● ▲ ■	49	CE2	● ▲ U G	47	CE38W28	▲	50
CE17W29	● ▲ ■	49	CE20	● ▲ U S	48	CE38W29	▲	50
CE17W30	● ▲ ■	49	CE21R	● ▲	47	CE38W30	▲	50
CE17W31	● ▲ ■	49	CE22-15	●	49	CE38W31	▲	50
CE17W32	● ▲ ■	49	CE22-16	● ▲	49	CE38W32	▲	50
CE17W33	● ▲ ■	49	CE22-17	●	49	CE38W33	▲	50
CE17W34	● ▲ ■	49	CE22-18	●	49	CE38W34	▲	50
CE17W35	● ▲ ■	49	CE22-25	●	49	CE38W35	▲	50
CE17W36	● ▲ ■	49	CE22-26	●	49	CE38W36	▲	50
CE17W37	● ▲ ■	49	CE22-27	●	49	CE38W37	▲	50
CE17W38	● ▲ ■	49	CE22-28	● ▲	49	CE38W38	▲	50
CE17W39	● ▲ ■	49	CE22-35	●	49	CE38W39	▲	50
CE17W40	● ▲ ■	49	CE22-36	●	49	CE38W40	▲	50
CE17W41	● ▲ ■	49	CE22-37	●	49	CE38W41	▲	50
CE17W42	● ▲ ■	49	CE22-38	●	49	CE38W42	▲	50
CE17WPS	● ▲	48	CE22-45	● ▲	49	CE39	● ▲	49
CE17X23	● ▲ ■	49	CE22-46	●	49	CE3R	● ▲	47
CE17X24	● ▲ ■	49	CE22-47	●	49	CE4	● ▲	47
CE17X25	● ▲ ■	49	CE22-48	●	49	CE40	▲	48
CE17X26	● ▲ ■	49	CE23R	● ▲	48	CE41	● ▲ U	48
CE17X27	● ▲ ■	49	CE24R	● ▲	48	CE41XL	▲	48
CE17X28	● ▲ ■	49	CE25R	● ▲	48	CE41X-OV	▲	48
CE17X29	● ▲ ■	49	CE26R	● ▲	48	CE4R	● ▲	47
CE17X30	● ▲ ■	49	CE27	● ▲	48	CE5	● ▲	47

● Brass  
Ottone  
Messing  
Laiton  
Latón  
Latão

▲ Steel  
Acciaio  
Stahl  
Acier  
Acero  
Aço

■ Nickel silver  
Alpacca  
Neusilber  
Maillechort  
Alpaca  
Alpaca

◆ Iron  
Ferro  
Eisen  
Fer  
Hierro  
Ferro

Ⓒ Available in Color  
Disponibile in Color  
Lieferbar in Color  
Disponibile en Color  
Disponibile en Color  
Disponível em Color

Ⓘ Available in Ultralite  
Disponibile in Ultralite  
Lieferbar in Ultralite  
Disponibile en Ultralite  
Disponibile en Ultralite  
Disponível em Ultralite

Ⓢ Available in Silky  
Disponibile in Silky  
Lieferbar in Silky  
Disponibile en Silky  
Disponibile en Silky  
Disponível em Silky

REF.		PAGE	REF.		PAGE	REF.		PAGE
CE6	● ▲	47	CHS1	● ▲	52	CLU1	●	59
CE6R	▲	47	CHU5	● ▲ ■	52	CLU1R	●	59
CE7	● ▲	47	CHU6	▲	52	CLU2	●	59
CE7R	● ▲	47	CHU7	■	26	CLU2R	●	59
CE8	● ▲	47	CHV1	▲	51	CLU3	●	59
CE9	● ▲	47	CHV1R	● ▲	51	CLU3R	●	59
CEE1	▲	46	CIA1	● U	52	CLU4	●	59
CEN1	● ▲ U	46	CIL1	● ▲	53	CLU4R	●	59
CEN1R	● ▲ U G	46	CIL1R	●	53	CLU5	●	59
CEN2	▲	46	CIL2	● U	53	CLU5R	●	59
CEN2R	▲	46	CIL2R	● ▲	53	CM1	● ▲	46
CEN3	▲	46	CIL3	●	53	CM1R	● ▲	46
CEN4R	● ▲	46	CIL4	● ▲	53	CM2	● ▲	46-95
CEN5T	●	46	CIL5	●	53	CM2R	● ▲	46-95
CF1	▲	53	CIL6	● ▲ U	53	CM3	● ▲	46
CF1R	● ▲	53	CIL7	●	53	CM3R	● ▲	46
CF2	● ▲	53	CIS1	● ▲	45	CM4	● ▲	46
CF2R	● ▲	53	CIS11	● ▲	45	CM4R	● ▲	46
CF3	▲	53	CIS12	●	45-228	CNP1R	●	59
CF4	▲	53	CIS12X	●	45-228	CO1	● ▲	63
CH1	● ▲	51	CIS2	● ▲ U	45	CO1R	● ▲	63
CH10	●	52	CIS3	● ▲	45	COL1	● ▲	59
CH11	● ▲	52	CIS4	● ▲	45	COL2	● ▲	59
CH12	● ▲	52	CIS4R	●	45	COL3	● ▲	59
CH13	● ▲	52	CIS5	● ▲ U	45	COL4	● ▲	59
CH14	● ▲	52	CIS5R	●	45	COR1	● ▲	63
CH15	● ▲	51	CIS6	▲	45	COR2	●	63
CH16T	●	52	CIS6R	●	45	COR2R	●	63
CH17T	●	52	CIS7	●	45	CR2R	▲	59
CH18	● ▲	52	CIS8	●	45	CR5R	▲	59
CH19	● ▲	52	CIS9	●	45-228	CRE401	◆	270
CH2	● ▲	51	CK1	● ▲	51	CRE402	◆	270
CH24R	●	52	CKM1	● ▲	171	CRE403	◆	270
CH27	●	52	CLF2	▲	45	CRE404	◆	270
CH3	● ▲	51	CLI1	●	53	CRE405	◆	270
CH4	● ▲	51	CLK1	▲	51	CRE406	◆	270
CH5	● ▲	51	CLL1	● ▲	59	CRL1	●	53-228
CH6	●	51	CLS1	● ▲	53	CS10	● ▲	57
CH7	●	51	CLS2	● ▲	53	CS1003	◆	269
CH7R	● ▲	51	CLS220	●	53	CS105	●	55
CH8	● ▲	51	CLS242	● ▲	53	CS10R	● ▲	57
CH9T	●	52	CLS3	● ▲	53	CS11	● ▲	57

● Brass  
Ottone  
Messing  
Laiton  
Latón  
Latão

▲ Steel  
Acciaio  
Stahl  
Acier  
Acero  
Aço

■ Nickel silver  
Alpaca  
Neusilber  
Maillechort  
Alpaca  
Alpaca

◆ Iron  
Ferro  
Eisen  
Fer  
Hierro  
Ferro

Ⓒ Available in Color  
Disponibile in Color  
Lieferbar in Color  
Disponibile en Color  
Disponibile en Color  
Disponível em Color

Ⓒ Available in Ultralite  
Disponibile in Ultralite  
Lieferbar in Ultralite  
Disponibile en Ultralite  
Disponibile en Ultralite  
Disponível em Ultralite

Ⓒ Available in Silky  
Disponibile in Silky  
Lieferbar in Silky  
Disponibile en Silky  
Disponibile en Silky  
Disponível em Silky

Articles and materials general index / Índice Generale articoli e materiali / Allgemeines Artikel- und Materialverzeichnis / Table des matières des articles et des matériaux / Índice general de los artículos y de los materiales / Índice geral dos artigos e dos materiais

REF.		PAGE	REF.		PAGE	REF.		PAGE
CS115	● C	56-229	CS170	●	56	CS38R	● ▲	55
CS116AP	●	57-230	CS17R	● ▲	55	CS4	● ▲	56
CS116P	●	56-230	CS18	● ▲	55	CS41	●	55
CS119	● ▲ U S	56	CS18R	● ▲	55	CS42	●	55
CS119R	● ▲	56	CS19	▲	58	CS43	●	55
CS12	● ▲	14-57	CS19R	● ▲	58	CS44	● ▲	55
CS120	● ▲	56	CS20	● ▲	58	CS44R	●	55
CS120R	●	56	CS204	● ▲ U C S	55	CS45	● ▲	58
CS121	●	56	CS205	● ▲ U	55	CS45R	● ▲	58
CS12R	●	14-57	CS206	● ▲ U C S	55	CS46	● ▲	55
CS13	● ▲	55	CS207	● ▲ U	55	CS46R	● ▲	55
CS138	●	55	CS20R	● ▲	58	CS47	●	55
CS139	●	56-229	CS21	● ▲	57	CS47R	●	55
CS139AP	●	57-230	CS21R	●	57	CS48	● ▲ U	56-229
CS139P	●	56-230	CS22	●	57	CS49	● ▲	55
CS13R	▲	55	CS22R	●	57	CS4R	●	56
CS13X	▲	56	CS23	● ▲	40-58	CS5	● ▲	57
CS14	▲	55	CS23R	● ▲	40-58	CS50	● ▲	55
CS140	●	56-229	CS24	● ▲	55	CS500	● ▲	55
CS141	●	56-229	CS24R	●	55	CS500R	●	55
CS142	●	55	CS25	●	55	CS501	● ▲ U	55
CS143	●	55	CS25R	●	55	CS501R	● ▲ U	55
CS144	●	56-229	CS26	● ▲	40-58	CS52X	●	56
CS145	●	56-229	CS26R	▲	40-58	CS5R	●	57
CS146	● C	56-229	CS27	● ▲	58	CS6	● ▲ U	57
CS147	▲	55	CS27R	● ▲	58	CS61	● ▲	56
CS14R	●	55	CS28	● ▲	58-215	CS62	● C S	56-229
CS15	● ▲	55	CS28R	● ▲	58-215	CS62AP	●	57-230
CS152	● ▲	56	CS30	▲	55	CS62P	●	56-230
CS154AP	●	57-230	CS30R	●	55	CS66	●	56
CS155AP	●	57-230	CS31	●	55	CS67	●	55
CS156AP	●	57-230	CS31R	● ▲ U	55	CS68	●	55
CS157AP	●	57-230	CS32	● ▲	40-58	CS6R	● ▲	57
CS158AP	●	57-230	CS32R	● ▲	40-58	CS7	● ▲ U C S	57
CS159AP	●	57-230	CS33	● ▲	40-58	CS70	● S	56-229
CS15R	▲	55	CS33R	▲	40-58	CS70AP	●	57-230
CS16	● ▲	55	CS34	● ▲	55	CS70P	●	56-230
CS162	▲	55	CS34R	● ▲	55	CS7R	● ▲ U	57
CS163X	●	56	CS36	● ▲	55	CS8	● ▲	57
CS168	●	56	CS37	● ▲	55	CS85	● ▲	55
CS16R	● ▲	55	CS37R	● ▲	55	CS88	● ▲	55
CS17	● ▲ U	55	CS38	● ▲	55	CS8R	● ▲	57

● Brass  
Ottone  
Messing  
Laiton  
Latón  
Latão

▲ Steel  
Acciaio  
Stahl  
Acier  
Acero  
Aço

■ Nickel silver  
Alpacca  
Neusilber  
Maillechort  
Alpaca  
Alpaca

◆ Iron  
Ferro  
Eisen  
Fer  
Hierro  
Ferro

C Available in Color  
Disponibile in Color  
Lieferbar in Color  
Disponibile en Color  
Disponibile en Color  
Disponível em Color

U Available in Ultralite  
Disponibile in Ultralite  
Lieferbar in Ultralite  
Disponibile en Ultralite  
Disponibile en Ultralite  
Disponível em Ultralite

S Available in Silky  
Disponibile in Silky  
Lieferbar in Silky  
Disponibile en Silky  
Disponibile en Silky  
Disponível em Silky

REF.		PAGE	REF.		PAGE	REF.		PAGE
CS9	●	57	DB10R	▲	68	DB3	▲	68
CS9R	● ▲	57	DB11	● ▲	68	DB30	▲	68
CT1	● ▲ U	63	DB11R	● ▲	68	DB30R	▲	68
CT1R	●	63	DB12	▲	68	DB31	▲	68
CT2	● ▲	63	DB12R	▲	68	DB31R	▲	68
CT2R	● ▲	63	DB13	● ▲	68	DB32	● ▲	68
CU401	◆	269	DB13R	● ▲	68	DB32R	● ▲	68
CU402	◆	269	DB14	● ▲	68	DB33	● ▲	68
CU403	◆	269	DB14R	● ▲	68	DB33R	▲	68
CU404	◆	269	DB15	● ▲	68	DB34	● ▲	68
CU405	◆	269	DB15R	▲	68	DB34R	▲	68
CU406	◆	269	DB16	▲	68	DB35	▲	68
CU407	◆	269	DB16R	▲	68	DB35R	● ▲	68
CU408	◆	269	DB17	● ▲	68	DB36	▲	68
CU409	◆	269	DB17R	● ▲	68	DB36R	▲	68
CU410	◆	269	DB18	● ▲	68	DB37	▲	68
CU411	◆	269	DB18R	● ▲	68	DB37R	▲	68
CU412	◆	270	DB19	▲	68	DB38	▲	68
CU413	◆	270	DB19R	▲	68	DB38R	▲	68
CV1	●	45	DB1R	▲	68	DB39	▲	68
CV2	● ▲	45	DB2	▲	68	DB39R	▲	68
CV3	● ▲	45	DB20	● ▲	68	DB3R	● ▲	68
CVL1	▲ U	63	DB20R	▲	68	DB4	▲	68
CVL1R	▲ U	63	DB21	▲	68	DB40	▲	68
CVL2	● ▲ U	63	DB21R	● ▲	68	DB40R	▲	68
CVL2R	▲ U	63	DB22	▲	68	DB41	▲	68
CVL3	● ▲ U S	63	DB22R	▲	68	DB41R	● ▲	68
CVL3R	● ▲ U S	63	DB23	▲	68	DB42	▲	68
CVL4	▲	63	DB23R	▲	68	DB42R	▲	68
CVL5R	●	63-230	DB24	● ▲	68	DB43	▲	68
CW1	● ▲	63	DB24R	● ▲	68	DB43R	▲	68
CX7	◆	269	DB25	▲	68	DB44	▲	68
CYS1	▲ U S	46	DB25R	▲	68	DB44R	▲	68
CYS1R	▲	46	DB26	● ▲	68	DB45	▲	68
CYS2	●	46-228	DB26R	● ▲	68	DB45R	● ▲	68
<b>D</b>			DB27	● ▲	68	DB46	▲	68
DAL1	●	64	DB27R	▲	68	DB46R	▲	68
DAL2	● ▲	64	DB28	▲	68	DB47	● ▲	68
DAL2R	● ▲	64	DB28R	▲	68	DB47R	● ▲	68
DB1	▲	68	DB29	▲	68	DB48	▲	68
DB10	● ▲	68	DB29R	▲	68	DB48R	● ▲	68
			DB2R	▲	68	DB49	● ▲	68

● Brass  
Ottone  
Messing  
Laiton  
Latón  
Latão

▲ Steel  
Acciaio  
Stahl  
Acier  
Acero  
Aço

■ Nickel silver  
Alpaca  
Neusilber  
Maillechort  
Alpaca  
Alpaca

◆ Iron  
Ferro  
Eisen  
Fer  
Hierro  
Ferro

Ⓒ Available in Color  
Disponibile in Color  
Lieferbar in Color  
Disponibile en Color  
Disponibile en Color  
Disponível em Color

Ⓒ Available in Ultralite  
Disponibile in Ultralite  
Lieferbar in Ultralite  
Disponibile en Ultralite  
Disponibile en Ultralite  
Disponível em Ultralite

Ⓒ Available in Silky  
Disponibile in Silky  
Lieferbar in Silky  
Disponibile en Silky  
Disponibile en Silky  
Disponível em Silky

REF.		PAGE	REF.		PAGE	REF.		PAGE
DB49R	▲	68	DD8	●	64	DM114	●▲	70
DB4R	●▲	68	DEA2	▲	64	DM115	▲	72
DB5	▲	68	DF3	▲	64	DM115R	●	72
DB50	▲	68	DF3R	▲	64	DM116	▲	70
DB50R	▲	68	DF4R	●	64-230	DM118	●	71-231
DB51	●▲	68	DFE1RP	■	65-231	DM119	●▲U S	70
DB51R	▲	68	DFE2P	●	65-231	DM120	●■	71-231
DB53	▲	68	DFE3RAP	●	65-231	DM12-00	●	72
DB53R	▲	68	DIR1R	●	65-231	DM12-1	●▲	72
DB54	▲	68	DK1	●	65-231	DM12-10	●▲	72
DB54R	▲	68	DK3	●	65-231	DM12-11	●▲	72
DB55	▲	68	DK4	●▲	65	DM12-12	●▲	72
DB55R	▲	68	DK5	●▲	65	DM12-13	●▲	72
DB56	●▲	68	DK6	●■	65-231	DM12-14	●▲	72
DB56R	●▲	68	DK6X	●	65-231	DM12-15	●	72
DB57	●▲	68	DK7	●	65-231	DM12-16	●	72
DB57R	●▲	68	DK8R	▲	65	DM12-17	●	72
DB58	▲	68	DK9R	▲	65	DM12-18	●	72
DB58R	▲	68	DL1R	▲	67-121	DM12-19	●▲	72
DB59	▲	68	DL2	●▲	67-121	DM122	■	71-231
DB59R	▲	68	DL3	●▲	67-121	DM12-2	●▲	72
DB5R	▲	68	DLC1	●	65-231	DM12-20	●	72
DB6	●▲C	68	DLC1R	●	65-231	DM12-21	●▲	72
DB60	▲	67	DLC2R	●	65-231	DM12-22	●▲	72
DB6R	▲C	68	DLC3	●	65-231	DM12-23	●	72
DB7	●▲	68	DM10	▲U	68	DM12-24	●	72
DB7R	●▲	68	DM101	●▲	69	DM12-25	●▲	72
DB8	●▲	68	DM102	▲	69	DM12-26	●	72
DB8R	●▲	68	DM103	●▲	70	DM12-27	●	72
DB9	●▲	68	DM104R	●▲	69	DM12-28	●	72
DB9R	▲	68	DM105R	●▲	70	DM12-29	●▲	72
DBX1R	●	67	DM106	●▲	69	DM12-3	●▲	72
DC1	●	64	DM108	●▲	73	DM12-30	●	72
DCR1	●▲U	75	DM108R	●	73	DM123-1	●	69
DCR2	▲U	75	DM109	●	73	DM12-31	●	72
DD1	▲	64	DM109R	▲	73	DM123-10	●	69
DD2	▲	64	DM10R	●▲	68	DM123-2	●	69
DD3	▲	64	DM11	●▲	69	DM12-32	●	72
DD4	▲	64	DM110	●▲	69	DM123-3	●	69
DD5	▲	64	DM111	●▲	69	DM12-33	●	72
DD6	▲	64	DM112	●▲	69	DM123-4	●	69
DD7	▲	64	DM113	●▲	69	DM12-34	●	72

● Brass  
Ottone  
Messing  
Laiton  
Latón  
Latão

▲ Steel  
Acciaio  
Stahl  
Acier  
Acero  
Aço

■ Nickel silver  
Alpacca  
Neusilber  
Maillechort  
Alpaca  
Alpaca

◆ Iron  
Ferro  
Eisen  
Fer  
Hierro  
Ferro

C Available in Color  
Disponibile in Color  
Lieferbar in Color  
Disponibile en Color  
Disponibile en Color  
Disponível em Color

U Available in Ultralite  
Disponibile in Ultralite  
Lieferbar in Ultralite  
Disponibile en Ultralite  
Disponibile en Ultralite  
Disponível em Ultralite

S Available in Silky  
Disponibile in Silky  
Lieferbar in Silky  
Disponibile en Silky  
Disponibile en Silky  
Disponível em Silky

REF.		PAGE	REF.		PAGE	REF.		PAGE
DM123-5	●	69	DM14	●▲U	70	DM26R	●▲	72
DM12-35	●▲	72	DM141R	●	70	DM27	▲	71
DM123-6	●	69	DM144	■	71-231	DM28	●▲	69
DM12-36	●	72	DM145	■	71-231	DM29	●	72
DM123-7	●	69	DM149	▲	69	DM29R	●▲	72
DM12-37	●▲	72	DM150	▲	70	DM2R	▲	69
DM123-8	●	69	DM151R	●▲	70	DM3	●▲UC	70
DM12-38	●	72	DM152	▲	70	DM32	▲	70
DM123-9	●	69	DM153	▲	69	DM33R	●▲	72
DM12-39	●▲	72	DM154	▲	70	DM34	▲	69
DM12-4	●▲	72	DM154R	▲	70	DM34R	●▲	69
DM12-40	●	72	DM155	▲	70	DM35R	▲	70
DM12-41	●	72	DM16	●▲U	69	DM36	●▲	69
DM12-42	●	72	DM16R	●▲	69	DM36R	●▲	69
DM12-43	●	72	DM17	●▲	71	DM37	▲	69
DM12-44	●	72	DM17R	●▲	71	DM37R	●▲	69
DM12-45	●▲	72	DM18	●▲	72	DM38	●▲	69
DM12-46	●	72	DM18R	●▲	72	DM39	●▲	68
DM12-47	●	72	DM19	▲	69	DM39R	▲	68
DM12-5	●▲	72	DM19R	●▲	69	DM3X	▲UC	70
DM12-6	●▲	72	DM2	▲	69	DM4	●▲	68
DM12-7	●▲	72	DM20	●▲	70	DM40	●	72
DM128	●■	71-231	DM21	■	71-232	DM40R	●▲	72
DM12-8	●▲	72	DM22	■	70-232	DM41	●▲	69
DM12-9	●▲	72	DM22TV1	■	70-232	DM41R	●▲	69
DM12R-00	●▲	72	DM22TV10	■	70-232	DM42	●▲	72
DM12R-12	●▲	72	DM22TV2	■	70-232	DM42R	●▲	72
DM12R-13	●▲	72	DM22TV3	■	70-232	DM43	●	72
DM12R-16	●▲	72	DM22TV4	■	70-232	DM43R	●▲	72
DM12R-19	●▲	72	DM22TV5	●■	70-232	DM44	●▲	72
DM12R-31	●▲	72	DM22TV5X	●	71-232	DM44R	●▲	72
DM12R-32	●▲	72	DM22TV6	■	70-232	DM45	●■	72
DM12R-34	●▲	72	DM22TV7	■	70-232	DM45R	●▲	72
DM12R-35	●▲	72	DM22TV8	■	70-232	DM46	●▲	72
DM12R-36	●▲	72	DM22TV9	■	70-232	DM46R	●	72
DM13	▲	69	DM22TVP	●■	70-232	DM47	●▲	72
DM132	▲	70	DM22TVPX	●	71-232	DM47R	●▲	72
DM132R	▲	70	DM23	▲	69	DM48	▲	70
DM137	▲	69	DM23R	●▲	69	DM49	■	71-231
DM138	●	71-231	DM24	●■	71-232	DM4R	●▲	68
DM139	■	71-231	DM25	▲	70	DM5	▲	69
DM13R	▲	69	DM26	●▲	72	DM50	●	72

● Brass  
Ottone  
Messing  
Laiton  
Latón  
Latão

▲ Steel  
Acciaio  
Stahl  
Acier  
Acero  
Aço

■ Nickel silver  
Alpaca  
Neusilber  
Maillechort  
Alpaca  
Alpaca

◆ Iron  
Ferro  
Eisen  
Fer  
Hierro  
Ferro

Ⓒ Available in Color  
Disponibile in Color  
Lieferbar in Color  
Disponibile en Color  
Disponibile en Color  
Disponível em Color

⒰ Available in Ultralite  
Disponibile in Ultralite  
Lieferbar in Ultralite  
Disponibile en Ultralite  
Disponibile en Ultralite  
Disponível em Ultralite

Ⓔ Available in Silky  
Disponibile in Silky  
Lieferbar in Silky  
Disponibile en Silky  
Disponibile en Silky  
Disponível em Silky

REF.		PAGE	REF.		PAGE	REF.		PAGE
DM50R	▲	72	DM65-32	● ▲	73	DM72	● ▲	72
DM52	● ▲	69	DM65-33	● ▲	73	DM72R	● ▲	72
DM53	■	71-231	DM65-34	●	73	DM73	● ▲	72
DM55	● ▲	71-231	DM65-35	● ▲	73	DM73R	● ▲	72
DM57	●	69	DM65-36	● ▲	73	DM74	●	72
DM58	● ▲	71-232	DM65-4	● ▲	73	DM74R	● ▲	72
DM5R	▲	69	DM65-40	●	73	DM75	● ▲	72
DM6	● ▲	68	DM65-41	●	73	DM75R	● ▲	72
DM60	● ▲	72	DM65-42	●	73	DM76	● ▲	73
DM60R	●	72	DM65-43	●	73	DM76R	● ▲	73
DM61	● ▲	68	DM65-44	●	73	DM77	● ▲	73
DM61R	● ▲	68	DM65-45	●	73	DM77R	● ▲	73
DM62	● ▲	69	DM65-46	●	73	DM78	● ▲	73
DM62R	● ▲	69	DM65-5	●	73	DM78R	● ▲	73
DM63	● ▲ ■	69	DM65-6	● ▲	73	DM79	● ▲	73
DM63R	● ▲	69	DM65-7	●	73	DM79R	● ▲	73
DM64	■	71-232	DM65-8	● ▲ ■	73	DM8	● ▲ U	68
DM65-00	●	73	DM65-9	●	73	DM80	● ▲	73
DM65-1	● ▲	73	DM65R-00	●	73	DM80R	● ▲	73
DM65-10	● ■	73	DM65R-12	●	73	DM81	● ▲	73
DM65-11	●	73	DM65R-13	●	73	DM81R	● ▲	73
DM65-12	●	73	DM65R-16	●	73	DM82	● ▲	73
DM65-13	● ▲	73	DM65R-19	●	73	DM82R	● ▲	73
DM65-14	●	73	DM65R-31	●	73	DM83	●	73
DM65-16	● ■	73	DM65R-32	● ▲ ■	73	DM83R	● ▲	73
DM65-17	●	73	DM65R-34	●	73	DM84	● ▲	73
DM65-18	● ▲	73	DM65R-35	●	73	DM84R	● ▲	73
DM65-19	●	73	DM65R-36	●	73	DM85	● ▲	73
DM65-2	● ■	73	DM66	●	72	DM85R	● ▲	73
DM65-20	●	73	DM66R	● ▲	72	DM86	● ▲	73
DM65-21	● ▲	73	DM67	●	72	DM86R	● ▲	73
DM65-22	● ▲	73	DM67R	● ▲	72	DM87	● ▲	73
DM65-23	● ▲	73	DM68	● ▲	72	DM87R	● ▲	73
DM65-24	●	73	DM68R	● ▲	72	DM88	● ▲	73
DM65-25	●	73	DM69	●	72	DM88R	● ▲	73
DM65-26	●	73	DM69R	● ▲	72	DM89	● ▲	73
DM65-27	● ▲	73	DM6R	▲	68	DM89R	● ▲	73
DM65-28	● ▲	73	DM7	● ▲	70	DM8R	▲	68
DM65-29	● ▲	73	DM70	●	72	DM90	● ▲	73
DM65-3	●	73	DM70R	● ▲	72	DM90R	● ▲	73
DM65-30	● ▲	73	DM71	● ▲	72	DM91	● ▲	73
DM65-31	● ▲	73	DM71R	● ▲	72	DM91R	● ▲	73

● Brass  
Ottone  
Messing  
Laiton  
Latón  
Latão

▲ Steel  
Acciaio  
Stahl  
Acier  
Acero  
Aço

■ Nickel silver  
Alpacca  
Neusilber  
Maillechort  
Alpaca  
Alpaca

◆ Iron  
Ferro  
Eisen  
Fer  
Hierro  
Ferro

Ⓒ Available in Color  
Disponibile in Color  
Lieferbar in Color  
Disponibile en Color  
Disponibile en Color  
Disponível em Color

Ⓘ Available in Ultralite  
Disponibile in Ultralite  
Lieferbar in Ultralite  
Disponibile en Ultralite  
Disponibile en Ultralite  
Disponível em Ultralite

Ⓔ Available in Silky  
Disponibile in Silky  
Lieferbar in Silky  
Disponibile en Silky  
Disponibile en Silky  
Disponível em Silky

REF.		PAGE	REF.		PAGE	REF.		PAGE
DM92	● ▲	73	DX1	● ▲ U	66	ECM1R	▲	75
DM92R	● ▲	73	DX10R	● ▲	66	ED1	● ▲ U	80
DM93	● ▲	73	DX11R	● ▲	66	ED2	● ▲	80
DM93R	● ▲	73	DX12R	● ▲	66	ED3R	● ▲	80
DM94R	● ▲	73	DX13R	● ▲	66	ED4	● ▲	80
DM95	●	73	DX14R	● ▲	66	EF1R	● ▲	76
DM95R	●	73	DX15R	● ▲	66	EF2R	● ▲	76
DM96	● ▲	69	DX16R	● ▲	66	EF3R	● ▲	76
DM97R	● ▲	70	DX17R	▲	66	EF4R	● ▲	76
DM98R	● ▲	70	DX18R	▲	66	EF5R	● ▲	76
DMT1R	▲	67	DX19R	● ▲	66	EF6R	● ▲	76
DMT2R	▲	67	DX1R	● ▲ U	66	EF7	● ▲	76
DN1	● ▲	66	DX20R	● ▲	66	EG1	● ▲	75
DN2	● ▲ U	66	DX21R	● ▲	66	EG2	●	75
DN3	▲	66	DX22R	● ▲	66	EG2R	●	75
DN4	● ▲	66	DX23R	● ▲	66	EGR1	■	76
DN5	●	67	DX24R	● ▲	66	EK1	● ▲	78
DN6	● ▲	67	DX25R	● ▲	66	EK1R	● ▲	78
DN7	●	67	DX26R	● ▲	66	EK2	● ▲	78
DN8	● ▲	67	DX27R	● ▲	66	EK2R	● ▲	78
DN9R	▲	66	DX28R	● ▲	66	EK3	● ▲	78
DO10	▲	74	DX2R	▲	66	EK3R	●	78
DO11	● ▲	74	DX3	● ▲ U	66	EK4	● ▲	78
DO12	▲	74	DX3R	● ▲ U	66	EK4R	● ▲	78
DO13	● ▲	74	DX4R	● ▲	66	EL1	● ▲ U	76
DO1R	● ▲ U	74	DX5R	▲	66	EL10	▲	76
DO2R	● ▲	74	DX6R	▲	66	EL1C	▲ U	76
DO6	● ▲	74	DX7R	● ▲	66	EL1X	▲	76
DOW1R	●	75	DX8R	● ▲	66	EL2	▲	76
DP1	● ▲	75	DX9R	● ▲	66	EL3	▲	76
DP1R	● ▲	75	DY1	●	64	EL4	● ▲ U	76
DRC1	●	75	DY1R	●	64	EL5R	● ▲	76
DRS1R	●	75	<b>E</b>			EL6	▲	76
DS1	● ▲	74	EA1	● ▲	75	EL7R	● ▲	76
DS1R	● ▲	74	EA2	● ▲	75	EL9	●	76-232
DS2	▲	74	EA3	● ▲	75	ELK1	▲	76
DS3R	● ▲	74	EA4	● ▲	75	ELP1R	▲	76
DS4	● ▲	74	EAS1	●	75	EM1	● ▲	77
DS5R	● ▲	74	EBX1R	▲	78	EM11	▲	77
DS6	● ▲ ■	74-231	EC5	▲ ■	76-182-232-246	EM1R	●	77
DS7	●	74-232	ECM1	● ▲	75	EM2R	● ▲	77
DW1	▲	75				EM3	● ▲	77

● Brass  
Ottone  
Messing  
Laiton  
Latón  
Latão

▲ Steel  
Acciaio  
Stahl  
Acier  
Acero  
Aço

■ Nickel silver  
Alpaca  
Neusilber  
Maillechort  
Alpaca  
Alpaca

◆ Iron  
Ferro  
Eisen  
Fer  
Hierro  
Ferro

Ⓒ Available in Color  
Disponibile in Color  
Lieferbar in Color  
Disponibile en Color  
Disponibile en Color  
Disponível em Color

Ⓒ Available in Ultralite  
Disponibile in Ultralite  
Lieferbar in Ultralite  
Disponibile en Ultralite  
Disponibile en Ultralite  
Disponível em Ultralite

Ⓒ Available in Silky  
Disponibile in Silky  
Lieferbar in Silky  
Disponibile en Silky  
Disponibile en Silky  
Disponível em Silky



REF.		PAGE	REF.		PAGE	REF.		PAGE
EM3R	● ▲	77	EU6	▲	80	EV4	● ▲ U	80
EM4	● ▲	77	EU7	▲	79	EV4R	● ▲	80
EMK1	● ▲	77	EU9	▲	79	EV4RX	●	80
EMK13	▲	77	EUR1	▲	80	EV4X	●	80
EMK2	▲	77	EUS1	▲	80	EV5	● ▲	80
EMK3R	▲	77	EV10	● ▲ ■ U	80	EV5X	●	80
EMK5	▲	77	EV103X-1	▲	81	EV6	●	81
EMK6R	▲	77	EV103X-10	▲	81	EV64RX	●	80
EN1R	● ▲	77	EV103X-11	▲	81	EV69X	● ▲ G	80
EN2R	● ▲	77	EV103X-12	▲	81	EV6R	● ▲	81
ER1	● ▲	77	EV103X-2	▲	81	EV7	● ▲	81
ER2	▲	77	EV103X-3	▲	81	EV70	●	81
ER3R	▲	77	EV103X-4	▲	81	EV70R	●	81
ER4R	▲	77	EV103X-5	▲	81	EV7R	● ▲	81
ERT1	● ▲	77	EV103X-6	▲	81	EV8	● ▲	81
ES1	▲	77	EV103X-7	▲	81	EV81X	●	80
ES1R	▲	77	EV103X-8	▲	81	EV82X	●	80
ET1	●	78	EV103X-9	▲	81	EV8R	● ▲ U	81
ET1R	●	78	EV106	■	81-233	EV9	● ▲	80
ET2	● ▲	78	EV106R	■	81-233	EV9X	●	80
ET2R	● ▲	78	EV107	■	81-233	EVO1	▲	80
ETA1	● ▲	78	EV107R	■	81-233	EX1	● ▲	81
ETF1	▲	78	EV109X	●	80	EZ1	▲ U	82
EU10	▲	80	EV10X	● ▲ U	80	EZ2R	● ▲ U	82
EU10R	● ▲	80	EV10X1	● ▲ U	80	EZ3	▲ ■	81-233
EU11R	● ▲	78	EV11	● ▲	80	EZ3X	●	81-233
EU12	▲	78	EV110RX	▲	80	EZ4	●	81-233
EU13R	▲	79	EV111RX	▲	80	EZ4X	●	81-233
EU14	▲	79	EV118X	▲	80	EZ5	● S	81-233
EU15	▲	80	EV12	▲	80	EZ5X	●	81-233
EU16R	▲	79	EV122	■	81-233	EZ6	●	81-233
EU17	●	78-233	EV122R	■	81-233	EZ6X	●	81-233
EU18R	▲	78	EV2	● ▲	80	EZ7	▲	82
EU19	▲	78	EV21R	● ▲	81	<b>F</b>		
EU1R	● ▲ U	78	EV22R	● ▲	81	F1	●	89
EU2	▲	79	EV23R	● ▲	81	F1R	● ▲	89
EU20	● ▲	80	EV24R	● ▲	81	F2R	● ▲	89
EU2R	▲	79	EV2X	●	80	FAC10	● ▲	84
EU3	● ▲	78	EV3	● ▲ U	80	FAC10R	● ▲	84
EU4	▲	79	EV3R	● ▲ G	80	FAC11	● ▲	84
EU4R	▲	79	EV3RX	●	80	FAC12	▲	84
EU5R	● ▲	78	EV3X	▲ ■ G	80			

● Brass  
Ottone  
Messing  
Laiton  
Latón  
Latão

▲ Steel  
Acciaio  
Stahl  
Acier  
Acero  
Aço

■ Nickel silver  
Alpacca  
Neusilber  
Maillechort  
Alpaca  
Alpaca

◆ Iron  
Ferro  
Eisen  
Fer  
Hierro  
Ferro

G Available in Color  
Disponibile in Color  
Lieferbar in Color  
Disponibile en Color  
Disponibile en Color  
Disponível em Color

U Available in Ultralite  
Disponibile in Ultralite  
Lieferbar in Ultralite  
Disponibile en Ultralite  
Disponibile en Ultralite  
Disponível em Ultralite

S Available in Silky  
Disponibile in Silky  
Lieferbar in Silky  
Disponibile en Silky  
Disponibile en Silky  
Disponível em Silky

REF.		PAGE	REF.		PAGE	REF.		PAGE
FAC13	▲	84	FB13RX	●▲U	83	FB42R	●▲	82
FAC14	▲	84	FB13X	●	83	FB4R	●▲U	82
FAC15	●■	84-233	FB14R	●▲U	83	FB57R	●	83
FAC1R	▲	84	FB14RX	●▲U	83	FB5R	▲	82
FAC2	●▲	84	FB15R	●▲U	83	FB62RX	●	83
FAC29	▲	84	FB15RX	●▲U	83	FB62X	●	83
FAC2R	●▲	84	FB16R	●▲U	83	FB63X	●▲	83
FAC3	●▲	84	FB16RX	●U	83	FB64RX	●	83
FAC30	▲	84	FB17R	●▲U	83	FB64X	●	83
FAC31	●	84-233	FB17RX	●▲U	83	FB65R	●	83
FAC32	●	84-233	FB17X	●	83	FB69RX	●	83
FAC3R	▲	84	FB18R	●▲U	83	FB6R	●▲U	82
FAC4	●▲	84	FB18RX	●U	83	FB75R	●	83
FAC5	●▲	84	FB19R	●▲U	83	FB7R	●▲U	82
FAC5R	●▲	84	FB19RX	●▲U	83	FB81	●	82
FAC6	●▲	84	FB2	●▲U	82	FB81R	●	82
FAC6R	●▲	84	FB20R	●▲U	83	FB83R	●▲	83
FAC7	●▲U	84	FB20RX	●▲U	83	FB8R	▲	82
FAC8	▲	84	FB20X	●▲	83	FB9	●▲	82
FAC9	●▲U	84	FB21R	●▲U	83	FB97RX	●	83
FAI1R	▲	85	FB21RX	●▲	83	FB98X	●	83
FAI2	▲	85	FB22R	●▲U	83	FD1	●▲	90
FAI3	▲	85	FB22RX	●▲	83	FDR1	●	87
FAM1	●▲	85	FB23	●▲U	82	FDR2	▲	87
FAM1R	●▲	85	FB23R	●▲U	82	FEB1	●	53-87
FAM2	●▲	85	FB24	●▲U	82	FEB1R	●	53-87
FAM2R	●▲	85	FB25R	●▲U	83	FEB2	●▲	53-87
FAM3	●U	85	FB25RX	●▲U	83	FEB2R	●	53-87
FAM5	●U	85	FB26	●▲U	82	FEB6R	●	87
FAM6	●U	85	FB26R	●▲U	82	FF1	●▲U	87
FAM8	●	85	FB27R	●▲	83	FF10	●▲	87
FAM9	●	85	FB28R	●▲U	83	FF10R	●▲	87
FAN1	●▲U	85	FB28RX	●▲	83	FF11	●	88
FB1	●▲U	82	FB31	●	83	FF11R	●	88
FB103	▲	83	FB33	●▲	82	FF12	●▲U	88
FB104R	▲	83	FB33R	●▲	82	FF12R	●▲	88
FB105R	▲	83	FB34R	●▲U	83	FF13	●▲	88
FB108	●	83	FB35R	●▲	83	FF13R	●▲	88
FB10R	●U	82	FB36	●▲	83	FF14	●▲	87
FB11R	●▲U	82	FB36R	●▲	83	FF15	●▲	87
FB12R	●▲U	82	FB39X	●	83	FF16	●	88
FB13R	●▲U	83	FB3R	●▲U	82	FF17	▲	87

● Brass  
Ottone  
Messing  
Laiton  
Latón  
Latão

▲ Steel  
Acciaio  
Stahl  
Acier  
Acero  
Aço

■ Nickel silver  
Alpaca  
Neusilber  
Maillechort  
Alpaca  
Alpaca

◆ Iron  
Ferro  
Eisen  
Fer  
Hierro  
Ferro

Ⓒ Available in Color  
Disponibile in Color  
Lieferbar in Color  
Disponibile en Color  
Disponibile en Color  
Disponível em Color

Ⓒ Available in Ultralite  
Disponibile in Ultralite  
Lieferbar in Ultralite  
Disponibile en Ultralite  
Disponibile en Ultralite  
Disponível em Ultralite

Ⓒ Available in Silky  
Disponibile in Silky  
Lieferbar in Silky  
Disponibile en Silky  
Disponibile en Silky  
Disponível em Silky

REF.		PAGE	REF.		PAGE	REF.		PAGE
FF18	●	88	FH33	●	92-235	FM3R	● ▲	86
FF19	●	88-234	FH34R	●	92-235	FM4	● ▲	86
FF1R	● ▲	87	FH35	●	92-235	FM4R	● ▲	86
FF2	● ▲ U	87	FH36	●	92-235	FM5	● ▲	86
FF3	● ▲	87	FH37R	●	92-234	FM5P	● ▲	86
FF3R	● ▲	87	FH3R	▲	91	FM6	● ▲ U	86
FF4	● ▲	88	FH4	▲	91	FM7	● ▲	86
FF4R	●	88	FH4R	▲	91	FM8	●	86
FF5	●	88	FH5	▲	91	FMK1	● ▲	67
FF5R	● ▲	88	FH6	▲ U	91	FN1	●	85
FF6	● ▲	88	FH7	● ▲	90	FN2	●	85
FF6R	● ▲	88	FH8R	▲	91	FN4	●	85
FF7	● ▲	87	FH9	▲	91	FOS1	▲	90
FF7R	● ▲	87	FH9R	▲	91	FRE1R	▲	90
FF8	▲	87	FI064	● ▲	88	FRN1R	●	87
FF8R	● ▲	87	FI065	● ▲	88	FRT1	● ▲	90
FF9	● ▲	87	FI1	●	88	FRT4R	▲	90
FF9R	● ▲	87	FI1R	●	88	FRT5R	▲	90
FH1	▲	91	FI2	●	88	FRT6R	●	90
FH10R	▲	91	FI232	● ▲	88	FRT7	▲	90
FH11	▲	91	FI233	● ▲	88	FRT8	▲	90
FH12	●	92-234	FI234	● ▲	88	FRT9R	▲	90
FH13	▲	91	FI235	● ▲	88	FRZ1	● U	90
FH14	▲	91	FI3R	●	88-234	FRZ2	●	90
FH15	▲	91	FI4R	●	88-234	FS1	● ▲	85
FH16R	▲	91	FI6	●	88	FS1R	● ▲	85
FH17R	●	92-234	FID1	● ▲	89	FT15R	▲	89
FH18	▲	91	FIR1	▲	89	FT3	▲	89
FH19R	▲	91	FIR1R	▲	89	FT4	▲	89
FH1R	▲	91	FIR2R	▲	89	FT4C	▲	89
FH2	▲	91	FIR3	▲	89	FT500	●	89
FH20R	● ▲	91	FIS1	● ▲	90	FT500C	●	89
FH21R	▲	92	FIS1R	● ▲	90	FT510	●	89
FH22R	▲	92	FIS3	● ▲	90	FT5C	▲	89
FH23R	▲	92	FK1	● ▲	90	FU1	▲	92
FH24R	●	92	FL2	▲	90	FV1	▲	87
FH25	▲	91	FL2R	▲	90	FV2	▲	87
FH2R	▲	91	FLM1P	■	90	FV4	●	87-234
FH3	▲	91	FM090	● ▲ U C S	86	FVR1	●	86-234
FH30	▲	91	FM1	● ▲ U C	86	FVR2R	●	86-234
FH31L	● ▲	91	FM2	● ▲ U	86	FVR3	●	86-234
FH32	●	92-234	FM3	● ▲	86	FVR4R	●	86-234

● Brass  
Ottone  
Messing  
Laiton  
Latón  
Latão

▲ Steel  
Acciaio  
Stahl  
Acier  
Acero  
Aço

■ Nickel silver  
Alpacca  
Neusilber  
Maillechort  
Alpaca  
Alpaca

◆ Iron  
Ferro  
Eisen  
Fer  
Hierro  
Ferro

Ⓒ Available in Color  
Disponibile in Color  
Lieferbar in Color  
Disponibile en Color  
Disponibile en Color  
Disponível em Color

Ⓘ Available in Ultralite  
Disponibile in Ultralite  
Lieferbar in Ultralite  
Disponibile en Ultralite  
Disponibile en Ultralite  
Disponível em Ultralite

Ⓔ Available in Silky  
Disponibile in Silky  
Lieferbar in Silky  
Disponibile en Silky  
Disponibile en Silky  
Disponível em Silky

REF.		PAGE	REF.		PAGE	REF.		PAGE
FY1R	●	86-234	GE178RX-2	▲	94	GE4R	● ▲	93
<b>G</b>			GE178RX-3	▲	94	GE4RX	●	94
GAT1R	●	93-235	GE178RX-4	▲	94	GE4X	●	94
GB1	● ▲	93	GE178RX-5	▲	94	GE52X	● ▲	94
GB2	● ▲	93	GE178RX-6	▲	94	GE57	■	93-235
GB3	● ▲	93	GE178RX-7	▲	94	GE7R	● ▲ U	93
GB5	● ▲	93	GE17R	● ▲	94	GE7RX	● C	94
GB5R	●	93	GE18	● ▲	94	GE8R	● ▲ C	93
GBA1	▲	93	GE182X	▲	94	GE9	● ▲	93
GBL1R	▲	97	GE19R	● ▲	94	GEA4	●	93
GD1	▲	100	GE1R	● ▲	93	GF1	●	100-236
GD10	●	100	GE1RX	●	94	GJ3	●	98
GD10R	●	100	GE1X	● ▲ ■ U C	94	GL1	● ▲	98
GD1R	● ▲	100	GE2	● ▲	94	GL10	● ▲	97
GD2	▲	100	GE20	●	94	GL10R	●	97
GD3	●	100	GE21R	● ▲	94	GL11R	● ▲	97
GD4	● ▲	100	GE22	●	94	GL12R	● ▲	97
GD5	● ▲	100	GE23	●	94	GL13R	● ▲	97
GD6R	● ▲	100	GE23R	●	94	GL14	● ▲ U	98
GD7R	● ▲	100	GE24	●	94	GL17R	● ▲	97
GD8	● ▲ U	100	GE24R	●	94	GL18R	▲	98
GD8R	● ▲ U	100	GE25	●	94	GL19R	● ▲	98
GE1	● ▲ ■ U	93	GE25R	● ▲	94	GL1R	▲	98
GE106	● ▲	94	GE26	●	94	GL2	● ▲	97
GE106XL	●	94	GE26R	●	94	GL20	●	99
GE118	●	94	GE27	●	94	GL21R	●	98
GE119	●	93	GE27R	●	94	GL22R	●	98
GE119X	●	94	GE28	● ▲	94	GL2R	● ▲	97
GE14	● ▲	94	GE28R	●	94	GL3	● ▲	97
GE15	●	94	GE29	●	94	GL3R	● ▲	97
GE15R	● ▲	94	GE29R	●	94	GL4	● ▲	97
GE16	●	94	GE2R	● ▲	94	GL4R	●	97
GE16R	● ▲	94	GE3	● ■ U	94	GL5	● ▲	97
GE17	● ▲	94	GE30	● ▲	94	GL5R	●	97
GE178RX-1	▲	94	GE30R	●	94	GL6	● ▲ U	97
GE178RX-11	▲	94	GE31	● ▲	94	GL6R	● ▲	97
GE178RX-12	▲	94	GE31R	● ▲	94	GL7	● ▲ U	97
GE178RX-13	▲	94	GE32	● ▲	94	GL7R	● ▲	97
GE178RX-15	▲	94	GE34	●	93	GL8	● ▲ U	97
GE178RX-16	▲	94	GE34X	●	94	GL9	● ▲	97
GE178RX-17	▲	94	GE3R	▲	94	GL9R	● ▲	97
			GE4	● ▲	93	GLZ1	▲	97

● Brass  
Ottone  
Messing  
Laiton  
Latón  
Latão

▲ Steel  
Acciaio  
Stahl  
Acier  
Acero  
Aço

■ Nickel silver  
Alpaca  
Neusilber  
Maillechort  
Alpaca  
Alpaca

◆ Iron  
Ferro  
Eisen  
Fer  
Hierro  
Ferro

C Available in Color  
Disponibile in Color  
Lieferbar in Color  
Disponibile en Color  
Disponibile en Color  
Disponível em Color

U Available in Ultralite  
Disponibile in Ultralite  
Lieferbar in Ultralite  
Disponibile en Ultralite  
Disponibile en Ultralite  
Disponível em Ultralite

S Available in Silky  
Disponibile in Silky  
Lieferbar in Silky  
Disponibile en Silky  
Disponibile en Silky  
Disponível em Silky

REF.		PAGE	REF.		PAGE	REF.		PAGE
GN1	● ▲	96	GS6	● ▲	96	GYE8	▲	216
GO1R	▲	98	GS7	● ▲	96	GYF	● ▲	216
GO2R	▲	98	GS8	● ▲	96	GYF6	● ▲	217
GO3	●	98	GS9	●	96	GYF7	● ▲	216
GO4R	● U	98	GSS1	●	100	GYF8	● ▲	216
GO5	●	98	GT1	● ▲	96	GYG	●	216
GO6	■	98-235	GT1R	●	96	GYG6	●	217
GO7	■	98-235	GT3	●	96	GYG7	● ▲	216
GOD4R	▲	98	GT3R	●	96	GYG8	▲	216
GP1	● ▲	96	GT4	● ▲	46-95	GYGB7	●	216
GPI1	●	99-235	GT4R	● ▲	46-95	GYH	●	216
GR15	●	95	GUR1	●	101	GYH6	● ▲	217
GR16	▲	95	GUS1	▲	101	GYH7	▲	216
GR1R	▲	95	GV1	▲	100	GYH8	▲	216
GR2R	▲	95	GV2	▲	100	GYK	● ▲	216
GR3	●	95	GV3	▲	100	GYK6	● ▲	217
GR4	●	95	GV4R	▲	100	GYK7	● ▲	216
GR9-5	▲	95	GV5R	▲	100	GYK8	▲	216
GR9-7	▲	95	GV6R	▲	100	GYP5A	● ▲	216
GR9-8	▲	95	GV7	▲	100	GYP5B	▲	216
GR9-9	▲	95	GVY1R	●	95-235	GYP5D	● ▲	216
GR9R-1	▲	95	GVY2R	●	95-235	GYP6B	▲	217
GR9R-2	▲	95	GWS1	●	95	GYP7	● ▲	216
GR9R-3	▲	95	GYA	●	216	GYP7R	●	216
GR9R-4	▲	95	GYA6	●	217	GYP8	●	216
GR9R-5	▲	95	GYA7	● ▲	216	GYP8R	●	216
GR9R-6	▲	95	GYA8	●	216	<b>H</b>		
GS1	● ▲ U	96	GYB	●	216	H1	● ▲	102
GS10	● ▲	96	GYB6	●	217	H1R	▲	102
GS10R	● ▲	96	GYB7	● ▲	216	HA1R	●	101
GS11R	● ▲	96	GYB8	●	216	HAG1	● U	101
GS12R	●	96	GYC	● ▲	216	HAG1R	● U	101
GS13	● ▲	96	GYC6	●	217	HAG5	●	101
GS17	●	96-235	GYC7	● ▲	216	HAG6R	●	101
GS1R	● ▲	96	GYC8	●	216	HAG7	●	101
GS2	● ▲	96-141	GYD	●	216	HAG7R	●	101
GS2R	●	96-141	GYD6	●	217	HAK1	● ▲	116
GS3	● ▲	38-96	GYD7	● ▲	216	HAK2	● ▲	116
GS3R	● ▲	38-96	GYD8	▲	216	HAK3	▲	116
GS4	● ▲	96	GYE	● ▲	216	HAK4	▲	116
GS4R	● ▲	65-96	GYE6	●	217	HAK6	▲	116
GS5	● ▲	96	GYE7	● ▲	216			

● Brass  
Ottone  
Messing  
Laiton  
Latón  
Latão

▲ Steel  
Acciaio  
Stahl  
Acier  
Acero  
Aço

■ Nickel silver  
Alpacca  
Neusilber  
Maillechort  
Alpaca  
Alpaca

◆ Iron  
Ferro  
Eisen  
Fer  
Hierro  
Ferro

Ⓒ Available in Color  
Disponibile in Color  
Lieferbar in Color  
Disponibile en Color  
Disponibile en Color  
Disponível em Color

U Available in Ultralite  
Disponibile in Ultralite  
Lieferbar in Ultralite  
Disponibile en Ultralite  
Disponibile en Ultralite  
Disponível em Ultralite

Ⓔ Available in Silky  
Disponibile in Silky  
Lieferbar in Silky  
Disponibile en Silky  
Disponibile en Silky  
Disponível em Silky

REF.		PAGE	REF.		PAGE	REF.		PAGE
HCT1R	▲	102	HO2R	●▲U	103	ID3	●	107
HD1	●▲	103	HOK1R	●	102-236	IE1	●▲	108
HD1R	●▲	103	HOK2R	●	102-236	IE10	●▲	108
HD2	●	103	HP1R	▲	101	IE12	●▲	108
HD2R	●▲	103	HPP1	▲	103	IE13	▲	108
HD3	▲	103	HPP1R	●▲	103	IE14	●U	108-236
HD8R	▲	103	HR1	●▲U	103	IE15	●G	108-236
HDL1R	●U	102	HS1R	●▲	101	IE1R	●	108
HDL3	●	101	HT1	●▲	103	IE2	●▲U	108
HDL3R	●	101	HT1R	●▲	103	IE224	●▲U	108
HE1	▲	102	HT2	●▲	103	IE225	●▲U	108
HE1R	▲	102	HTE1	●	103-236	IE26	●S	109-237
HE2	●▲	102	HUT1	●	104	IE26P	●	109-237
HE2R	●▲	102	HW1	●▲	104	IE27R	●▲	108
HE3	●▲	102	HW15R	▲	104	IE28R	●	108
HE3R	●▲	102	HW1P	●	104	IE29	▲	108
HEN1	●▲	102	HW2	▲	104	IE2R	●▲U	108
HF1R	●▲	101	HW21R	●	104	IE3	●▲UGS	108
HF73R	▲	101	HW3	▲	104	IE30	●	109-236
HF74	●▲	101	HW4	●▲	104	IE31	●▲	108
HF74R	▲	101	HW4R	●▲	104	IE3R	●▲	108
HF75	▲	101	<b>I</b>			IE4	●U	108
HF75R	●▲	101	IAB7	●	107	IE4R	●	108
HG1	●▲	103	IAB8	●	107	IE5	●▲G	108
HG2	●▲	103	IAB9	●	107	IE5R	●	108
HG3	●▲	103	IB1	●▲U	108	IE6	●▲UGS	108
HG4	●▲	103	IBF1	●▲	104	IE6R	●▲U	108
HG5	●▲	103	IBF1R	●▲	104	IE6X	▲	108
HG6	●▲	103	IBF2R	●	104-236	IE7	●▲US	108
HGO1R	●	104-236	IBF3R	●	104-236	IE7R	▲U	108
HGO2R	▲	104	IBM1	▲	105	IE8	●	108
HL1R	●	102	ICA1R	▲	105	IE8R	●▲	108
HN1	●▲	102	ICS1	●	105	IE9	●▲	108
HN1P	●	102	ICS1R	●	105	IEH1	●	212
HN2	●▲	102	ICS2	●▲	105	IES1R	●	105
HN3	▲	102	ICS2R	●▲	105	IF1	▲	105
HN3R	▲	102	ICS3	●	105	IF12R	▲	106
HN4	▲	102	ICS3R	●	105	IF13R	▲	106
HN5R	▲	102	ICS5	▲	105	IF14	●	106-236
HN6	▲	102	ID1	●▲	107	IF2	▲U	105
HN7	▲	102	ID2	▲	107	IF2R	▲	105
HO1R	●▲	103				IF3	●▲U	105

● Brass  
Ottone  
Messing  
Laiton  
Latón  
Latão

▲ Steel  
Acciaio  
Stahl  
Acier  
Acero  
Aço

■ Nickel silver  
Alpaca  
Neusilber  
Maillechort  
Alpaca  
Alpaca

◆ Iron  
Ferro  
Eisen  
Fer  
Hierro  
Ferro

G Available in Color  
Disponibile in Color  
Lieferbar in Color  
Disponibile en Color  
Disponibile en Color  
Disponível em Color

U Available in Ultralite  
Disponibile in Ultralite  
Lieferbar in Ultralite  
Disponibile en Ultralite  
Disponibile en Ultralite  
Disponível em Ultralite

S Available in Silky  
Disponibile in Silky  
Lieferbar in Silky  
Disponibile en Silky  
Disponibile en Silky  
Disponível em Silky

REF.		PAGE	REF.		PAGE	REF.		PAGE
IF3R	▲	105	ITO2	● ▲	109	JOW5	● ▲	110
IF4	● ▲	106	ITO3	●	109	JOW6	▲	110
IF4R	● ▲	106	ITO3R	●	109	JOW7	● ▲	110
IF5	● ▲	106	IW1R	●	109	JOW8	▲	110
IF5R	● ▲	106	IX1	● ▲	104	JOW9	▲	110
IF6	● ▲ U	105	IX1R	● ▲	104	JPN1	● ▲	109
IF7	▲	105	<b>J</b>			JPN2	● ▲	109
IF7R	▲	105	JAR1	● ▲	110	JPN3R	● ▲	109
IF8	▲	105	JAR1R	● ▲	110	JR1R	▲	111
IF8R	▲	105	JAR2	● ▲	110	JS1	● ▲	110
IJ1	▲	106	JAR2R	● ▲	110	JS1R	● ▲	110
IL1	● ▲	106	JB1	▲	109	JS2	● ▲ U S	110
IL1R	● ▲	106	JC1	● ▲	112	JS2R	● ▲	110
ILC13R	●	106	JC2R	● ▲	112	JS3	● ▲	110
ILC2	●	106	JH1	●	110	JS3R	● ▲	110
ILC3	● ▲	106	JL1	▲	113	JS4	● ▲	110
ILC6	●	106	JL2	● ▲	113	JS4R	● ▲	110
ILS1	●	107	JL2R	● ▲	113	JS5P	●	110
IN1	● ▲	106	JL3	●	112	JT1	▲	111
IN2	● ▲	106	JL3R	● ▲	112	JT2R	▲	111
IN3	● ▲	106	JL4	● ▲	113	JT3R	▲	111
IN5	●	107	JL4R	● ▲	113	JU1	● ▲	112
ING1	● ▲	107	JL5	● ▲	113	JU10	▲	112
ING2	● ▲	107	JM1	● ▲	6-111	JU11	● ▲	111
ING3	▲	107	JM1R	▲	6-111	JU11R	● ▲	111
ING4R	●	107	JM2	● ▲	6-111	JU12	● ▲	111
ING5	● ▲	107	JM2R	▲ U C S	6-111	JU13R	● ▲	111
ING6	● ▲	107	JM3	● ▲	111	JU14	▲	111
INS1	● ▲	107	JM3R	▲	111	JU1R	▲	112
INS1R	● ▲	107	JM6	▲	111	JU2	▲	112
IO1	●	109-237	JM7	▲	111	JU2R	▲	112
IO2R	●	109-237	JN1R	● ▲	111	JU3	● ▲	111
IR1	●	108-236	JOW1	● ▲	110	JU4	● ▲	111
IS1	● ▲	106	JOW10	▲	110	JU5	● ▲	111
IS2	● ▲	106	JOW11	● ▲	110	JU6	● ▲	111
ISP2	● ▲	105	JOW12RX	▲	110	JU7	● ▲	112
ISP4	● ▲	105	JOW12X	▲	110	JU8	▲	111
IT1	● ▲	107	JOW1R	▲	110	JU9	▲	111
IT1R	● ▲	107	JOW2	● ▲	110	JW1	●	112
IT2	● ▲	108	JOW3R	● ▲	111	JW10	● ▲	112
IT2R	● ▲	108	JOW4R	▲	111	JW10R	● ▲	112
ITO1R	●	109				JW11	● ▲	112

● Brass  
Ottone  
Messing  
Laiton  
Latón  
Latão

▲ Steel  
Acciaio  
Stahl  
Acier  
Acero  
Aço

■ Nickel silver  
Alpacca  
Neusilber  
Maillechort  
Alpaca  
Alpaca

◆ Iron  
Ferro  
Eisen  
Fer  
Hierro  
Ferro

Ⓒ Available in Color  
Disponibile in Color  
Lieferbar in Color  
Disponibile en Color  
Disponibile en Color  
Disponível em Color

Ⓘ Available in Ultralite  
Disponibile in Ultralite  
Lieferbar in Ultralite  
Disponibile en Ultralite  
Disponibile en Ultralite  
Disponível em Ultralite

Ⓔ Available in Silky  
Disponibile in Silky  
Lieferbar in Silky  
Disponibile en Silky  
Disponibile en Silky  
Disponível em Silky

REF.		PAGE	REF.		PAGE	REF.		PAGE
JW12	● ▲	112	KE1	● ■ C	115-238	KI13	● ▲	117
JW13	● ▲	112	KE11	■	116-238	KI14	▲	117
JW13R	● ▲	112	KE13	■ S	116-238	KI15	▲	117
JW1R	●	112	KE19	■	116-239	KI15R	▲	117
JW2	● ▲	112	KE2	■	115-238	KI16	● ▲	117
JW2R	●	112	KE3	● ■ U C	115-238	KI4	● ▲	117
JW3	● ▲	112	KE4	■	115-165-238-244	KI4R	● ▲	117
JW4	●	112	KE9	■ C	115-238	KI5	● ▲	117-159
JW4R	● ▲	112	KE1R	●	115	KI5R	● ▲	117-159
JW5	● ▲	112	KER1	▲	116	KI6	● ▲	117
JW5R	● ▲	112	KEY1	▲	116	KI7	▲	117-159
JW6	●	112	KEY1R	▲	116	KI7R	● ▲	117
JW6R	● ▲	112	KEY2	▲	116	KI8	▲	93-117
JW7	●	112	KF1	● ▲ U C	116	KI8R	▲	93-117
JW7R	● ▲	112	KFA	● ▲	116	KI9	● ▲	117
JW8	● ▲	112	KFB	● ▲	116	KI9R	● ▲	117
JW9	● ▲	112	KFC	● ▲	116	KIR1	▲	118
JW9R	● ▲	112	KFD	● ▲	116	KIV1R	▲	118
<b>K</b>			KFE	● ▲	116	KIV2R	▲	118
KA1	● ■ U C S	113-237	KFF	● ▲	116	KK1	● ▲	207
KA2	● ■	113-237	KFG	● ▲	116	KL1	● ▲	118
KA3	● ■	113-237	KFH	● ▲	116	KL1R	● ▲	118
KA4	■	113-237	KFI	● ▲	116	KL2	▲	118
KA5	● ■	113-237	KFJ	● ▲	116	KL2R	● ▲	118
KA6	■	113-237	KFK	● ▲	116	KLE1	● U	114-238
KA7	■	113-237	KFL	● ▲	116	KLE10R	● U	114-238
KA8	■	113-237	KFM	● ▲	116	KLE11	● U	114-238
KA9	● ■	113-237	KFN	● ▲	116	KLE2R	●	114-238
KAK1	■	114-238	KFO	● ▲	116	KLE3R	● ▲ U	114
KAP1	● ▲	114	KFR	● ▲	116	KLE3RX	▲	114
KAP1R	● ▲	114	KFS	● ▲	116	KLE3X	▲	114
KAX1	●	113-237	KFU	● ▲	116	KLE4	● U	114-238
KAX1R	●	113-237	KFW	● ▲	116	KLE5RX	▲	114
KAZ1R	▲	115	KFX	● ▲	116	KLE5X	▲	114
KAZ2	▲	115	KG1	● ▲	118	KLE6RX	▲ U	114
KAZ2R	▲	115	KG2	●	118	KLE6X	▲	114
KAZ3R	▲	115	KI10	▲	93-117	KLE7RX	● ▲ U S	114
KAZ4R	▲	115	KI10R	▲	93-117	KLE7X	● ▲ U	114
KAZ5R	▲	115	KI11	● ▲	117	KLE8R	●	114-238
KAZ7R	▲	115	KI11R	▲	117	KLE9R	●	114-238
KAZ8R	▲	115	KI12	● ▲	117-159	KL1R	▲	114
			KI12R	▲	117-159	KL2R	▲	114

● Brass  
Ottone  
Messing  
Laiton  
Latón  
Latão

▲ Steel  
Acciaio  
Stahl  
Acier  
Acero  
Aço

■ Nickel silver  
Alpaca  
Neusilber  
Maillechort  
Alpaca  
Alpaca

◆ Iron  
Ferro  
Eisen  
Fer  
Hierro  
Ferro

C Available in Color  
Disponibile in Color  
Lieferbar in Color  
Disponibile en Color  
Disponibile en Color  
Disponível em Color

U Available in Ultralite  
Disponibile in Ultralite  
Lieferbar in Ultralite  
Disponibile en Ultralite  
Disponibile en Ultralite  
Disponível em Ultralite

S Available in Silky  
Disponibile in Silky  
Lieferbar in Silky  
Disponibile en Silky  
Disponibile en Silky  
Disponível em Silky



REF.		PAGE	REF.		PAGE	REF.		PAGE
KM1	▲	118	LC11	●▲⓪Ⓢ	123	LF11R	●▲	79-128
KM1R	●▲	118	LC11R	▲⓪	123	LF13	▲	79-128
KMT1	▲	118	LC12	▲	123	LF15R	▲	79-128
KMT2R	▲	118	LC13	▲	123	LF16	●▲	79-128
KNA1	●▲	119	LC13R	▲	123	LF16R	●▲	79-128
KNA2	▲	119	LC14R	●■Ⓢ	123-239	LF17	▲	79-128
KOB1	▲	118	LC15	▲	123	LF18R	●▲	79-128
KP1	●	118	LC15R	▲	123	LF2	●▲⓪	79-128
KPP1	▲	118	LC16	▲	123	LF20	●▲	79-128
KRE1	▲	118	LC17	▲	123	LF20R	●▲	79-128
KS1	●▲⓪	119	LC17R	▲	123	LF22	●▲	79-128
KS1FT	●▲⓪	119	LC1R	▲	123	LF22R	●▲	79
KS4	●⓪	119	LC2	●▲⓪	123	LF23R	●▲	79
KZ1	▲	117	LC25	▲	123	LF24	●▲⓪	129
KZ2	▲	117	LC25R	▲	123	LF25	●▲⓪	129
KZ3	▲	117	LC26R	●	123-239	LF26	●▲	79-128
<b>L</b>			LC2R	▲⓪	123	LF27	●▲⓪	129
LAF1	●⓪	119	LC3	▲⓪	123	LF27R	●	129
LAF2	●⓪	119	LC3R	▲⓪	123	LF28R	▲	129
LAF4R	●	119	LC4	▲	123	LF29R	▲	79-129
LAF5	●	120	LC4R	▲	123	LF30R	●▲	79-129
LAF6	●	120	LC5	▲	123	LF31R	●▲⓪	129
LAF7	●	120	LC5R	●▲	123	LF33	▲	129
LAF8	●	120	LC6	▲	123	LF34	●▲	129
LAP1	●▲	121	LC6R	▲	123	LF37	●▲	129
LAP2	▲	67-121	LC7	▲	123	LF39	●▲⓪	129
LAP3	▲	67-121	LC7R	▲	123	LF4	●▲⓪	79-128
LB10	●▲■	122	LC8	●▲	123	LF42R	▲	128
LB11	●▲	122	LC8R	▲	123	LF43R	●▲⓪	129
LB18	●▲	122	LC9	▲	123	LF44	●▲	130
LB19	●▲	122	LC9R	▲	123	LF45R	●▲	130
LB22	●▲	122	LCK1R	●▲	126-239	LF46R	●▲	130
LB23	●▲	122	LCK1RX	●	126-239	LF47	▲	129
LB28	●	122	LD4	▲	119	LF4R	▲	79-128
LB29	●	122	LD4R	▲	119	LF51R	▲	129
LB32	●▲	122	LD5R	●▲	119	LF52	▲	128
LB33	●▲■	122	LEA1	●	122-239	LF53	▲	130
LB34	●▲■	122	LEA2	▲	122	LF54	●	129
LB35	●▲	122	LEG1	●▲	122	LF56	▲	130
LC1	▲	123	LEG2	●▲	122	LF57	●	128
LC10	▲	123	LEG3	●▲	122	LF58R	▲	130
			LF11	●▲	79-128	LF59R	▲	130

● Brass  
Ottone  
Messing  
Laiton  
Latón  
Latão

▲ Steel  
Acciaio  
Stahl  
Acier  
Acero  
Aço

■ Nickel silver  
Alpacca  
Neusilber  
Maillechort  
Alpaca  
Alpaca

◆ Iron  
Ferro  
Eisen  
Fer  
Hierro  
Ferro

⓪ Available in Color  
Disponibile in Color  
Lieferbar in Color  
Disponibile en Color  
Disponibile en Color  
Disponível em Color

⓪ Available in Ultralite  
Disponibile in Ultralite  
Lieferbar in Ultralite  
Disponibile en Ultralite  
Disponibile en Ultralite  
Disponível em Ultralite

Ⓢ Available in Silky  
Disponibile in Silky  
Lieferbar in Silky  
Disponibile en Silky  
Disponibile en Silky  
Disponível em Silky

REF.		PAGE	REF.		PAGE	REF.		PAGE
LF6	●▲U	79-128	LM4R	▲	130	LP39R	●▲	124
LF60	●▲	130	LM5P	▲	130	LP3R	▲	124
LF61R	●▲	129	LMA1	▲	120	LP40	▲	124
LF62	●	129	LN1	●	125	LP41	▲	124
LF6R	●▲U	79-128	LOB1	▲	125	LP42	●	124
LF7	▲	79-128	LOB10R	▲	125	LP43	●▲	124
LF8	●▲	79-128	LOB11R	●	125	LP44	●	124
LF8R	▲	79-128	LOB13	▲	126	LP45	●	124
LH1	●▲U	120	LOB16	●	126	LP48	●▲	124
LH10	●▲	121	LOB1R	●▲U	125	LP49	●▲	124
LH10R	▲	121	LOB9R	▲	125	LP5	●▲UGS	124
LH13P	■	120-239	LOC1	●U	126	LP50	●▲	124
LH14P	■	120-239	LOC3	●	126	LP51	●▲	124
LH15P	■	120-239	LOC4	●	126	LP52	●▲	124
LH16P	■	120-239	LOK2	●	128-239	LP53	●▲	124
LH17P	■	120-239	LP10	●▲	124	LP57R	●▲	124
LH18P	■	120-239	LP10R	●▲	124	LP5R	●▲	124
LH2	●▲	121	LP11	■	115-124-238-239	LP6	●▲	125
LH20	▲	121	LP12	●▲	124	LP7	▲	124
LH21	▲	121	LP12R	●▲	124	LP7R	▲	124
LH22	▲	121	LP13	▲	124	LP8	▲	124
LH23	▲	121	LP13R	▲	124	LP8R	●▲	124
LH24	▲	121	LP14	●▲	125	LP9	●▲	124
LH25	▲	121	LP14R	●▲	125	LP9R	●▲	124
LH26	▲	121	LP15	●▲	125	LS1	●▲	121-159
LH27	▲	121	LP15R	●▲	125	LS10	▲	121
LH28	▲	121	LP16	●▲	125	LS11	●▲	122
LH29	▲	121	LP16R	●	125	LS11R	●▲	122
LH3	▲	121	LP17R	●▲	124	LS12	▲	121
LH4	▲	120	LP18R	●▲	124	LS13	●▲U	122
LH40	▲	120	LP19R	●▲	124	LS13R	●▲	122
LH41P	■	120-239	LP2	●▲	124	LS14	●▲	122
LH42	▲	120	LP20R	▲	124	LS14R	●▲	122
LH43R	▲	120	LP21	●▲■UGS	124	LS15	●▲	122
LH5	●▲	121	LP21-OV	●▲U	124	LS17	●▲	122
LH5R	▲	121	LP2R	●▲	124	LS18	●▲	122
LH6R	●▲	121	LP3	▲U	124	LS19	●▲	121
LH7R	●▲	121	LP35R	●	124	LS1R	●▲	121-159
LL1	●▲	122-126	LP36R	●	124	LS2	●▲	121-159
LM3	▲	130	LP37R	●	124	LS3	▲	121
LM3R	▲	130	LP38R	●▲	124	LS3R	▲	121
LM4	▲	130	LP39	●	124	LS4	▲	121

● Brass  
Ottone  
Messing  
Laiton  
Latón  
Latão

▲ Steel  
Acciaio  
Stahl  
Acier  
Acero  
Aço

■ Nickel silver  
Alpaca  
Neusilber  
Maillechort  
Alpaca  
Alpaca

◆ Iron  
Ferro  
Eisen  
Fer  
Hierro  
Ferro

Ⓒ Available in Color  
Disponibile in Color  
Lieferbar in Color  
Disponibile en Color  
Disponibile en Color  
Disponível em Color

Ⓢ Available in Ultralite  
Disponibile in Ultralite  
Lieferbar in Ultralite  
Disponibile en Ultralite  
Disponibile en Ultralite  
Disponível em Ultralite

Ⓣ Available in Silky  
Disponibile in Silky  
Lieferbar in Silky  
Disponibile en Silky  
Disponibile en Silky  
Disponível em Silky

REF.		PAGE	REF.		PAGE	REF.		PAGE
LS4R	▲	121	LW4R	●▲U	127	MAU5R	▲	132
LS5	▲	122	LW5	●▲U	127	MAY1	●	133
LS6	▲	122	LW5R	●	127	MB1	●	141
LS7	●▲	121	LW6	●▲	127	MBL1	●▲	141
LS9	●▲	122	LW7	●▲	127	MBL1R	●▲	141
LS9R	●▲	122	LW8	●▲	127	MBS300	●	270
LT1	●▲	35-125	LW9	●▲	127	MBS301	●	270
LT2	●▲U	125	LX1	▲	130	MC1	●▲	133
LT3	▲	125	LX1R	▲	130	MC10R	●	134-240
LT4	●▲U	125	LXM1R	▲	130	MC11	▲	134
LT5	●	125	LYA	●	217	MC12	●▲U	134
LT6R	●	125	LYA6	●▲	217	MC13	▲	134
LU1	●▲	130	LYB	●▲	217	MC14R	●	134-240
LU2	●▲U	130	LYB6	●	217	MC15R	●	134-240
LU3R	●▲U	130	LYC	●▲	217	MC17	▲	133
LU4	▲U	130	LYC6	●▲	217	MC18R	●	134
LW1	●▲	127	LYD	●	217	MC19R	●	134
LW10	●▲	127	LYD6	●▲	217	MC1R	●	133
LW11	●▲	127	LYE	●	217	MC2	●▲U	133
LW12R	●▲	128	LYE6	●	217	MC20	▲	134
LW13	●▲	128	LYF	●▲	217	MC21	▲	134
LW14	●▲U	128	LYF1T	●	130	MC22	▲	133
LW15	●▲	128	LYF2T	●	130	MC22R	▲	133
LW16	●▲	126	LYF6	●▲	217	MC23	▲	133
LW17	●▲	126	LYG	●	217	MC24	▲	134
LW18	●▲U	127	LYG6	●▲	217	MC25	▲	134
LW19	●	127	LYH	●	217	MC26R	●	134-240
LW1R	●▲	127	LYH6	●▲	217	MC2R	●▲U	133
LW2	●▲U	127	LYK	●▲	217	MC3	▲U	133
LW20	●▲	127	LYK6	●	217	MC4	▲U	133
LW20R	●▲	127	LYP5A	●▲	217	MC4R	●▲	133
LW21R	●▲	127	LYP5B	▲	217	MC5	●▲	133
LW23	●	127	LYP5D	▲	217	MC5R	●▲U	133
LW24	●▲	127	LYP6A	▲	217	MC6	●▲	133
LW28	●	127	LYP6D	▲	217	MC6R	●▲	133
LW29	●	127				MC7	▲	133
LW2R	●▲	127				MC8	▲	133
LW3	●▲U	128				MC9X	●	134-240
LW34	●	126				MD11	■	135
LW4	●▲UCS	127				MD1R	●▲■	135
LW40	●	127				MD4	●■	135
LW40R	●▲	127				MD6	●	135

● Brass  
Ottone  
Messing  
Laiton  
Latón  
Latão

▲ Steel  
Acciaio  
Stahl  
Acier  
Acero  
Aço

■ Nickel silver  
Alpacca  
Neusilber  
Maillechort  
Alpaca  
Alpaca

◆ Iron  
Ferro  
Eisen  
Fer  
Hierro  
Ferro

Ⓒ Available in Color  
Disponibile in Color  
Lieferbar in Color  
Disponibile en Color  
Disponibile en Color  
Disponível em Color

Ⓘ Available in Ultralite  
Disponibile in Ultralite  
Lieferbar in Ultralite  
Disponibile en Ultralite  
Disponibile en Ultralite  
Disponível em Ultralite

Ⓔ Available in Silky  
Disponibile in Silky  
Lieferbar in Silky  
Disponibile en Silky  
Disponibile en Silky  
Disponível em Silky

REF.		PAGE	REF.		PAGE	REF.		PAGE
MD7	●	135	MER34R	● ▲	138	MI3	● ▲	142
MD8R	●	135	MER35R	● ▲	138	MI3R	● ▲	142
ME1	▲	135	MER36	●	138	MI5	● ▲	142
ME10R	● ▲	136	MER37	●	138	MI5R	● ▲	142
ME2R	▲	135	MER38	●	138-241	MI7	▲	142
ME3	▲	135	MER39	●	138-241	MI7R	▲	142
ME4	● ▲	135	MER4	● ▲	136	MI8	●	142
ME4R	▲	135	MER41	●	138	MIG1	● ▲	142
ME5	▲	135	MER42R	▲	138	MIG1R	● ▲	142
ME5R	▲	135	MER4R	● ▲	136	MIG2	● ▲	142
ME6	● ▲	135	MER5	● ▲	136	MIG2R	● ▲	142
ME7	▲	135	MER6	● ▲	136	MIL1	▲	139
ME8	▲	135	MER6R	● ▲	136	MIL2	▲	139
ME9	▲	136	MER7R	●	136	MIS1	◆	140-269
MEC1	● ▲	135	MER8	● ▲ U C S	137	MIS2	◆	140-269
MEG1R	●	135-241	MER9R	●	137	MIW1	● ◆	140
MEG2	▲	135	MET1	▲	139-150	MIW13	●	140
MER1	● ▲ C	136	MF1R	● ▲	135	MIW14	● ■	140
MER10R	●	137	MFA1	▲	135	MIW15	■	140
MER11R	● ▲	137	MG1	● ▲	139	MIW2	●	140
MER12R	●	137	MG1R	● ▲	139	MIW3	● ■	140
MER13R	● ▲ U	137	MG2	●	139	MIW4	●	140
MER14R	●	137	MG2R	● ▲	139	MIW5	●	140
MER15R	●	137	MG3	●	139	MIW6	●	140
MER16R	●	137	MG3R	● ▲	139	MIW7	●	140
MER17R	● ▲	137	MG8	●	139-241	MLE1	●	136
MER18R	●	137	MG9	●	139-241	MLE2	●	136
MER19R	●	137	MGN1R	●	131-240	MLM1	● ▲	141
MER1R	● ▲	136	MGN1RP	●	131-240	MLM15	●	141-241
MER2	● ▲ U	136	MH1	●	139-156	MLM1R	▲	141
MER20R	●	137	MH1R	●	139-156	MLM2	▲	141
MER21R	●	137	MH2	●	139-149-156	MLM3R	▲	141
MER22T	◆	137	MH2R	●	139-149-156	MLM4R	▲	141
MER23	● ▲ U	137	MH3	●	139	MLM5	■	141-241
MER24	● ▲	136	MH4	●	139-156	MLM6R	▲	141
MER25T	◆	137	MH4R	●	139-156	MLM7R	▲	141
MER26T	◆	137	MH5	●	139	MLM9	●	122-239
MER27	● ▲	136	MH5R	● ▲	139	MLN1	●	139
MER29	●	136	MI1	● ▲	142	MLN3	●	139
MER31	●	137	MI1R	● ▲	142	MN1	● ▲	141
MER32	●	137	MI2	●	142	MN2	● ▲	141
MER33R	● ▲	138	MI2R	●	142	MN2R	●	141

● Brass  
Ottone  
Messing  
Laiton  
Latón  
Latão

▲ Steel  
Acciaio  
Stahl  
Acier  
Acero  
Aço

■ Nickel silver  
Alpaca  
Neusilber  
Maillechort  
Alpaca  
Alpaca

◆ Iron  
Ferro  
Eisen  
Fer  
Hierro  
Ferro

C Available in Color  
Disponibile in Color  
Lieferbar in Color  
Disponibile en Color  
Disponibile en Color  
Disponível em Color

U Available in Ultralite  
Disponibile in Ultralite  
Lieferbar in Ultralite  
Disponibile en Ultralite  
Disponibile en Ultralite  
Disponível em Ultralite

S Available in Silky  
Disponibile in Silky  
Lieferbar in Silky  
Disponibile en Silky  
Disponibile en Silky  
Disponível em Silky

REF.		PAGE	REF.		PAGE	REF.		PAGE
MN3	●	141	MS23	●	131-240	MTK4P	■	144-242
MN3R	●▲	141	MS24	▲	131	MTK4RP	●■	144-242
MN4	●▲	142	MS3	●▲	131	MTK4RPX	●■	144-242
MN4R	●▲	142	MS3R	●▲	131	MTK5	●▲U	143
MN5	●	142	MS4R	●▲	131	MTK5R	●▲U	143
MN5R	●▲	142	MS5R	●▲	131	MTK7R	●	144-242
MN6	●	142	MS6	●▲	131	MTK7RP	■	144-242
MN6R	●	142	MS7	●▲	131	MTK8R	●	144-242
MN7	●▲	141	MS8	●▲	131	MTK8RP	■	144-242
MN7R	●▲	141	MS9R	●▲	131	MTK9RP	●■	144-242
MN8	●▲	141	MSC1	▲	142	MTL1	●	143-241
MN8R	●▲	141	MSF1	▲	143	MTS1	▲	142
MN9	●▲	141	MSL1	●	132-240	MTS1R	▲	142
MN9R	●▲	141	MSL2	●	132-240	MTT1R	●	143
MO1RP	●	141-241	MSL3	●	132-240	MTT2R	●	143
MOD1	●▲	141	MSL4R	●	132-240	MTY1	●▲	140
MON1	●▲	141	MSL5R	●	132-240	MTY2	▲	140
MON1R	●▲	141	MST1	▲	142	MTZ1	●▲	117
MP101	●	143	MSV1	●▲	143	MU401	◆	270
MP102	●	143	MSV1R	●▲	143	MU402	◆	270
MP103	●▲	143	MSV2	▲	143	MU403	◆	270
MP104	●	143	MSV2R	▲	143	MU404	◆	270
MP105	●	143	MTA1R	▲G	138	MUL1	●U	143
MP228	●▲	143	MTA2	●	138-241	MUL2	●	143
MP229	●	143	MTA3R	▲	138	MX1	▲	138
MP230	●▲	143	MTA4	●	138-241	MX5	▲	138
MP231	●▲	143	MTK1	●■	144-241	MXU1R	▲	133
MR1	●	131	MTK10R	●	144-242	MXU2	▲	133
MS1	●▲U	131	MTK10RP	■	144-242	<b>N</b>		
MS10	●▲	131	MTK11	●	144-242	NAB1	●▲U	145
MS11	●▲	131	MTK11R	●U	144-242	NAB1R	●▲	145
MS11R	●▲	131	MTK12R	■	144-242	NAB2	●▲	145
MS12	●▲	131	MTK12RP	■	144-242	NAB3R	●▲	145
MS13R	●▲	131	MTK13R	●	144-242	NAB4	●▲U	145
MS14	●▲	131	MTK13RAP	●	144-242	NAB5	●	145
MS16	●	131	MTK14RP	●	144-242	NAB6	●	145
MS17	●▲	131	MTK15R	●	144-242	NCR1	●▲	145
MS19	●▲	131	MTK15RAP	●	144-242	NCR11R	●	145
MS2	●▲U	131	MTK16	■	144-242	NCR12	●	145
MS20P	●	132-240	MTK2	●	144-241	NCR13	●	145
MS21AP	●	132	MTK2P	■	144-241	NCR19	●	145
MS22	●	131-240	MTK3P	■	144-241			

● Brass  
Ottone  
Messing  
Laiton  
Latón  
Latão

▲ Steel  
Acciaio  
Stahl  
Acier  
Acero  
Aço

■ Nickel silver  
Alpacca  
Neusilber  
Maillechort  
Alpaca  
Alpaca

◆ Iron  
Ferro  
Eisen  
Fer  
Hierro  
Ferro

G Available in Color  
Disponibile in Color  
Lieferbar in Color  
Disponibile en Color  
Disponibile en Color  
Disponível em Color

U Available in Ultralite  
Disponibile in Ultralite  
Lieferbar in Ultralite  
Disponibile en Ultralite  
Disponibile en Ultralite  
Disponível em Ultralite

⊞ Available in Silky  
Disponibile in Silky  
Lieferbar in Silky  
Disponibile en Silky  
Disponibile en Silky  
Disponível em Silky

REF.		PAGE
NCR1R	●	145
NCR2	● ▲	145
NCR3	● ▲	145
NCR4	● U	145
NCR6	● ▲	145
NEC1	▲	145
NF1	● ▲	145
NF1R	● ▲	145
NK1	●	145
NK2	●	145
NK3	●	145
NME1R	▲	146
NME2R	▲	146
NME3	▲	146
NME4R	▲	146
NN1	●	146
NP1R	● ▲	146
NR1R	▲	145
<b>O</b>		
OA1	● ▲	148
OA1R	● ▲	148
OA2	● ▲	148
OA2R	●	148
OA3	●	148
OA3R	● ▲	148
OAL1	● ▲	146
OAL1R	● ▲	146
OAL2	●	146
OAL2R	● ▲	146
OAL3	●	146
OAL3R	● ▲	146
OAL4	● ▲	146
OAL4R	● ▲	146
OB1	●	146
OC074	● ▲ U C S	149
OC075	●	149
OC1	●	149
OC1R	● ▲	149
OC2	● ▲	149
OC236	● ▲	149
OC237	●	149

REF.		PAGE
OC238	● ▲	149
OC239	● ▲	149
OC2R	● ▲	149
OC3	●	149-242
OC4	●	149-242
OC5	●	149
OC6	●	149-242
OF4	● ▲	147
OJ1	● ▲	147
OJ10R	▲	147
OJ11	▲	147
OJ12R	● ▲	147
OJ13R	▲	147
OJ14	■	147-242
OJ15RP	▲	147
OJ16R	▲	147
OJ17R	▲	147
OJ18	●	147-242
OJ1R	● ▲	147
OJ2	● ▲	147
OJ3R	● ▲	147
OJ4	▲	147
OJ4R	● ▲ U	147
OJ5R	● ▲	147
OJ6R	● ▲	147
OJ7R	▲	147
OJ8R	▲	147
OJ9	▲	147
OL1	●	148
OL1R	▲	148
OL2	● ▲	148
OL2R	● ▲	148
OL3	● ▲	148
OL3R	● ▲	148
OL4	● ▲	148
OL4R	● ▲	148
OL5	● ▲	148
OL5R	● ▲	148
OL6	● ▲	148
OL6R	● ▲	148
OLT1	● ▲	148
OLT2	●	148

REF.		PAGE
OLT3	●	148
OLT4	▲	148
OLT5	▲	148
OLT6R	● ▲	148
OLT7	● ▲	148
OLT8R	● ▲	148
OMR1R	● ▲	150
ON1	▲	150
ON1R	▲	150
OR1R	▲	150
ORA1	▲	150
ORA2	▲	150
ORO1	● ▲	150
ORO2	●	150
OV1	● ▲	149
OV1R	● ▲	149
OV2	▲	149
OV2R	● ▲	149
OV3	● ▲	149
OV3R	●	149
<b>P</b>		
PA1	●	153
PA1R	●	153
PA2	●	153
PA2R	● ▲	153
PAC1R	● U	150
PAC2R	●	150
PAC3R	●	150
PAC4	●	150
PAD1	▲	152
PAD2	▲	152
PAD3	▲	152
PC1	● ▲	153
PC10	●	153
PC10R	● ▲	153
PC11	● ▲	154
PC11R	● ▲	154
PC12T	●	154-169
PC13	▲	112-153
PC14	●	153
PC15T	●	154-169

● Brass  
Ottone  
Messing  
Laiton  
Latón  
Latão

▲ Steel  
Acciaio  
Stahl  
Acier  
Acero  
Aço

■ Nickel silver  
Alpaca  
Neusilber  
Maillechort  
Alpaca  
Alpaca

◆ Iron  
Ferro  
Eisen  
Fer  
Hierro  
Ferro

Ⓒ Available in Color  
Disponibile in Color  
Lieferbar in Color  
Disponibile en Color  
Disponibile en Color  
Disponível em Color

Ⓒ Available in Ultralite  
Disponibile in Ultralite  
Lieferbar in Ultralite  
Disponibile en Ultralite  
Disponibile en Ultralite  
Disponível em Ultralite

Ⓒ Available in Silky  
Disponibile in Silky  
Lieferbar in Silky  
Disponibile en Silky  
Disponibile en Silky  
Disponível em Silky

Articles and materials general index / Índice Generale articoli e materiali / Allgemeines Artikel- und Materialverzeichnis / Table des matières des articles et des matériaux / Índice general de los artículos y de los materiales / Índice geral dos artigos e dos materiais

REF.		PAGE	REF.		PAGE	REF.		PAGE
PC15TP	●	154	PDO21	●	151	PF4	● ▲	157
PC18R	● ▲	153	PDO21R	●	151	PF4R	● ▲	157
PC1R	●	153	PDO22	●	151	PF5	● U	157
PC2	● ▲	153	PDO22R	●	151	PF5S	● U	157
PC20	●	153	PDO23	●	151	PF6	● ▲	157
PC26	●	153	PDO9	●	151	PF6R	● ▲	157
PC27	●	153	PDO9R	● U	151	PF7	● ▲ U	156
PC28	●	154	PF070	● ▲	157	PF7S	● ▲ U	156
PC2R	● ▲	153	PF071	● ▲	157	PF8	● ▲	156
PC3	● ▲	153	PF072	● ▲	157	PF8R	●	156
PC31R	●	153	PF073	● ▲	157	PF9	●	157
PC32R	● ▲	153	PF092	● ▲ U C S	157	PF9R	●	157
PC33	●	153	PF092S	● ▲ U C S	157	PG1	● ▲	154
PC33R	●	153	PF1	● ▲ G	157	PG1R	● ▲	154
PC3R	● ▲	153	PF11	● ▲	156	PHF10R	▲	155
PC4	●	153	PF11R	● ▲	156	PHF11R	▲	155
PC4R	●	153	PF12	● ▲	146-157	PHF12	▲	155
PC5	▲	154	PF13R	● ▲	158	PHF15	▲	155
PC5R	▲	154	PF14	▲	158	PHF16R	▲	155
PC6	● ▲	153	PF15	● ▲	157	PHF17	▲	155
PC7	●	153	PF16R	▲	157	PHF18R	● ▲	155
PC8	● ▲	153	PF18	●	158-243	PHF19	● ▲	155
PC9	● ▲	154	PF19	●	157	PHF1R	▲	155
PD1	●	158	PF1P	● ▲	157	PHF22R	▲ ■	155
PDO10R	●	151	PF1R	● ▲	157	PHF23	▲	155
PDO11	● U	151	PF1RP	●	157	PHF26	●	155
PDO12	●	151	PF2	● ▲ U C	157	PHF26R	●	155
PDO12R	●	151	PF20	●	158-243	PHF27	● ▲	155
PDO13	●	151	PF208	● ▲ U	157	PHF27R	●	155
PDO13R	●	151	PF209	● U	157	PHF28R	▲	155
PDO14	●	151	PF21	●	158-243	PHF29	▲	155
PDO14R	●	151	PF210	● ▲ U	157	PHF2R	▲	155
PDO17	●	151	PF211	● ▲ U	157	PHF32	▲	155
PDO17R	●	151	PF212	● ▲ U	157	PHF34	●	155
PDO18	● U	151	PF213	● ▲ U	157	PHF37	▲	155
PDO18R	● U	151	PF214	▲	156	PHF4R	▲	155
PDO19	●	151	PF215	●	156	PHF5	▲	155
PDO19R	●	151	PF215R	●	156	PHF6	▲	155
PDO1R	● U	151	PF22	●	158-243	PHF7R	▲	155
PDO2	● U	151	PF2S	● ▲ U	157	PHF8R	▲	155
PDO20	●	151	PF3	● ▲	156	PHF9R	▲	155
PDO20R	●	151	PF3R	● ▲	156	PIC1	● ■	155-243

● Brass  
Ottone  
Messing  
Laiton  
Latón  
Latão

▲ Steel  
Acciaio  
Stahl  
Acier  
Acero  
Aço

■ Nickel silver  
Alpacca  
Neusilber  
Maillechort  
Alpaca  
Alpaca

◆ Iron  
Ferro  
Eisen  
Fer  
Hierro  
Ferro

Ⓒ Available in Color  
Disponibile in Color  
Lieferbar in Color  
Disponibile en Color  
Disponibile en Color  
Disponível em Color

Ⓢ Available in Ultralite  
Disponibile in Ultralite  
Lieferbar in Ultralite  
Disponibile en Ultralite  
Disponibile en Ultralite  
Disponível em Ultralite

Ⓣ Available in Silky  
Disponibile in Silky  
Lieferbar in Silky  
Disponibile en Silky  
Disponibile en Silky  
Disponível em Silky

REF.		PAGE	REF.		PAGE	REF.		PAGE
PIC2	●	155-243	RC14R	●	55-229	RIQ4R	● ▲	99
PL1	● ▲	155	RC15R	●	55-229	RIQ5	● ▲	99
PM1	●	158	RC16R	●	55-229	RIQ5R	● ▲	99
PN1	●	154-243	RC17R	●	55-229	RIQ6S	● ▲	99
PN2	●	154-243	RC1R	● ▲	54	RIQ7	● ▲	99
PRI3R	● ▲	158	RC3R	● ▲ U	54	RIQ7R	▲	99
PRL1	●	158	RC4	● ▲	54	RIQ8	● ▲	99
PS1	▲	155	RC5	● ▲	54	RIQ8R	● ▲	99
PT1	● ▲	146-149-156	RC5R	▲	54	RIQ9	▲	99
PT1R	● ▲	146-149-156	RC6	●	54	RIQ9R	▲ U	99
PT2	● ▲	156	RC6R	●	54	RL1	◆	269
PT4R	●	156-243	RC7R	▲	54	RM1A	●	160
PT5RP	●	156-243	RC8R	●	55-229	RM1RA	●	160
PT6RP	●	156-243	RC9R	●	54-229	RM2A	●	160
PT7RAP	●	156-243	RD1	●	160	RM2RA	●	160
PTZ1R	▲	155	RD2	● ▲	160	RO13	▲	161
PZ1	● ▲ U	152	RDC1	●	159	RO14	▲	161
PZ14	●	152	REL1R	● ▲	159	RO15	● ▲	161
PZ15	● U	153	REL2	●	159	RO15R	▲	161
PZ17	●	152	REL3	● ▲	159	RO20	● ▲	161
PZ18R	●	152	REN1	● ▲	159	RO20R	● ▲	161
PZ19	●	153	REN1R	● ▲	159	RO21	▲	162
PZ2	● ▲ U	152	REN2	▲	159	RO21R	▲	162
PZ20R	●	153	REN2R	▲	159	RO22	● ▲	161
PZ3	● ▲ U	152	REN3R	▲	159	RO22R	● ▲	161
PZ4	● ▲	152	REN4R	▲	159	RO23	● ▲	161
PZ5	● ▲ U	152	REN5	▲	159	RO23R	● ▲	161
PZ6	● ▲ U	152	REN6	▲	159	RO24	● ▲	161
PZ7	● U	152	REN6R	▲	159	RO24R	▲	161
PZ8	● U	152	RG1	● ▲	158	RO25	● ▲	161
PZ9	● U	152	RGA1	▲	160	RO25R	● ▲	161
<b>R</b>			RGM1	● ▲	160	RO26	● ▲	161
RA1	● ▲	160	RGM1R	● ▲	160	RO27	● ▲	161
RA1R	● ▲	160	RIC1	▲	160	RO27R	● ▲	161
RBT1R	●	158	RIQ1	● ▲	99	RO30	▲	161
RBT2	● U	158	RIQ10R	▲	99	RO30R	▲	161
RC10R	●	54-229	RIQ11	▲	99	RO34	▲	162
RC11	●	54-229	RIQ11R	▲	99	RO34R	▲	162
RC11R	●	54-229	RIQ1R	● ▲ U	99	RO37	▲	161
RC12R	▲	54	RIQ2	● ▲	99	RO37R	● ▲	161
RC13R	▲	54	RIQ3	▲	99	RO38	● ▲	161
			RIQ4	● ▲	99	RO38R	▲	161

● Brass  
Ottone  
Messing  
Laiton  
Latón  
Latão

▲ Steel  
Acciaio  
Stahl  
Acier  
Acero  
Aço

■ Nickel silver  
Alpaca  
Neusilber  
Maillechort  
Alpaca  
Alpaca

◆ Iron  
Ferro  
Eisen  
Fer  
Hierro  
Ferro

Ⓒ Available in Color  
Disponibile in Color  
Lieferbar in Color  
Disponibile en Color  
Disponibile en Color  
Disponível em Color

Ⓒ Available in Ultralite  
Disponibile in Ultralite  
Lieferbar in Ultralite  
Disponibile en Ultralite  
Disponibile en Ultralite  
Disponível em Ultralite

Ⓒ Available in Silky  
Disponibile in Silky  
Lieferbar in Silky  
Disponibile en Silky  
Disponibile en Silky  
Disponível em Silky



REF.		PAGE	REF.		PAGE	REF.		PAGE
RO4	●▲U	161	RU1R	●▲	162	<b>S</b>		
RO41	●▲UCS	161-199	RU2	▲	162			
RO42	●▲	161	RU20	●	162	SA1	▲	163
RO42R	●▲	161	RU21	●	162	SA1R	▲	163
RO43R	●▲	161	RU22R	●	162	SA2	▲	163
RO44	▲	162	RU23R	●	162	SA2R	●▲	163
RO44R	▲	162	RU24R	●	162	SA3	▲	163
RO45	●▲	161	RU25	●	162	SA3R	▲	163
RO46R	●▲	161	RU25R	●	162	SA4	▲	163
RO47	▲	161	RU26	●	162	SA5	▲	163
RO47R	▲	161	RU27	●	162	SA5R	▲	163
RO48R	●▲	161	RU28	▲	162	SAM1	●U	174
RO49	▲	162	RU29R	▲	162	SAM10	●	175
RO4R	●▲	161	RU2R	▲	162	SAM11R	●	175
RO50	▲	161	RU3	●▲	162	SAM12R	●	175
RO51	▲	162	RU30	▲	162	SAM13	●	174
RO53R	▲	162	RU3R	●▲	162	SAM13R	●	174
RO67	●	161	RU4	●▲	162	SAM14	●	174
RO67R	●	161	RU4R	●▲	162	SAM15R	●	174
RO68	●	161	RU5	▲	162	SAM16R	●	175
RO68R	●	161	RU5R	▲	162	SAM1R	●U	174
RO69	▲	161	RU6	▲	162	SAM2	●U	175
RO7	●▲	161	RU7	●▲	162	SAM2R	●U	175
RO77	▲	161	RU8R	●▲	162	SAM3R	●U	175
RO7R	●▲	161	RU9R	●▲	162	SAM4	●	174
RO8	●▲UCS	161	RUS1	▲	114	SAM6	●	175
RO84	▲	162	RUS1R	▲	114	SAM8	●	175
RO85	▲	161	RUS2	▲	114	SAM9R	●	174
RO8R	●▲	161	RUS3R	▲	67	SAN1	●▲	164
RO9	●▲	161	RUS4	▲	163	SAN1R	●▲	164
RO9R	▲	161	RUS5	▲	163	SAR1	▲■	165
ROY1	▲	162	RUS6	▲	163	SAR1031	●	269
RSS3	●	162-244	RV1	●	160	SAR1032	●	269
RU1	●▲UC	162	RW25	●▲	163	SAR17	▲	164
RU10R	●▲	162	RW7R	●	163	SAR17R	●▲	164
RU11R	●▲	162	RW8R	●	163	SAR2	●▲■	165
RU12	●▲	162	RX1	●▲	160	SAR21	●	164
RU13	▲	162	RX2	●▲	160	SAR21R	▲	164
RU14	●▲UC	162	RZA1	▲	160	SAR22R	▲	164
RU15R	▲	162	RZA2	▲	160	SAR3	●U	164
RU16	▲	162	RZA3	▲	160	SAR3R	●▲U	164
RU19	▲	162				SAR4R	▲	165

● Brass  
Ottone  
Messing  
Laiton  
Latón  
Latão

▲ Steel  
Acciaio  
Stahl  
Acier  
Acero  
Aço

■ Nickel silver  
Alpacca  
Neusilber  
Maillechort  
Alpaca  
Alpaca

◆ Iron  
Ferro  
Eisen  
Fer  
Hierro  
Ferro

Ⓒ Available in Color  
Disponibile in Color  
Lieferbar in Color  
Disponibile en Color  
Disponibile en Color  
Disponível em Color

Ⓘ Available in Ultralite  
Disponibile in Ultralite  
Lieferbar in Ultralite  
Disponibile en Ultralite  
Disponibile en Ultralite  
Disponível em Ultralite

Ⓔ Available in Silky  
Disponibile in Silky  
Lieferbar in Silky  
Disponibile en Silky  
Disponibile en Silky  
Disponível em Silky

REF.		PAGE	REF.		PAGE	REF.		PAGE
SAR8	●	164	SGM1	▲	169	SJ1R	▲	171
SB1	● ▲	163	SH1	● ◆	165	SKR1	▲	167
SC1	▲	167	SH10	● ▲ ■	166	SL1	● ▲ U	167
SC2	● ▲	167	SH11	● ▲ ■	166	SLC1TP	●	154-169
SCH1R	●	163-244	SH12	▲	166	SLC2TP	●	154-169
SCM1R	●	167-244	SH12R	●	165	SLC3T	●	169
SCM2	●	167-244	SH13	●	166	SLR1	▲	172
SCM3RP	●	167-244	SH14	● ▲	166	SLX1	●	172
SCM4	●	167	SH15	▲	166	SM1	● ▲ U G	38-96-170
SCT1R	●	167-244	SH16	● ▲ U	166	SM10R	▲	170
SCU1	Zama	167-244	SH17	●	166	SM11	▲	170
SD1	● ▲	169	SH18	●	166	SM12	▲	170
SD2	▲	169	SH19	●	166	SM13	▲	170
SD3T	●	169	SH2	● ◆	165	SM14R	▲	170
SDT1R	●	178-245	SH20	● U	166	SM15	▲	170
SE1	▲	168	SH21	●	166	SM16	● ▲	170
SE1R	▲	168	SH22	● ▲	166	SM1R	● ▲ U	96-170
SE3	▲	168	SH23	● ▲ ■	166	SM2	● ▲	170
SE3R	▲	168	SH24	●	166	SM3	● ▲	170
SE5	● ▲	168	SH27	● ▲	165	SM4	● ▲	170
SE5R	● ▲	168	SH3	● ▲ ■ U	166	SM5	● ▲	170
SE7	▲	168	SH4	● ▲ U	166	SM6	▲	170
SE7R	● ▲	168	SH5	● ▲ ■ U	166	SM8	● ▲	170
SE8	▲	168	SH5R	▲	165	SM9	▲	170
SEA4	●	139-167	SH6	▲ ■	166	SM9R	▲	170
SEA4R	●	139-167	SH7	● ■ U	166	SMA1	▲	163
SEA5	● ▲	150-167	SH8	● ▲	166	SN1	▲	172
SEA5R	● ▲	150-167	SH9	● ▲	166	SN1R	● ▲	172
SEA7	● ▲	150-167	SHT1	▲	168	SN2	● ▲	172
SEA8	● ▲	150-167	SHW1	▲	168	SN2R	● ▲ U	172
SEB1	● ■	166-244	SHW2	● ▲	168	SN3R	● ▲	171
SEB2	■	166-244	SI1	● ▲	172	SN4R	▲	171
SEB3	■	166-244	SI1R	▲ U	172	SN5R	● ▲	172
SEI10	●	3	SI2R	● ▲	172	SNC1	▲	172
SEM1	▲	168	SI3R	● ▲	172	SNC2	▲	172
SF1	● ◆	163	SI4	▲	172	SNC2R	▲	172
SF2	●	163	SI4R	● ▲ U	172	SNC3	▲	172
SFB1R	●	168	SI5R	▲	172	SNW1	●	164
SFD1R	▲	175	SI6R	● ▲	172	SNW2	●	164
SG1	▲	54-168	SIA1R	▲	169	SNW3	●	164
SG808	● ▲ U	54-168	SIL1	▲	169	SO10R	▲	174
SG808R	● ▲	54-168	SIL1R	▲	169	SO11R	▲	174

● Brass  
Ottone  
Messing  
Laiton  
Latón  
Latão

▲ Steel  
Acciaio  
Stahl  
Acier  
Acero  
Aço

■ Nickel silver  
Alpacca  
Neusilber  
Maillechort  
Alpaca  
Alpaca

◆ Iron  
Ferro  
Eisen  
Fer  
Hierro  
Ferro

Ⓒ Available in Color  
Disponibile in Color  
Lieferbar in Color  
Disponibile en Color  
Disponível em Color

Ⓒ Available in Ultralite  
Disponibile in Ultralite  
Lieferbar in Ultralite  
Disponibile en Ultralite  
Disponível em Ultralite

Ⓒ Available in Silky  
Disponibile in Silky  
Lieferbar in Silky  
Disponibile en Silky  
Disponível em Silky

REF.		PAGE	REF.		PAGE	REF.		PAGE
SO4	▲	173	SS13	●▲U	171	STL1R	▲	176
SO5	▲	173	SS14	▲	170	STL2R	▲	176
SO6	▲	173	SS14R	▲	170	STL3	▲	176
SO7	▲	173	SS1R	●▲	170	STN1	●▲	177
SO8R	▲	173	SS3	●▲	170	STN1R	●▲	177
SO9	▲	173	SS3R	●▲	170	STR3	▲	176
SOF1	●▲	172	SS4	●▲	171	STR4	●▲	176
SOF1R	●▲	172	SS6	●▲	170	STR4R	●▲	176
SOP1	●U	173	SS7	●▲	170	STR5	▲	176
SOP10	●	173	SS7R	●▲	170	STR5R	●▲	176
SOP11	●	173	SS8	●▲	171	STR6	●▲	176
SOP12	●	173	SS9	●▲U	170	STS1	▲	177
SOP13R	●	173	SSO1	▲	171	STS11	▲	177
SOP14RP	●	173	SSO2	▲	171	STS12	■	177-245
SOP15R	●	173	SSP1	▲	171	STS13	●	177-245
SOP16R	●	173	SSP1R	●▲	171	STS1R	▲	177
SOP17R	●	173	SSP2	●▲	171	STS2	▲	177
SOP18R	●	173	SSP4	▲	171	STS2R	▲	177
SOP2	●	173	SSP4R	▲	171	STS3	▲	177
SPR1	■	174-245	SSP5	●▲	171	STS4	▲	177
SPR2	●■	174-245	SSP6	▲	171	STS5	●	177-245
SPU1R	●	178	ST1	●▲	166	STS6	●▲S	177-245
SQ1	●▲	174	STA1	▲	175	STS9	●■	177-245
SQ2	▲	174	STA10	●	175	STU1	▲U	165
SQ3R	▲	174	STA10R	●▲	175	STU3	▲	165
SQ4R	▲	174	STA11R	▲	176	STU6R	●	165-244
SQ5	▲	174	STA1R	▲	175	STY1P	▲	176
SQ6R	▲	174	STA2	●▲	175	SU1R	●▲	178
SR10R	●▲	178	STA2R	●▲	175	SV1	●▲	178
SR11R	●▲	178	STA3	●▲	175	SV1R	●▲	178
SR2	▲	178	STA3R	●▲	175	SV2	▲	178
SR2R	▲	178	STA4	●▲U	176	SV2R	▲	178
SR4	▲	178	STA4R	●▲U	176	SV3	▲	177
SR6	▲	178	STA5	●▲	176	SV3R	▲	177
SR7	▲	178	STA6	●▲	176	SV4	●▲	178
SR8	▲	178	STA6R	●▲	176	SV4R	●▲	178
SR9R	▲	178	STA7	▲	176	SV5	▲	178
SRT1	▲	164	STA8	▲	176	SV5R	●▲	178
SRT2	▲	164	STA8R	▲	176	SV6R	●▲	178
SS1	●	170	STA9R	▲	175	SV7	●▲	177
SS10	●▲U	170	STF1	●▲	177	SV8	▲	178
SS12	▲	170	STF1R	●▲	177	SV8R	▲	178

● Brass  
Ottone  
Messing  
Laiton  
Latón  
Latão

▲ Steel  
Acciaio  
Stahl  
Acier  
Acero  
Aço

■ Nickel silver  
Alpacca  
Neusilber  
Maillechort  
Alpaca  
Alpaca

◆ Iron  
Ferro  
Eisen  
Fer  
Hierro  
Ferro

Ⓒ Available in Color  
Disponibile in Color  
Lieferbar in Color  
Disponibile en Color  
Disponibile en Color  
Disponível em Color

Ⓘ Available in Ultralite  
Disponibile in Ultralite  
Lieferbar in Ultralite  
Disponibile en Ultralite  
Disponibile en Ultralite  
Disponível em Ultralite

Ⓔ Available in Silky  
Disponibile in Silky  
Lieferbar in Silky  
Disponibile en Silky  
Disponibile en Silky  
Disponível em Silky

REF.		PAGE	REF.		PAGE	REF.		PAGE
SVE1R	▲	165	TAR7	▲	180	TL1	●▲U	189
SVE2R	▲	165	TAR7R	▲	180	TL10	●▲	190
SVN1	●▲	169	TAR8	●▲	180	TL10R	●▲	190
SVN2	●	169	TAR8R	●▲	180	TL11	●▲U	190
SW1R	●▲	179	TAR9	●▲	179	TL11R	●▲U	190
SW2	●	179	TAR9R	●▲	179	TL12	▲	190
SW3	●▲	179	TC1	●	182	TL12R	▲	190
SWA1	●▲	169	TC1R	●▲	182	TL13	●▲	190
SWA10	●	168	TCL1	▲	181	TL14	●▲	190
SWA13R	■	168	TE1	●▲U	181	TL15	▲	190
SWA2R	●▲	169	TE16	●	181-246	TL15R	▲	190
SWA3R	●▲	169	TE19	●	181-246	TL16R	▲	189
SWA4R	●	169	TE1R	▲	181	TL1R	●▲U	189
SWA5R	●	169	TE2	●▲U☉☼	181	TL2	●▲U	189
SWA6R	●	169	TE2R	●▲	181	TL2R	●▲U	189
SWA7R	●▲	169	TE2X	●▲U	181	TL3	●▲U	189
SWA8	●▲U	169	TE3	●▲U	181	TL3R	●▲U	189
SWA9R	●▲	169	TE4	●■	181-246	TL4	●▲U	189
SWL1	●▲	176	TE4R	●■	181-246	TL4R	●▲U	189
SY1	●	171	TE5	●■	181-246	TL5	●▲	189
<b>T</b>			TE6	▲	181	TL5R	●▲	189
TAR1	●▲	180	TE7	●■U☉☼	182-246	TL6	●▲	189
TAR10	●	180	TE8XFA	▲	181	TL6R	●▲	189
TAR10R	●▲	180	TE9	●	182-246	TL7	●▲	189
TAR11	●	179	TEC1	■	180-245	TL7R	●▲	189
TAR11R	●▲	179	TEN1	●	180-245	TL8	●▲U	189
TAR16	●	179-245	TEN2R	▲	180	TL8R	●▲U	189
TAR16R	●	179-245	TFN1	▲	182	TL9	●▲	190
TAR1R	●▲	180	TFN2	▲	182	TL9R	●▲	190
TAR2	▲	180	TG1	●▲	182	TLC1R	●	182-246
TAR21	●	179-245	TGS1R	●	181-245	TLN1	▲	179
TAR26	●	179	THA1	▲	182	TM1RP	●	190-247
TAR2R	●▲	180	THR1	●	182-246	TN1	▲	182
TAR3	●▲	180	TI1	●	182	TN10	▲	183
TAR3R	●▲	180	TK1	●▲■	181	TN11R	▲	183
TAR4	●▲	179	TK1R	●▲	181	TN14	▲	183
TAR4R	●▲	179	TK2	●▲	181	TN16	▲	183
TAR5	●▲	179	TK2R	●▲■	181	TN16X	▲U	183
TAR5R	●▲	179	TK3	●▲	181	TN16XA	▲U	183
TAR6	▲	180	TK3R	●▲	181	TN19R	▲	183
TAR6R	▲	180	TK4	●▲	181	TN1R	●▲	182
			TK4R	●▲	181	TN2	▲U☉☼	182

● Brass  
Ottone  
Messing  
Laiton  
Latón  
Latão

▲ Steel  
Acciaio  
Stahl  
Acier  
Acero  
Aço

■ Nickel silver  
Alpacca  
Neusilber  
Maillechort  
Alpaca  
Alpaca

◆ Iron  
Ferro  
Eisen  
Fer  
Hierro  
Ferro

☉ Available in Color  
Disponibile in Color  
Lieferbar in Color  
Disponibile en Color  
Disponível em Color

U Available in Ultralite  
Disponibile in Ultralite  
Lieferbar in Ultralite  
Disponibile en Ultralite  
Disponível em Ultralite

☼ Available in Silky  
Disponibile in Silky  
Lieferbar in Silky  
Disponibile en Silky  
Disponível em Silky

REF.		PAGE	REF.		PAGE	REF.		PAGE
TN20	▲	183	TO19	●■	187	TO50RX6	●▲	185
TN20R	▲	183	TO1X	●▲UⓄⓈ	186	TO50RX7	●▲	185
TN23	▲	183	TO2	●	186	TO50RX9	●	185
TN2R	▲	182	TO20R	●■	187	TO50X1	●	185
TN31R	●	183	TO21	●▲■	187	TO50X10	●	185
TN32	●	183-246	TO22	●▲	184	TO50X11	●	185
TN35	▲	183	TO23	●	184	TO50X12	●	185
TN36	▲	183	TO24	▲	184	TO50X13	▲	185
TN36R	▲	183	TO25R	●▲	186	TO50X14	●	185
TN37R	▲	182	TO26	●▲	184	TO50X15	▲	185
TN39	●▲	183	TO27	●▲	187	TO50X16	●	185
TN4	●▲	183	TO28R	●▲	186	TO50X17	▲	185
TN4R	●▲	183	TO29	●▲U	184	TO50X18	●	185
TN5	●▲U	182	TO29X	●▲	186	TO50X2	●▲	185
TN50	●	183	TO3	●	186	TO50X3	●	185
TN51	●	183-246	TO30	▲	187	TO50X4	●▲	185
TN6R	●▲	183	TO30R	●▲Ⓢ	187	TO50X5	●▲	185
TN7	▲U	183	TO30RX	●▲Ⓞ	187	TO50X6	●▲	185
TN8R	●▲	182	TO30X	▲	187	TO50X7	●▲	185
TN9	▲	183	TO31R	●▲	186	TO50X8	●	185
TO1	●▲U	186	TO33	●▲	187	TO50X9	●▲	185
TO10	●▲	186	TO34	●▲	187	TO51RY1	▲	186
TO100	●	187	TO35	▲	186	TO51RY10	●	186
TO104	▲	187	TO36R	●	186	TO51RY11	●	186
TO105	▲	187	TO39R	▲	187	TO51RY12	●	186
TO106	▲	187	TO4	●▲	186	TO51RY13	●	186
TO107	▲	187	TO40	●▲	187	TO51RY14	●	186
TO108X	▲	187	TO41R	▲	186	TO51RY15	●	186
TO11	●	187	TO42R	●■	187	TO51RY16	●	186
TO111R	●	187	TO43	●	187	TO51RY17	●	186
TO114RX	●▲	186	TO44	▲	184	TO51RY18	●	186
TO12	●▲	184	TO45	■	187	TO51RY2	●	186
TO120RX	●▲	186	TO5	●▲	186	TO51RY3	●	186
TO124RX	▲	186	TO50RX13	●	185	TO51RY4	●	186
TO125X	▲	186	TO50RX14	●	185	TO51RY5	●	186
TO127	▲	187	TO50RX15	●	185	TO51RY6	●	186
TO13	●▲	187	TO50RX16	●	185	TO51RY7	●	186
TO14	●▲	187	TO50RX17	●	185	TO51RY8	●	186
TO15	●	186	TO50RX18	●	185	TO51RY9	●	186
TO16	●▲	186	TO50RX2	●▲	185	TO51Y1	●▲	186
TO17	●▲	186	TO50RX4	●▲	185	TO51Y10	●	186
TO18	●■	187	TO50RX5	▲	185	TO51Y11	●	186

● Brass  
Ottone  
Messing  
Laiton  
Latón  
Latão

▲ Steel  
Acciaio  
Stahl  
Acier  
Acero  
Aço

■ Nickel silver  
Alpacca  
Neusilber  
Maillechort  
Alpaca  
Alpaca

◆ Iron  
Ferro  
Eisen  
Fer  
Hierro  
Ferro

Ⓞ Available in Color  
Disponibile in Color  
Lieferbar in Color  
Disponibile en Color  
Disponibile en Color  
Disponível em Color

U Available in Ultralite  
Disponibile in Ultralite  
Lieferbar in Ultralite  
Disponibile en Ultralite  
Disponibile en Ultralite  
Disponível em Ultralite

Ⓢ Available in Silky  
Disponibile in Silky  
Lieferbar in Silky  
Disponibile en Silky  
Disponibile en Silky  
Disponível em Silky

REF.		PAGE	REF.		PAGE	REF.		PAGE
TO51Y12	●	186	TO64	■	187	TO8X9	●	185
TO51Y13	●	186	TO65	■	187	TO91	●	187
TO51Y14	●	186	TO66	▲	184	TO92R	●	184
TO51Y15	●	186	TO7	● ▲	186	TO9RY1	● ▲	185
TO51Y16	●	186	TO75R	● ▲	186	TO9RY10	● ▲	185
TO51Y17	●	186	TO81R	▲	187	TO9RY11	● ▲	185
TO51Y18	● ▲	186	TO82R	● ▲	186	TO9RY12	● ▲	185
TO51Y2	●	186	TO8RX1	● ▲	185	TO9RY13	● ▲	185
TO51Y3	●	186	TO8RX10	●	185	TO9RY14	● ▲	185
TO51Y4	●	186	TO8RX11	●	185	TO9RY15	● ▲	185
TO51Y5	● ▲	186	TO8RX12	●	185	TO9RY16	● ▲	185
TO51Y6	● ▲	186	TO8RX13	●	185	TO9RY17	● ▲	185
TO51Y7	●	186	TO8RX14	● ▲	185	TO9RY18	● ▲	185
TO51Y8	●	186	TO8RX15	● ▲	185	TO9RY2	● ▲	185
TO51Y9	▲	186	TO8RX16	● ▲	185	TO9RY3	● ▲	185
TO52	▲ ■	187	TO8RX17	● ▲	185	TO9RY4	● ▲	185
TO53	●	187	TO8RX18	● ▲	185	TO9RY5	● ▲	185
TO54-1	●	186	TO8RX2	●	185	TO9RY6	● ▲	185
TO54-13	●	186	TO8RX3	● ▲	185	TO9RY7	● ▲	185
TO54-14	●	186	TO8RX4	● ▲	185	TO9RY8	● ▲	185
TO54-16	●	186	TO8RX5	●	185	TO9RY9	● ▲	185
TO54-17	●	186	TO8RX6	●	185	TO9Y1	● ▲	185
TO54-18	●	186	TO8RX7	● ▲	185	TO9Y10	●	185
TO54-19	●	186	TO8RX8	● ▲	185	TO9Y11	● ▲	185
TO54-2	●	186	TO8RX9	● ▲	185	TO9Y12	● ▲	185
TO54-20	●	186	TO8X1	● ▲	185	TO9Y13	● ▲	185
TO54-21	●	186	TO8X10	●	185	TO9Y14	● ▲	185
TO54-23	●	186	TO8X11	● ▲	185	TO9Y15	● ▲	185
TO54-24	●	186	TO8X12	●	185	TO9Y16	● ▲	185
TO54-3	●	186	TO8X13	● ▲	185	TO9Y17	● ▲	185
TO54-4	●	186	TO8X14	● ▲	185	TO9Y18	● ▲	185
TO54-5	●	186	TO8X15	● ▲	185	TO9Y2	● ▲	185
TO54-6	●	186	TO8X16	● ▲	185	TO9Y3	● ▲	185
TO54-7	●	186	TO8X17	● ▲	185	TO9Y4	●	185
TO54-8	●	186	TO8X18	● ▲	185	TO9Y5	● ▲	185
TO55	■	187	TO8X2	● ▲	185	TO9Y6	●	185
TO57	● ▲ ■	187	TO8X3	● ▲	185	TO9Y7	● ▲	185
TO58	●	187	TO8X4	● ▲	185	TO9Y8	● ▲	185
TO59	■	187	TO8X5	● ▲	185	TO9Y9	● ▲	185
TO6	● ▲	186	TO8X6	●	185	TOL1	▲	191
TO60	■	187	TO8X7	● ▲	185	TOL2	▲	191
TO61	■	187	TO8X8	● ▲	185	TOP1R	● ▲	6-187

● Brass  
Ottone  
Messing  
Laiton  
Latón  
Latão

▲ Steel  
Acciaio  
Stahl  
Acier  
Acero  
Aço

■ Nickel silver  
Alpacca  
Neusilber  
Maillechort  
Alpaca  
Alpaca

◆ Iron  
Ferro  
Eisen  
Fer  
Hierro  
Ferro

Ⓒ Available in Color  
Disponibile in Color  
Lieferbar in Color  
Disponibile en Color  
Disponibile en Color  
Disponível em Color

Ⓒ Available in Ultralite  
Disponibile in Ultralite  
Lieferbar in Ultralite  
Disponibile en Ultralite  
Disponibile en Ultralite  
Disponível em Ultralite

Ⓒ Available in Silky  
Disponibile in Silky  
Lieferbar in Silky  
Disponibile en Silky  
Disponibile en Silky  
Disponível em Silky

REF.		PAGE	REF.		PAGE	REF.		PAGE
TOP1RX	▲ U S	187	TRF6R	●	3	<b>U</b>		
TOU1R	●	187	TRK10	▲	188	UAP1	▲	191
TOU2R	● ▲	187	TRK10R	▲	188	UAP2	▲	191
TOU3R	●	187	TRK11DP	■	189	UB1R	● ▲	197
TOZ13	▲	184	TRK13EP	●	189	UB2R	● ▲ U	197
TOZ14	▲	184	TRK1P	●	189	UB3	● ■	197-247
TOZ2	▲	184	TRK4CP	●	188	UB5	●	197
TOZ6	▲	184	TRK5P	●	189	UC1	▲	192
TP1	● ▲	31-179	TRK6EP	●	189	UC1R	▲ U	192
TP1R	● ▲	179	TRK6P	●	189	UC2	▲	192
TP2	● ▲	179	TRK7P	● ▲	189	UC3RP	● ■	192-247
TP2R	● ▲	179	TRK8DP	■	189	UC4R	●	192-247
TP3	▲	179	TRK9	▲	188	UC5R	●	192-247
TP3R	▲	179	TRK9R	▲	188	UC6R	▲ U	192
TR1	● ■	190	TRM1R	●	3-225	UC8R	● S	192-247
TR10	●	190	TRM2	▲	3	UE2R	●	192
TR10R	●	190	TRM3	▲	3	UE3R	● U	192
TR11R	●	190	TRS1R	▲	191	UE4R	● U	192
TR12	●	190	TRU1R	●	188	UE5R	●	192
TR13R	●	190	TS1	▲	188	UL046	● ▲ U	194
TR14	●	191	TS2	▲	188	UL047	▲ U	194
TR15	●	191	TS3	▲	188	UL048	● ▲ U	195
TR16	▲	190	TS4	▲	188	UL049	● ▲ U	195
TR17R	● ▲	190	TS5	▲	188	UL050	● ▲ U C S	194
TR18R	● ▲	190	TTL1	●	183	UL050B	● ▲	195
TR19R	● ▲	190	TTL2	●	184	UL050C	● ▲ U	195
TR2	● ▲	190	TU1	▲	191	UL050D	● ▲ U	195
TR3	● ▲	190	TU2	▲	191	UL050DC	● ▲	195
TR4	● ▲ ■ U	190	TUS1	▲	180	UL050E	● ▲ U	195
TR5	● ▲	190	TUS1R	▲	180	UL050F	● ▲ U	196
TR8	●	190	TUS2R	▲	180	UL050G	● ▲ U	196
TR9	●	190	TV1	●	188-246	UL050H	● ▲ U	196
TRE1	● U	3	TV2	● ■	188-246	UL050L	● ▲ U	196
TRE2	● U	3	TV3	● ■	188-246	UL050M	● ▲ U	197
TRE3	●	3	TV4	●	188-246	UL050SL	● ▲ C	196
TRF1	●	3	TW1	● ▲	191	UL050X	● ▲ U C S	197
TRF1R	●	3	TY1	● ▲	180	UL050XL	● ▲	196
TRF2	●	3	TZ1	● ▲	191	UL050Y	● ▲ U	197
TRF3	●	3	TZ2	● ▲	191	UL051	● ▲ U C S	194
TRF3R	●	3	TZ2R	● ▲	191	UL051B	● ▲	195
TRF4	●	3	TZN1	● ▲	180	UL051C	● ▲ U	195
TRF5R	●	3						

● Brass  
Ottone  
Messing  
Laiton  
Latón  
Latão

▲ Steel  
Acciaio  
Stahl  
Acier  
Acero  
Aço

■ Nickel silver  
Alpacca  
Neusilber  
Maillechort  
Alpaca  
Alpaca

◆ Iron  
Ferro  
Eisen  
Fer  
Hierro  
Ferro

Ⓒ Available in Color  
Disponibile in Color  
Lieferbar in Color  
Disponibile en Color  
Disponibile en Color  
Disponível em Color

Ⓘ Available in Ultralite  
Disponibile in Ultralite  
Lieferbar in Ultralite  
Disponibile en Ultralite  
Disponibile en Ultralite  
Disponível em Ultralite

Ⓔ Available in Silky  
Disponibile in Silky  
Lieferbar in Silky  
Disponibile en Silky  
Disponibile en Silky  
Disponível em Silky

REF.		PAGE	REF.		PAGE	REF.		PAGE
UL051D	●▲U	195	UL057	●▲U	194	UNI36R	●▲	193
UL051DC	▲	197	UL058	●▲UCS	194	UNI37	●▲	193
UL051E	●▲U	195	UL058A	●▲U	195	UNI37R	●▲	193
UL051F	●▲U	196	UL058SL	●▲C	197	UNI38	●▲	193
UL051G	●▲U	196	UL059	●▲UCS	194	UNI38R	●▲	193
UL051L	●▲U	196	UL059A	●▲U	195	UNI39	●▲	193
UL051M	●▲U	197	UL060	●▲U	194	UNI39R	●▲	193
UL051SL	●▲C	196	UL061	●▲U	194	UNI3S	▲U	193
UL051X	●▲U	197	UL062	▲	195	UNI4	▲	194
UL051XL	●▲	196	UL063	▲	195	UNI40	●▲	193
UL051Y	●▲U	197	UL064	▲	194	UNI40R	●▲	193
UL052	●▲UCS	195	UL064L	▲	196	UNI41	●▲	193
UL052B	●▲	195	ULS1R	▲	192	UNI41R	●▲	193
UL052C	●▲U	195	UM1	●▲	192	UNI44	●▲	193
UL052D	●▲U	195	UM1R	●▲	192	UNI44R	●▲	193
UL052E	●▲U	195	UM2	●▲	192	UNI45	●▲	193
UL052F	●▲	196	UNI1010	◆	269	UNI45R	●▲	193
UL052G	●▲U	196	UNI11	▲	193	UNI46	●	193
UL052H	●U	196	UNI12	●▲	158-194	UNI46R	●▲	193
UL052L	●▲U	197	UNI14	●▲	193	UNI47	●▲	193
UL052M	●▲U	197	UNI15	●▲	194	UNI47R	●▲	193
UL052SL	●▲C	197	UNI16	●▲	193	UNI48	●▲	193
UL052XL	●▲	197	UNI16R	●▲	193	UNI48R	●▲	193
UL053	●▲UCS	195	UNI18	▲	193	UNI49	●▲	193
UL053B	●▲	195	UNI22	●▲	194	UNI49R	●▲	193
UL053C	●▲U	195	UNI23	▲	194	UNI4R	▲	194
UL053D	●▲U	195	UNI27	●▲	194	UNI5	▲	194
UL053E	●▲U	195	UNI28	●▲	193	UNI50	●	193
UL053G	●▲U	196	UNI29	●▲	194	UNI50R	●▲	193
UL053L	●▲U	197	UNI3	●▲UC	193	UNI51	●	193
UL053M	●▲U	197	UNI30	●▲	194	UNI51R	●▲	193
UL053SL	●▲C	197	UNI31	●▲	193	UNI52	●▲	193
UL053XL	●	197	UNI31R	▲	193	UNI52R	●▲	193
UL054	●▲UCS	194	UNI32	●▲U	193	UNI54R	●▲	193
UL054L	●▲U	196	UNI32R	●▲U	193	UNI56R	●▲	194
UL054SL	●▲C	196	UNI33	●▲	193	UNI57R	▲	194
UL054XL	▲	196	UNI33R	●▲	193	UNI58R	▲	194
UL055	●▲U	194	UNI34	●▲	193	UNI59R	▲	194
UL055L	●▲U	196	UNI34R	●▲	193	UNI6	●▲	193
UL055SL	●▲C	196	UNI35	●▲	193	UNI60R	▲	194
UL055XL	▲	196	UNI35R	●▲	193	UNI61	●▲	194
UL056	●▲U	194	UNI36	●▲	193	UNI61R	▲	194

● Brass  
Ottone  
Messing  
Laiton  
Latón  
Latão

▲ Steel  
Acciaio  
Stahl  
Acier  
Acero  
Aço

■ Nickel silver  
Alpaca  
Neusilber  
Maillechort  
Alpaca  
Alpaca

◆ Iron  
Ferro  
Eisen  
Fer  
Hierro  
Ferro

C Available in Color  
Disponibile in Color  
Lieferbar in Color  
Disponibile en Color  
Disponibile en Color  
Disponível em Color

U Available in Ultralite  
Disponibile in Ultralite  
Lieferbar in Ultralite  
Disponibile en Ultralite  
Disponibile en Ultralite  
Disponível em Ultralite

S Available in Silky  
Disponibile in Silky  
Lieferbar in Silky  
Disponibile en Silky  
Disponibile en Silky  
Disponível em Silky



REF.		PAGE	REF.		PAGE	REF.		PAGE
UNI63	▲	194	VAC124	▲	202	VAC1R	▲	198
UNI66R	●	193	VAC125	▲	202	VAC2	●▲U C S	199
UNI67R	●	193	VAC126	▲	202	VAC20	●▲	200
UNI68R	▲	193	VAC127	▲	202	VAC20N	▲	200
UNI7	▲	193	VAC128	▲	202	VAC20R	●▲	200
UP1	▲	197	VAC129	▲	202	VAC20RN	●▲	200
UR1	●▲	198	VAC130	▲	202	VAC21	●▲	200
UR1R	●▲	198	VAC131	▲	202	VAC21N	▲	200
UR2	▲	198	VAC132	▲	202	VAC21R	●▲	200
UR2R	▲	198	VAC133	▲	202	VAC21RN	●▲	200
<b>V</b>			VAC134	▲	202	VAC22	●▲	200
VAC1	●▲	198	VAC135	▲	202	VAC22N	▲	200
VAC10	●▲	198	VAC136	▲	202	VAC22R	●▲	200
VAC100	●▲	198	VAC137	▲	202	VAC22RN	●▲	200
VAC100R	▲	198	VAC138	▲	202	VAC23	●▲	200
VAC101	▲	202	VAC139	▲	202	VAC23R	●▲	200
VAC103	■	202-247	VAC14	▲	199	VAC25	▲U	198
VAC104	■	202-247	VAC140	▲	202	VAC25R	●▲	198
VAC105	■	202-247	VAC141	▲	202	VAC29	▲C	199
VAC106	▲	198	VAC142	▲	202	VAC3	●▲U C	199
VAC106R	▲	198	VAC143	▲	202	VAC30	●▲	199
VAC107	▲	198	VAC144	▲	202	VAC30R	●▲	199
VAC107R	▲	198	VAC145	▲	202	VAC31	●▲	200
VAC108	▲	202	VAC146	▲	202	VAC31R	▲	200
VAC109	▲	202	VAC147	▲	202	VAC32	▲	200
VAC11	●▲	198	VAC148	▲	202	VAC33	▲	198
VAC110	▲	202	VAC15	●▲	200	VAC33R	●▲	198
VAC111	▲	202	VAC150	●	202-247	VAC34	●▲	200
VAC112	▲	202	VAC151	●▲ C S	202	VAC34R	▲	200
VAC113	▲	202	VAC152	■	203-247	VAC36	▲	200
VAC114	▲	202	VAC153R	■	203-247	VAC36R	●▲	200
VAC115	▲	202	VAC15R	●▲	200	VAC37	▲	200
VAC116	▲	202	VAC16	●▲	200	VAC37R	●▲	200
VAC117	▲	202	VAC16R	●▲	200	VAC38	●▲	200
VAC118	▲	202	VAC17	●▲	200	VAC38R	●▲	200
VAC119	▲	202	VAC17R	●▲	200	VAC39	▲	201
VAC11R	●▲	198	VAC18	●▲	200	VAC4	▲	199
VAC120	▲	202	VAC18R	●▲	200	VAC40	▲	200
VAC121	▲	202	VAC19	●▲	200	VAC40R	●▲	200
VAC122	▲	202	VAC19N	▲	200	VAC41	●▲	198
VAC123	▲	202	VAC19R	●▲	200	VAC42	▲	198
			VAC19RN	●▲	200	VAC42R	●▲	198

● Brass  
Ottone  
Messing  
Laiton  
Latón  
Latão

▲ Steel  
Acciaio  
Stahl  
Acier  
Acero  
Aço

■ Nickel silver  
Alpacca  
Neusilber  
Maillechort  
Alpaca  
Alpaca

◆ Iron  
Ferro  
Eisen  
Fer  
Hierro  
Ferro

Ⓒ Available in Color  
Disponibile in Color  
Lieferbar in Color  
Disponibile en Color  
Disponibile en Color  
Disponível em Color

Ⓘ Available in Ultralite  
Disponibile in Ultralite  
Lieferbar in Ultralite  
Disponibile en Ultralite  
Disponibile en Ultralite  
Disponível em Ultralite

Ⓔ Available in Silky  
Disponibile in Silky  
Lieferbar in Silky  
Disponibile en Silky  
Disponibile en Silky  
Disponível em Silky

REF.		PAGE	REF.		PAGE	REF.		PAGE
VAC44R	▲	198	VAC84	● ▲	201	VI12	▲	205
VAC45	▲	201	VAC85	● ▲	201	VI13	● ▲	205
VAC46	▲	198	VAC86	● ▲	201	VI14	●	206
VAC47	▲	199	VAC87	● ▲	201	VI15R	●	205
VAC48	● ▲ U S	201	VAC88	● ▲	201	VI16R	●	205
VAC49	● ▲	201	VAC89	▲	201	VI17	●	206
VAC5	▲	199	VAC8R	● ▲	198	VI18R	●	205
VAC50	● ▲	201	VAC91	■	202-247	VI19	●	205-248
VAC51	● ▲	201	VAL1	● ▲	203	VI1R	● ▲	205
VAC52	● ▲	201	VAL2	● ▲	203	VI2	●	206
VAC53	● ▲	201	VAR1	▲	203	VI23	▲	205
VAC54	● ▲	201	VAR1R	▲	203	VI2R	●	206
VAC55	● ▲	201	VAR2	▲	203	VI3	● U	205
VAC56	● ▲	199	VAR2R	▲	203	VI3R	● ▲ U	205
VAC57	● ▲	199	VAR3	▲	203	VI4	● ▲	206
VAC58	● ▲	199	VAR3R	▲	203	VI4R	● ▲	206
VAC6	▲	200	VAR4	▲	203	VI5	● ▲ U	205
VAC60	▲	198	VAR4R	▲	203	VI5R	● ▲ U	205
VAC60R	▲	198	VAR5	▲	203	VI6	●	205
VAC61	● ▲ U	199	VAV1	●	203	VI7	● ▲	206
VAC63	▲	199	VBH1R	●	204-248	VI7R	● ▲	206
VAC65	▲	198	VC1	▲	204	VI8	● ▲	205
VAC65R	● ▲	198	VC1R	● ▲	204	VI8R	● ▲	205
VAC66	● ▲	198	VEG1	▲	204	VI9	● ▲	205
VAC66R	● ▲	198	VG1	● U	205	VI9R	● ▲	205
VAC68	● ▲	201	VG2	● ▲	205	VK1	▲	206
VAC69	● ▲	201	VG3	● ▲	205	VK2	▲	206
VAC70	● ▲	201	VGD1	●	203-247	VL1	●	204
VAC71	● ▲	201	VI080	● ▲ U C S	205	VL1R	●	204
VAC72	● ▲	201	VI081	● ▲ U S	205	VL2	●	204
VAC73	● ▲	201	VI082	● ▲ U C S	206	VL2R	▲	204
VAC74	● ▲	201	VI083	● ▲ U	206	VL2RE	● ▲ U	113
VAC75	● ▲	201	VI084	● ▲ U C S	206	VL3	●	204
VAC76	● ▲	201	VI085	● ▲ U	206	VL3R	▲	204
VAC77	● ▲	201	VI086	● ▲ U C S	206	VL4	●	204
VAC78	● ▲	201	VI087	● ▲ U	206	VL4R	● ▲	204
VAC79	● ▲	201	VI088	● ▲	206	VL5E	● ▲	112-204
VAC8	● ▲	198	VI089	● ▲	206	VL5RE	● ▲	112-204
VAC80	● ▲	201	VI1	●	205	VLG1	▲	206
VAC81	● ▲	201	VI10	● ▲	206	VLK1R	● ▲	206
VAC82	● ▲	201	VI10R	● ▲	206	VLK2R	● ▲	206
VAC83	● ▲	201	VI11	▲	205	VN1	● ▲	205

● Brass  
Ottone  
Messing  
Laiton  
Latón  
Latão

▲ Steel  
Acciaio  
Stahl  
Acier  
Acero  
Aço

■ Nickel silver  
Alpaca  
Neusilber  
Maillechort  
Alpaca  
Alpaca

◆ Iron  
Ferro  
Eisen  
Fer  
Hierro  
Ferro

Ⓒ Available in Color  
Disponibile in Color  
Lieferbar in Color  
Disponibile en Color  
Disponibile en Color  
Disponível em Color

Ⓒ Available in Ultralite  
Disponibile in Ultralite  
Lieferbar in Ultralite  
Disponibile en Ultralite  
Disponibile en Ultralite  
Disponível em Ultralite

Ⓒ Available in Silky  
Disponibile in Silky  
Lieferbar in Silky  
Disponibile en Silky  
Disponibile en Silky  
Disponível em Silky

REF.		PAGE	REF.		PAGE	REF.		PAGE
VN1R	● ▲	205	VYK6	● ▲	217	WE4	● ▲	209
VOG1	●	207	VYK7	●	216	WE4R	● ▲	209
VR1	●	204	VYK8	▲	216	WE5	● ▲	208
VRF3	● ▲	204	VYP5A	▲	216	WE5R	● ▲	208
VRF4	● ▲	204	VYP5B	▲	216	WE6	●	208
VS090V	● ▲	206	VYP5D	●	216	WE6R	●	208
VSR1R	● ▲ U	203	VYP6A	● ▲	217	WE7	●	209
VSR2	▲	203	VYP6B	▲	217	WE7R	●	209
VSR2R	● ▲ U	203	VYP6D	▲	217	WE8	●	209
VYA	●	216	<b>W</b>			WEB1	● ▲	208
VYA6	● ▲	217	WA1	● ▲ U	207	WEB2	▲	208
VYA7	●	216	WA1R	● ▲ U C S	207	WEB3	▲	208
VYA8	▲	216	WA2	● ▲ U	207	WEB4	▲	208
VYB	● ▲	216	WA2R	● ▲ U C	207	WEB5	● ▲	208
VYB6	● ▲	217	WA3	● ▲ U	207	WEI1	● ▲ ■ U	208
VYB7	●	216	WA3R	●	207	WEI2	● ▲ U	208
VYB8	▲	216	WA4	●	207	WEI3	● ▲	208
VYC	● ▲	216	WA4R	● ▲	207	WEI4	● ▲ ■ U	208
VYC6	●	217	WA6	● ▲	207	WEI5	● ▲ ■ U	208
VYC7	●	216	WA6R	● ▲	207	WEI8	▲	208
VYC8	●	216	WA7	●	207	WEI9	●	208
VYD	● ▲	216	WA7R	● ▲	207	WFE1	●	209
VYD6	●	217	WA8	●	207-248	WFE1R	●	209
VYD7	●	216	WC1	● ▲ U	210	WGU1	● ▲	207
VYD8	▲	216	WC2	● U	210	WH1	● U	211
VYE	● ▲	216	WC3	●	210	WJ1R	●	207-248
VYE6	● ▲	217	WE1	● ▲ U S	208	WK1	● ▲ U	210
VYE7	▲	216	WE12	●	209	WK10	● ▲	211
VYE8	●	216	WE12R	●	209	WK11	● ▲	211
VYF	● ▲	216	WE13	●	209	WK12	▲	211
VYF6	● ▲	217	WE13R	●	209	WK13	▲	211
VYF7	●	216	WE14	● U	209	WK14	▲	211
VYF8	▲	216	WE14R	●	209	WK15	● ▲	211
VYG	● ▲	216	WE15	●	209	WK16	● ▲	210
VYG6	●	217	WE16	●	208	WK17R	● ▲	211
VYG7	●	216	WE16R	●	208	WK18	● ▲	210
VYG8	▲	216	WE1R	● ▲ U	208	WK19	● ▲	210
VYH	● ▲	216	WE2	● ▲ U	209	WK1X	▲ U C S	210
VYH6	● ▲	217	WE2R	● ▲ U	209	WK2	▲	211
VYH7	●	216	WE3	● ▲ U	209	WK20	● ▲	210
VYH8	▲	216	WE3R	● ▲ U	209	WK21	● ▲	210
VYK	● ▲	216				WK22	● ▲	210

● Brass  
Ottone  
Messing  
Laiton  
Latón  
Latão

▲ Steel  
Acciaio  
Stahl  
Acier  
Acero  
Aço

■ Nickel silver  
Alpacca  
Neusilber  
Maillechort  
Alpaca  
Alpaca

◆ Iron  
Ferro  
Eisen  
Fer  
Hierro  
Ferro

Ⓒ Available in Color  
Disponibile in Color  
Lieferbar in Color  
Disponibile en Color  
Disponibile en Color  
Disponível em Color

Ⓘ Available in Ultralite  
Disponibile in Ultralite  
Lieferbar in Ultralite  
Disponibile en Ultralite  
Disponibile en Ultralite  
Disponível em Ultralite

Ⓔ Available in Silky  
Disponibile in Silky  
Lieferbar in Silky  
Disponibile en Silky  
Disponibile en Silky  
Disponível em Silky

REF.		PAGE	REF.		PAGE	REF.		PAGE
WK25	● ▲	211	WK62R	▲	211	XBD1	●	255
WK25R	▲	211	WK63R	▲	210	XBD2	●	255
WK26	▲	210	WK68R	●	210	XBD3	●	255
WK27	▲	210	WK69	● ▲	210	XBD4	●	255
WK28	▲	210	WK6R	● ▲	211	XBD5	●	255
WK29	● ▲	210	WK7	● ▲	210	XBD6	●	255
WK2R	▲	211	WK70	●	211-248	XBD7	●	255
WK3	▲	93-210	WK71X	▲	211	XBRA1P	●	253
WK30	● ▲	210	WK8	● ▲	210	XBRY1	◆	253
WK31	● ▲	210	WK87X	▲	211	XBRY2	◆	253
WK32	▲	210	WK8R	● ▲	210	XBW1	◆	254
WK33	● ▲	210	WK9	● ▲	211	XBW1P	◆	254
WK34	● ▲	210	WK91R	▲	210	XBW2	◆	254
WK35	▲	210	WLC1	▲	211	XBW2P	◆	254
WK36	▲	210	WMS1	● ▲	211	XBW3	◆	254
WK37	▲	210	WMS2	▲	211	XBW3P	◆	254
WK38	▲	210	WR1	●	211	XBW4	◆	254
WK39	● ▲	210	WR2	▲	211	XBW4P	◆	254
WK4	▲	211	WR3	▲	211	XBW5	◆	255
WK40	● ▲	210	WR4	▲	211	XBW5P	◆	255
WK41R	● ▲	211	WR5R	▲	211	XC1	●	256
WK42R	● ▲	211	WS1	● ▲ U	209	XCCF10	●	256
WK43R	▲	211	WS2	● U	209	XCCF2	●	255
WK44R	▲	211	WS3	▲	209	XCCF3	●	255
WK45R	● ▲	211	WSA1	● ▲	207	XCCF6	●	256
WK45X	▲	211	WSD1	● ▲	212	XCCF7	●	256
WK46	▲	210	WSD1R	● ▲	212	XCCF8	●	256
WK47R	● ▲	211	WST1	● ▲	209	XCCF9	●	256
WK48	▲	210	WST2	● ▲	209	XF1P	◆	257
WK49R	▲	210	WST3	● ▲	209	XF2	◆	257
WK5	▲	210	WST4	●	209	XF2P	◆	257
WK50R	▲	210	WST5	●	209	XFB1	◆	256
WK51R	▲	210	WTR1R	▲	208	XFB1P	◆	257
WK52R	▲	211	WU1R	●	208-248	XFP1	◆	257
WK53R	● ▲	211				XG1P	◆	257
WK54R	▲	211				XG2P	◆	257
WK55	● ▲	210				XGR1	●	257
WK56R	●	211				XH1	◆	258
WK57	▲	210				XH2	◆	258
WK59R	▲	210				XH3	◆	258
WK6	▲	211				XIE3	◆	258
WK60R	● ▲	210				XIE4	◆	258

● Brass  
Ottone  
Messing  
Laiton  
Latón  
Latão

▲ Steel  
Acciaio  
Stahl  
Acier  
Acero  
Aço

■ Nickel silver  
Alpaca  
Neusilber  
Maillechort  
Alpaca  
Alpaca

◆ Iron  
Ferro  
Eisen  
Fer  
Hierro  
Ferro

Ⓒ Available in Color  
Disponibile in Color  
Lieferbar in Color  
Disponibile en Color  
Disponibile en Color  
Disponível em Color

Ⓘ Available in Ultralite  
Disponibile in Ultralite  
Lieferbar in Ultralite  
Disponibile en Ultralite  
Disponibile en Ultralite  
Disponível em Ultralite

Ⓔ Available in Silky  
Disponibile in Silky  
Lieferbar in Silky  
Disponibile en Silky  
Disponibile en Silky  
Disponível em Silky

REF.		PAGE	REF.		PAGE	REF.		PAGE
XKV10	◆	259	XY7	◆	264	YA1E	●▲UC	212
XKV11	◆	259	XYAT11	◆	264	YA1ER	●▲U	212
XKV2	◆	259	XZ1A	◆	265	YA1R	●▲U	158-212
XKV6	◆	259	XZ1AP	◆	265	YA2	●▲U	217
XKV7	◆	259	XZ1B	◆	265	YA20	▲	213
XKV8	◆	259	XZ1BP	◆	265	YA20R	▲	213
XM1	◆	260	XZ1CP	◆	265	YA21	●	213
XM2	◆	260	XZ2A	◆	265	YA22	●	213
XMBL1P	●	260	XZ2AP	◆	265	YA226	●▲UC	214
XMBL2P	●	260	XZ2B	◆	265	YA227	●▲U	214
XMR1	◆	260	XZ2BP	◆	265	YA23	●▲U	213
XMR2P	●	260	XZ2CP	◆	265	YA24	●▲	213
XN1	◆	261	XZ3A	◆	266	YA25	●	213
XN1P	◆	261	XZ3AP	◆	266	YA26	●▲	213
XN3	◆	261	XZ3BP	◆	266	YA27R	●▲	212
XNA1	◆	260	XZ3CP	◆	266	YA29	●	212
XOC1	◆	261	XZ5A	◆	265	YA29R	●	212
XPDO1P	●	261	XZ6AP	◆	266	YA2R	●▲	217
XPK1	◆	262	XZAS1	◆	264	YA3	●▲	213
XPK2	◆	262	XZAS2	◆	264	YA30	●	213
XPZ1	◆	261	XZAS3	◆	264	YA30R	●▲	213
XPZ1P	●	261				YA31	●▲UCS	214
XPZ2	◆	261				YA31R	●▲U	214
XPZ2P	●	261				YA32	●▲	213
XRC1	◆	256				YA32R	●	213
XRC2	◆	256				YA33	●	215
XSAM3	●	262				YA33R	●	215
XSLH1P	◆	262				YA34	●	212
XSLH2P	◆	262				YA35	●▲	212
XTF1	◆	262				YA36	●U	212
XTF2	◆	262				YA38	●▲	212
XTF3	◆	262				YA39	●	215
XY1	◆	263				YA39P	●▲	215
XY10P	◆	263				YA3R	●▲	213
XY1P	◆	263				YA4	●▲U	213
XY2	◆	263				YA40P	●	215
XY2P	◆	263				YA41	●▲	214
XY3P	◆	263				YA42	●	214
XY4	◆	263				YA43	●▲	214
XY4P	◆	263				YA44	●▲	214
XY5P	◆	263				YA45	●	214
XY6P	◆	263				YA46	●▲	214

- Brass  
Ottone  
Messing  
Laiton  
Latón  
Latão
- ▲ Steel  
Acciaio  
Stahl  
Acier  
Acero  
Aço
- Nickel silver  
Alpacca  
Neusilber  
Maillechort  
Alpaca  
Alpaca
- ◆ Iron  
Ferro  
Eisen  
Fer  
Hierro  
Ferro
- C Available in Color  
Disponibile in Color  
Lieferbar in Color  
Disponibile en Color  
Disponibile en Color  
Disponível em Color
- U Available in Ultralite  
Disponibile in Ultralite  
Lieferbar in Ultralite  
Disponibile en Ultralite  
Disponibile en Ultralite  
Disponível em Ultralite
- S Available in Silky  
Disponibile in Silky  
Lieferbar in Silky  
Disponibile en Silky  
Disponibile en Silky  
Disponível em Silky

REF.		PAGE	REF.		PAGE	REF.		PAGE
YA47	●	214	YA74R	● ▲	215	YT12	● ▲	218
YA48	● ▲	214	YA7R	● ▲ U	215	YT12R	● ▲	218
YA49	● ▲	214	YA8	● ▲	213	YT13	● ▲	218
YA4R	● ▲ U	213	YA84	▲	212	YT13R	● ▲	218
YA5	● ▲ ■ U	212	YA84R	▲	212	YT14	● ▲	218
YA50	● ▲	214	YA85R	●	212	YT14R	● ▲	218
YA51	● ▲	214	YA86	▲	212	YT15	● ▲ U G	126
YA52	●	214	YA86R	●	212	YT15R	● ▲	126
YA53	● ▲	214	YA87	▲	214	YT15RX	▲	126
YA54	● ▲	214	YA88	▲	213	YT15X	● ▲ U	126
YA55	● ▲	214	YA89	● ▲	213	YT16	● ▲ G	126
YA56	● ▲	214	YA8E	▲	213	YT16X	● ▲	126
YA57	● ▲	214	YA8ER	● ▲	213	YT1R	● ▲	218
YA58	● ▲	214	YA8R	● ▲	213	YT2	● ▲	219
YA59	● ▲	214	YA9	●	34-212	YT2R	▲	219
YA5R	● ▲ U	212	YA90	●	214-248	YT3	▲	218
YA6	● ▲ U G	215	YA91	● ▲	213	YT3R	▲	218
YA60	● ▲	214	YA93	▲	214	YT4	● ▲	219
YA61	● ▲	214	YA94	●	214-248	YT4R	● ▲	219
YA62	● ▲	214	YA95R	●	214-248	YT5	●	219
YA63	● ▲	214	YA98R	●	214	YT5R	● ▲	219
YA64	● ▲	212	YA99R	●	214-248	YT6	● ▲	218
YA64R	● ▲	212	YAR1	●	218	YT6R	● ▲	218
YA65	●	213	YD1	● U	218	YT7	● ▲	218
YA65R	●	213	YD12	●	218	YT7R	● ▲	218
YA66	● ▲	213	YD13R	●	218-249	YT8	▲	218
YA66R	● ▲	213	YD14R	●	218-249	YT8R	▲	218
YA67	●	212	YD1R	● ▲	218	YT9	● ▲	219
YA68	● ▲	213	YD2	● ▲	218	YT9R	● ▲	219
YA68R	● ▲	213	YD2R	● ▲	218	YUH1R	▲	219
YA69	● ▲	213	YD3R	● ■	218-248	YUH2R	▲	219
YA69R	● ▲	213	YD4	● ▲ U	218	YYA	● ▲	217
YA6R	● ▲ U	215	YD4R	▲ U	218	YYA6	●	217
YA7	● ▲ U	215	YD5R	● U	218	YYA7	●	215
YA70	▲	217	YD6R	● ▲ ■ U	218-248	YYB	●	217
YA70R	▲	217	YD7R	● U	218-249	YYB6	● ▲	217
YA71	▲	217	YM18	▲	178	YYB7	●	215
YA71R	● ▲	217	YT1	● ▲	218	YYC	● ▲	217
YA72	● ▲	216	YT10	● ▲	219	YYC6	●	217
YA72R	▲	216	YT10R	● ▲	219	YYC7	●	215
YA73P	●	215	YT11	● ▲	219	YYD	●	217
YA74	● ▲	215	YT11R	● ▲	219	YYD6	● ▲	217

● Brass  
Ottone  
Messing  
Laiton  
Latón  
Latão

▲ Steel  
Acciaio  
Stahl  
Acier  
Acero  
Aço

■ Nickel silver  
Alpaca  
Neusilber  
Maillechort  
Alpaca  
Alpaca

◆ Iron  
Ferro  
Eisen  
Fer  
Hierro  
Ferro

Ⓒ Available in Color  
Disponibile in Color  
Lieferbar in Color  
Disponible en Color  
Disponibile en Color  
Disponível em Color

Ⓔ Available in Ultralite  
Disponibile in Ultralite  
Lieferbar in Ultralite  
Disponible en Ultralite  
Disponibile en Ultralite  
Disponível em Ultralite

Ⓕ Available in Silky  
Disponibile in Silky  
Lieferbar in Silky  
Disponible en Silky  
Disponibile en Silky  
Disponível em Silky

REF.		PAGE	REF.		PAGE	REF.		PAGE
YYD7	●	215	ZE10	● ▲	221	ZI3	● ▲	220
YYE	● ▲	217	ZE10R	● ▲	221	ZI3R	● ▲	220
YYE6	● ▲	217	ZE11	● ▲	220	ZI4	● ▲	220
YYE7	●	215	ZE11R	● ▲	220	ZI4R	● ▲	220
YYF	● ▲	217	ZE12	● ▲ U	221	ZI5	▲	220
YYF6	● ▲	217	ZE13	● ▲	221	ZI5R	●	220
YYF7	●	215	ZE13R	● ▲	221	ZN1	● ▲	221
YYG	● ▲	217	ZE14	● ▲	220	ZO1	●	222
YYG6	● ▲	217	ZE14R	● ▲	220			
YYG7	●	215	ZE15	▲	221			
YYH	● ▲	217	ZE16	▲	221			
YYH6	● ▲	217	ZE1R	● ▲ U	221			
YYH7	●	215	ZE1RX	▲ U C	220			
YYK	● ▲	217	ZE1X	▲ U C S	220			
YYK6	● ▲	217	ZE2	● ▲ U C	221			
YYK7	●	215	ZE3	▲	221			
YYP5A	●	217	ZE30	● ▲	221			
YYP5B	▲	217	ZE30R	● ▲	221			
YYP5D	▲	217	ZE34	▲	221			
YYP6A	▲	217	ZE34R	▲	221			
YYP6B	▲	217	ZE34RX	▲	220			
YYP6D	▲	217	ZE34X	▲	220			
YYP7R	●	215	ZE39	▲	221			
<b>Z</b>			ZE39R	▲	221			
ZA2R	● ▲	220	ZE39RX	▲	220			
ZD10P	● ▲	206	ZE39X	▲	220			
ZD11	▲	38-219	ZE3R	▲	221			
ZD11P	●	38-219	ZE4	● ▲	221			
ZD14RP	● ▲	219	ZE40X	● ▲	220			
ZD25	●	220-249	ZE42	▲	220			
ZD26R	●	220	ZE45	■	220			
ZD4	▲	219	ZE46	▲	220			
ZD4R	▲	219	ZE46R	▲	220			
ZD5	▲	219	ZE5	● ▲	221			
ZD5R	▲	219	ZE58	▲	221			
ZD6	● ▲	219	ZE5R	● ▲	221			
ZD7	● ▲	38-219	ZE7	● ▲	221			
ZD8	▲	219	ZH1R	●	222-249			
ZD9	● ▲	38-219	ZI1	● ▲	220			
ZD9P	● ▲	38-219	ZI1R	● ▲	220			
ZE1	● ▲ U C	221	ZI2	● ▲	220			
			ZI2R	● ▲	220			

● Brass  
Ottone  
Messing  
Laiton  
Latón  
Latão

▲ Steel  
Acciaio  
Stahl  
Acier  
Acero  
Aço

■ Nickel silver  
Alpacca  
Neusilber  
Maillechort  
Alpaca  
Alpaca

◆ Iron  
Ferro  
Eisen  
Fer  
Hierro  
Ferro

Ⓒ Available in Color  
Disponibile in Color  
Lieferbar in Color  
Disponibile en Color  
Disponibile en Color  
Disponível em Color

Ⓘ Available in Ultralite  
Disponibile in Ultralite  
Lieferbar in Ultralite  
Disponibile en Ultralite  
Disponibile en Ultralite  
Disponível em Ultralite

Ⓔ Available in Silky  
Disponibile in Silky  
Lieferbar in Silky  
Disponibile en Silky  
Disponibile en Silky  
Disponível em Silky



**EN** - All information and illustrations in this catalogue are for guidance only. Silca reserves the right to alter products designs, dimensions or info to improve the products quality.

The contents of this catalogue are fully protected by Copyright and may not be copied or reproduced in any form, without written permission from Silca. Any infringements will be dealt with under Italian law.

**IT** - Le illustrazioni e i dati tecnici dei prodotti contenuti nel catalogo debbono considerarsi indicativi.

Silca si riserva il diritto, ferme restando le caratteristiche essenziali dei prodotti, di apportare tutte le modifiche che ritiene necessarie e opportune al fine di migliorare la qualità dei prodotti.

Tutti i disegni e le fotografie sono di proprietà di Silca, ogni riproduzione anche parziale, senza autorizzazione scritta della Silca è vietata secondo termini di legge. Per qualsiasi controversia competenti sono gli Uffici Giudiziari dove ha sede l'Azienda, con espressa esclusione di qualsiasi altro foro.

**DE** - Die Abbildungen und technischen Daten des Katalogs sind nur zur Information.

Silca behält sich vor, etwaige Änderungen am Produkt, die zur Verbesserung desselben beitragen vorzunehmen.

Alle Zeichnungen und Fotos sind Besitz der Firma Silca, jede Reproduktion, auch teilweise, ist ohne schriftliche Erlaubnis der Firma Silca gesetzlich untersagt. Im Falle von Streitfragen ist der Gerichtshof des Firmensitzes zuständig; jeder andere Gerichtshof ist ausgeschlossen.

**FR** - Les illustrations et les caractéristiques techniques des produits présentés dans ce catalogue sont données à titre indicatif.

Bien que les caractéristiques essentielles des produits soient invariables, Silca se réserve le droit d'apporter toutes les modifications qu'elle retiendra nécessaires et opportunes afin d'améliorer la qualité de ses produits.

Tous les dessins et photos sont propriété Silca et toute reproduction, même partielle, sans l'autorisation écrite préalable de Silca est interdite conformément aux prescriptions légales. Tout litige est du ressort exclusif des Tribunaux de la circonscription où se trouve le Siège de la Société.

**ES** - Las ilustraciones y los datos técnicos de los productos en este catálogo son indicativos.

La Silca se reserva el derecho, quedando invariadas las características principales de los productos, de modificar todo lo que considere necesario y oportuno para mejorar la calidad de sus artículos. Todos los dibujos y las fotografías pertenecen a la Silca; según determina la Ley, se prohíbe toda reproducción aunque parcial, sin autorización por escrito de la Silca.

En caso de disputas la competencia es de las autoridades judiciales donde está domiciliada la firma, excluyendo cualquier otro foro.

**PT** - As ilustrações e as características técnicas dos produtos apresentados neste catálogo são facultados a título indicativo.

Mesmo que as características essenciais dos produtos sejam invariáveis, à Silca reserva-se o direito de modificar ser necessário e oportuno los productos, afim de melhorar a sua qualidade.

Todos os desenhos e fotos são propriedade da Silca, e é proibida a sua reprodução mesmo parcial sem a autorização escrita da Silca conforme as prescrições legais. Em caso de litígio fica desde já designado, excluindo qualquer outro, o Tribunal da comarca onde está registada a sede da Silca.





**EN** - In compliance with current regulations relating to industrial property, we hereby state that the trade-marks or trade names mentioned in our catalogue are the exclusive property of authorized manufacturers of locks and users. Said trade-marks or trade names are nominated only for the purposes of information so that any lock for which our keys are made can be rapidly identified. This catalogue is reserved exclusively for professional key cutters who use Silca products.

**IT** - In conformità alle disposizioni legali in vigore relative alle proprietà industriali, informiamo che i marchi o le denominazioni commerciali citate nel nostro catalogo sono di proprietà esclusiva dei fabbricanti di serrature e degli utilizzatori autorizzati. Questi marchi o denominazioni commerciali sono indicati a titolo di semplice informazione, con lo scopo di riconoscere velocemente a quali serrature le nostre chiavi sono destinate. Questo catalogo è esclusivamente riservato ai professionisti della riproduzione chiavi che utilizzano i prodotti Silca.

**DE** - Gemäß der derzeit geltenden Normen bezüglich des Industrieigentums teilen wir Ihnen mit, daß die im vorliegenden Katalog angeführten Markennamen oder Handelsmarken ausschließliches Eigentum der Schloßhersteller und zugelassenen Fachhändler sind. Diese Markenbezeichnungen oder Handelsmarken sind nur zur Information angeführt, mit dem Zweck, schnell erkennen zu können, zu welchem Schloß unsere Schlüssel gehören. Der vorliegende Katalog ist ausschließlich an Schlüsselkopier-Fachgeschäfte, die Silca Produkte benutzen, gerichtet.

**FR** - Conformément aux lois en vigueur concernant la propriété industrielle, nous vous informons que les marques et appellations commerciales citées dans notre catalogue appartiennent exclusivement aux fabricants de serrures et aux utilisateurs autorisés. Ces marques ou appellations commerciales sont indiquées à titre d'information pure et simple pour vous permettre de déterminer rapidement les serrures auxquelles nos clés sont destinées. Ce catalogue est réservé exclusivement aux professionnels du taillage de clés qui utilisent les produits Silca.

**ES** - En conformidad con las vigentes disposiciones de ley sobre propiedad industrial, las marcas y denominaciones comerciales citadas en nuestro catálogo se declaran de propiedad exclusiva de los fabricantes de cerraduras y los utilizadores autorizados. Dichas marcas o denominaciones comerciales se citan por simple información, al objeto de hacer comprender sin dificultad a qué cerraduras van destinadas nuestras llaves. Este catálogo está reservado exclusivamente a los profesionales de la reproducción de llaves que utilizan los productos Silca.

**PT** - Em conformidade com as disposições legais em vigor relativas à propriedade industrial, informamos que as marcas ou as denominações comerciais citadas no nosso catálogo são propriedade exclusiva dos fabricantes de fechaduras e dos utilizadores autorizados. Estas marcas ou denominações comerciais são indicadas só a nível de informação, a fim de reconhecer rapidamente a quais fechaduras se destinam as nossas chaves. Este catálogo é reservado exclusivamente aos profissionais da reprodução de chaves que utilizam os produtos Silca.

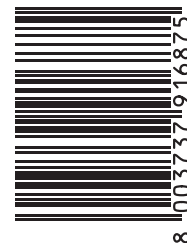

P1BA  
Printed in Italy 09/2018

**ITALY AND OTHER COUNTRIES  
SILCA S.p.A.**

Via Podgora, 20 (Z.I.)  
31029 VITTORIO VENETO (TV)  
Tel. +39 0438 9136  
Fax +39 0438 913800  
E-mail: [silca@silca.it](mailto:silca@silca.it)  
[www.silca.biz](http://www.silca.biz) - [www.silca.it](http://www.silca.it)

**FRANCE  
SILCA S.A.S.**

12, Rue de Rouen  
Z.I. Limay-Porcheville  
78440 PORCHEVILLE  
Phone: +33 1 30983500  
Fax +33 1 30983501  
E-mail: [info@silca.fr](mailto:info@silca.fr)  
[www.silca.fr](http://www.silca.fr)

**GERMANY  
SILCA GmbH**

Siemensstrasse, 33  
42551 VELBERT  
Phone: +49 2051 2710  
Fax +49 2051 271172  
E-mail: [info@silca.de](mailto:info@silca.de)  
[www.silca.de](http://www.silca.de)

**BENELUX  
H. CILLEKENS & B.V.**

Metaalweg, 4  
6045 JB ROERMOND  
Phone: +31 475 325147  
Fax +31 475 323640  
E-mail: [info@hcillekens.nl](mailto:info@hcillekens.nl)  
[www.hcillekens.nl](http://www.hcillekens.nl)

**UNITED KINGDOM  
SILCA**

Unit 6 Lloyds Court  
Manor Royal  
CRAWLEY RH10 9QU  
Phone: +44 1293 531134  
Fax +44 1293 531108  
E-mail: [sales@silcald.co.uk](mailto:sales@silcald.co.uk)  
[www.silcald.co.uk](http://www.silcald.co.uk)

**UNITED KINGDOM  
ADVANCED DIAGNOSTICS Ltd.**

Eastboro Fields  
Hemdale Business Park  
CV11 6GL NUNEATON  
Phone: +44 2476 347000  
Fax + 44 2476 347100  
E-mail: [sales@advanced-diagnostics.com](mailto:sales@advanced-diagnostics.com)  
[www.advanced-diagnostics.com](http://www.advanced-diagnostics.com)

**SPAIN  
SILCA KEY SYSTEMS S.A.**

C/Santander 73A  
08020 BARCELONA  
Phone: +34 93 4981400  
Fax +34 93 2788004  
E-mail: [silca@silca.es](mailto:silca@silca.es)  
[www.silca.es](http://www.silca.es)

Copyright by Silca S.p.A. 2018



dormakaba Group



NETWORK WITH US