

MULTIBLINDO

Range of locks
for metal frame doors



Multiblindo



The **Multiblindo** range of locks is designed by ISEO to be installed on doors with a high-security metal frames and to guarantee the maximum level of security and reliability.

The installation of Multiblindo locks is recommended to protect the entrances of residential buildings, businesses environments such as shops and offices, banks, shopping centres, hospitals, public offices etc.

To further enhance the security level of a door, Multiblindo locks can be combined with ISEO's European profile cylinders, which meet the highest security standards.

For more information you can refer to the iseo.com website

Multiblindo locks are products that are characterised by **higher performances** compared to those required by the most restrictive European standards, from the point of view of:



SECURITY

for all locks of the range that are break-in resistant, even in the case of heavy attacks, to protect goods contained within the environments.



SAFETY

for EXIT versions that provide the guarantee of rapid exit of people or evacuation from an environment in case of emergency.

The **Multiblindo** locks range meets the different needs of versatility, modularity, and level of security required by the application context. With this purpose Multiblindo is available in three models:

Classic

mechanical lock for high resistant doors



LATERAL BLINDO



MULTIPOINT

Classic + Extension



MULTIPOINT with extension

Easy

mechanical and self-locking lock for high resistant doors



LATERAL EXIT for emergency or panic device



MULTIPOINT

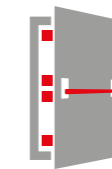

MULTIPOINT EXIT for emergency or panic device

Easy + Extension

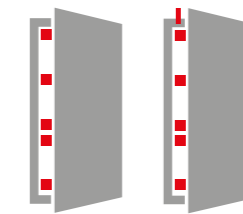

MULTIPOINT with extension

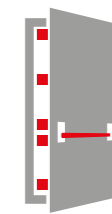

MULTIPOINT EXIT with extension for emergency or panic device

Emotion

electromechanical and self-locking lock for high resistant doors which require electronic opening control

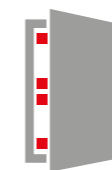

MULTIPOINT

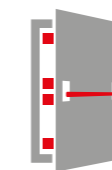

MULTIPOINT EXIT for emergency or panic device

Emotion + Extension

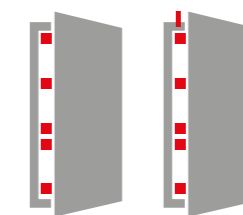

MULTIPOINT with extension

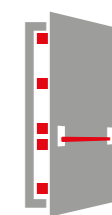

MULTIPOINT EXIT with extension for emergency or panic device

Multiblindo Classic



Highest quality and security mechanical lock: its strong point is its high resistance to break-in, making it the perfect choice to protect entrances equipped with multiple locking points and with a high degree of security (the highest in the reference standards).

Multiblindo Easy



Mechanical and self-locking lock, suitable for doors with different locking points and with a high level of security (the highest according to reference standards).

According to the requirements of the installation and the daily use of the door, it is possible to personalize the security level by choosing among three reclosing options of the lock.

Multiblindo Emotion



Electromechanical and self-locking lock suitable for doors with different locking points and with a high level of security (the highest grade according to reference standards).

According to the requirements of the installation and the daily use, it is possible to personalize the security level by choosing among three reclosing options of the lock.

The electromechanical opening allows control of accesses and manage the openings even by remote. The lock is equipped with ringing feedback when the user opens and closes the door.



Multiblindo Easy EXIT:
panic version

- Entrance doors of residential environments
- Entrance doors of companies and offices
- Entrance doors of shops and shopping centres

- Banks panic exit routes
- Jewellers entrances
- Post and public offices entrances and panic exit routes
- Legal offices entrances
- Laboratories facilities entrances
- Shopping centres entrances and panic exit routes



Multiblindo Emotion EXIT:
panic version

- Banks entrances and panic exit routes
- Jewellers entrances
- Post and public offices entrances and panic exit routes
- Legal offices entrances
- Laboratories facilities entrances
- Shopping centres entrances and panic exit routes

All Multiblindo locks are suitable to be installed on glass doors made with reinforced aluminium profiles or iron metal and blind steel or wooden doors.



The highlights of **Multiblindo** locks range

Reinforced deadbolts with 27 mm projection

The deadbolts of Multiblindo locks are reinforced through hardened steel plates on both sides: this material gives greater resistance to cutting and drilling. The deadbolts can be swinging or hook type with anti-lift pin: both models provide better locking and resistance of the door to burglary.



Deadbolt with deadlocking system

Multiblindo products are locks extremely high resistant and are also certified according to the maximum levels (grade 7) of the following reference standards EN12209, pr EN15685, EN14846 which guarantee:

- resistance to lateral and bottom forcing with a load of over 1000 kg;
- resistance to a front load of over 600 kg.

Deadbolts with independent resistance at burglary

Each deadbolt is designed to offer its own resistance to break-in attempts. This feature allows, in the event of burglary attempt on one deadbolt, that the others continue to resist independently. The attack must be repeated for each individual locking point.

Faceplates in stainless steel

All Multiblindo faceplates are crafted in stainless steel and this provides the double advantage of conferring resistance and solidity to the locks, which at the same time are perfectly integrated with the most modern architectural contexts.

Closed lock case equipped with fixing holes

The locks are closed on all sides: to prevent that bars from machining can jam the lock mechanisms and to make an high resistance of the door to a possible burglary attempted from the back of the lock. Finally, the case is equipped with through holes for easy the handle fixing with screws and protection plates for the cylinder.

Compatible with European profile cylinders

The locks of Mutliblindo range are compatible with European profile cylinders. In particular also with regard to the cylinders - starting with the basic ones, up to the top top of the range that meet the requirements of high security requirements - ISEO products are able to guarantee resistance to external attacks, reliability, durability and protection against attempts of unauthorized key duplication.

Extension with fourth and fifth locking point

Extensions that can be combined with multipoint locks allow the introduction of one or two additional locking points on doors up to a height of 3220 mm providing security and robustness even on large doors.

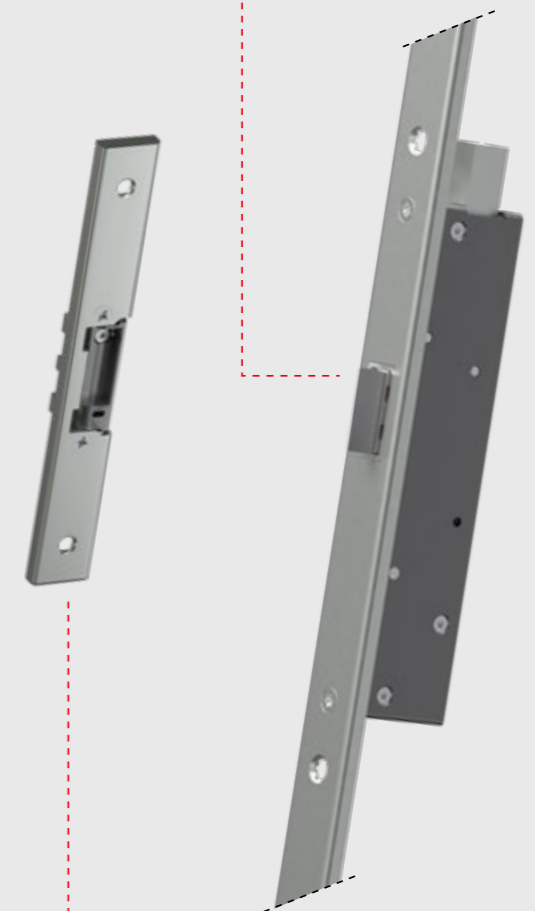

Adjustable strike plates in stainless steel

All strike plates are closed, adjustable and made of stainless steel. You can choose between the mechanical or electric version: this is an essential feature both for final adjustments on site and for regular maintenance of the frames.

Certificates

For a conscious choice, it is a good idea to identify the most compatible **Multiblindo** according with the security requirements of the installation context and in full compliance with the regulations.

The diagram below summarises the main certifications obtained by ISEO Multiblindo locks.



| Security | | |
|---|-------------------------------------|--|
| Mechanic | | Electromechanics |
| EN12209:2016 (grade 7) | pr EN15685:2022 (grade7) | EN14846:2008 (grade 7) |
| Lateral lock | Multipoint lock | Electromechanical locks |
| <p>These regulations specify the requirements and testing methods for durability, resistance, security and functionality of mechanically operated locks, for use on doors, French windows and entrance doors.</p> | | <p>This regulation specifies the requirements and testing methods for durability, resistance, security and functionality of electromechanically or electronically operated locks, for use on doors, French windows and entrance doors.</p> |

| | | | |
|----------------|--|-------------------|-----------------------|
| Classic | Lateral | I3IXI9IAI0IGI7I0I | |
| | Multipoint | | I3IXI9IAI0IGI7I0I3I0I |
| | Multipoint + Extension | | I3IXI6IAI0IFI7I0I3I0I |
| Easy | Lateral EXIT | I3IXI9IBI0IGI7I0I | |
| | Multipoint | | I3IXI9IBI0IGI7I0I3I0I |
| | Multipoint EXIT | | I3IXI9IBI0IGI7I0I3I0I |
| | Multipoint + Extension (4/5 points) | | I3IXI6IAI0IFI7I0I3I0I |
| Emotion | Multipoint EXIT + Extension (4 points) | | I3IXI6IAI0IFI7I0I3I0I |
| | Multipoint | | I3IXI9FI0IPI7I1I3I |
| | Multipoint EXIT | | I3IXI9FI0IPI7I1I3I |
| | Multipoint + Extension (4/5 points) | | I3IXI6IAI0IPI7I1I3I |
| | Multipoint EXIT + Extension (4 points) | | I3IXI6IAI0IPI7I1I3I |

| Safety | | Security classification of different markets | | |
|--|---|--|---|---|
| Panic/Escapes routes | | | | |
| CE - EN179:2008 | CE - EN1125:2008 | VDS | IMP | EN1627 |
| | | | | |
| Locks for emergency doors | Locks for panic doors | Independent German Institute | Independent Polish Institute | |
| Doors that can be opened onto escape routes by trained people inside spaces with a limited number of people, in which emergency situations could arise (lock with a lever handle). | Doors that can be opened onto escape routes by many untrained people in public spaces in which panic situations could arise (lock with a lever handle). | A VDS certification gives commercial and private consumers important advice in the distinction between products and services with different levels of security. Multiblindo locks have received the highest security certificate, the Class C. | Certifies products on the basis of European regulations and specific Polish market regulations. | This regulation establishes requirements, classification and resistance to breakingthrough for doors (and not for locks). The locks are suitable for any door in the maximum class RC6. |
| | | | X | RC4 |
| | | Class C | X | RC4 |
| | | | | RC4 |
| I3I7I7IBI1I4I5I2IAIBI | I3I7I7IBI1I4I2I1IAIBI | | | RC4 |
| | | Class C | X | RC4 |
| I3I7I7IBI1I4I5I2IAIBI | I3I7I7IBI1I4I2I1IAIBI | Class C | | RC4 |
| | | | | RC4 |
| I3I7I7IAI1I3I5I2IAIAIBI | I3I7I7IAI1I3I2I2IAIAIBI | | | RC4 |
| | | Class C | | RC4 |
| I3I7I7IBI1I4I5I2IAIBI | I3I7I7IBI1I4I2I1IAIBI | Class C | | RC4 |
| | | | | RC4 |
| I3I7I7IAI1I3I5I2IAIAIBI | I3I7I7IAI1I3I2I1IAIAIBI | Class C | | RC4 |

Multiblindo Classic

| | |
|------------------|--|
| Centre distances | 92 mm |
| Backsets | Multipoint: 25-30-35-40-45-50-55-60-65 mm Lateral: 25-30-35-40 mm |
| Handle Followers | 8 mm |
| Lock case | Equipped with through holes for easy the handle fixing with screws |
| Front plates | Lateral locks with sections: <ul style="list-style-type: none"> ■ U 24x6 in stainless steel for aluminium doors ■ U 24x5 in stainless steel for iron doors ■ U 22x7 in black painted aluminium for aluminium doors ■ Flat 24x3 in stainless steel for aluminium/iron doors ■ Flat 22x3 in stainless steel for aluminium doors <p>Multipoint locks with adjustable height starting from 2300 mm with sections:</p> <ul style="list-style-type: none"> ■ U 24x6 in stainless steel for aluminium doors ■ U 24x5 in stainless steel for iron doors ■ U 22x7 in aluminium for aluminium doors ■ Flat 24x3 in stainless steel for aluminium doors <p>Multipoint locks with fixed height starting from 1860 mm with sections:</p> <ul style="list-style-type: none"> ■ U 24x6 in stainless steel for aluminium/iron doors ■ Flat 24x3 in stainless steel for aluminium/iron doors <p>Extension with 4° point of closure, adjustable height up to 3220 mm with sections:</p> <ul style="list-style-type: none"> ■ U 24x6 in stainless steel for aluminium/iron doors ■ Flat 24x3 in stainless steel for aluminium/iron doors |

OPERATION

The key operates the deadbolts and the latchbolt (external/internal).
The handle disengages the latchbolt (internal).

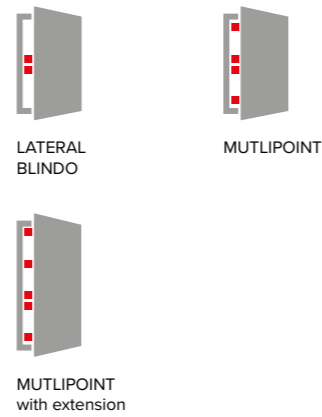

PLUS

Deadbolt with deadlocking system

In the event of a break-in attempt, the bottom-up load, exerted on the dead bolt

- moves its pivot point upwards
- sticks the deadbolt between the door and the frame

The door is definitively locked in an irreversible way.



Modular Lock

A central lock with a long front plate can be integrated with deviators chosen by the installer, for doors up to 2300 mm.

In addition, the lock can be equipped with the extension to an additional fourth locking point for doors up to 3220 mm.

This allows for more flexible storage.

Adjustable and Modular Latch

The lock is equipped with a reversible latch bolt and with a 5 mm adjustable projection, so it is functional for final adjustments in site.

The latch is modular and can be replaced by the roller or a plug for a lock deadbolt mode only, thus allowing more flexible storage.



MAIN ACCESSORIES AND MATCHING PRODUCTS*

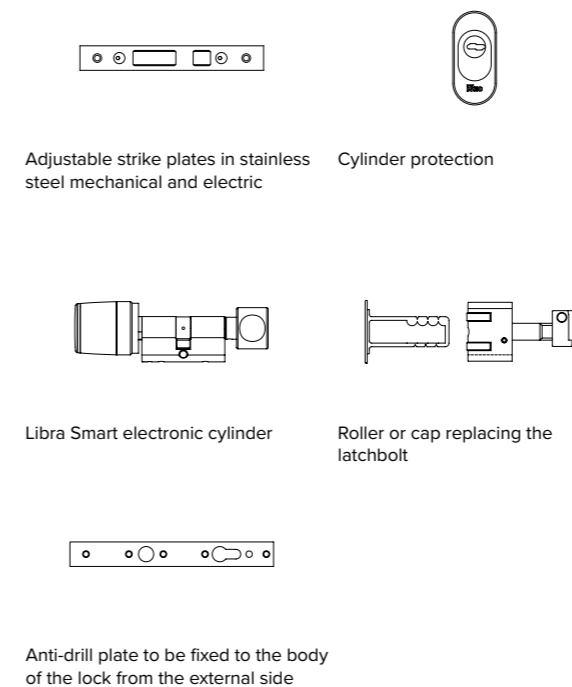

*to see the complete list of products which can be combined with Multiblindo, check the ISEO catalogue

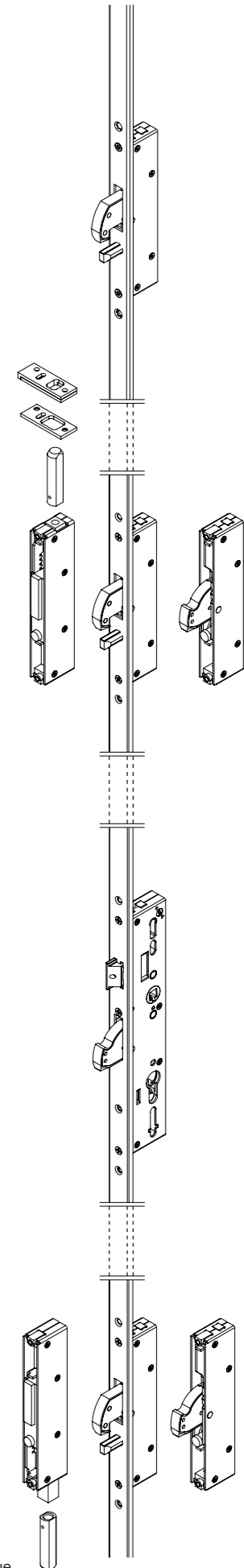

Extension

Multiblindo Classic

Multiblindo Easy - Easy EXIT

| | |
|------------------|---|
| Centre distances | 92 mm (94 mm with swiss cylinder) |
| Backsets | 35-40-45-50-55-60-65 mm |
| Handle | 8 mm Easy |
| Followers | 9 mm Easy EXIT (panic/escape routes) |
| Front plates | <p>Lateral locks with sections:</p> <ul style="list-style-type: none"> ■ U 24x6 in stainless steel for aluminium doors ■ Flat 24x3 in stainless steel for aluminium/iron doors <p>Multipoint locks with adjustable height leaves starting from 2300 mm or fixed lengths at 1860 mm with sections:</p> <ul style="list-style-type: none"> ■ U 24x6 in stainless steel for aluminium doors ■ Flat 24x3 in stainless steel for aluminium/iron doors <p>Extension with 4°/5° point of closure, adjustable height up to 3220 mm with sections:</p> <ul style="list-style-type: none"> ■ U 24x6 in stainless steel for aluminium/iron doors ■ Flat 24x3 in stainless steel for aluminium/iron doors |

Interchangeable with Classic

Microswitch to signal open/closed position of the deadbolts for Easy EXIT (panic lock)

Fixed latch, with right/left hand, with an increased distance from the trigger, for automatic deadbolt locking

OPERATION

By closing the leaf, the lock engages the deadbolts automatically.

From the inside, it is possible to exit by disengaging the latch and deadbolts by operating a handle (in the case of the Multiblindo Easy) or the panic bar or handle emergency handle (in the case of the Multiblindo Easy EXIT).

From the outside it is a prerequisite the use of a knob or a fixed handle; the entrance is allowed only by using the key which disengage the deadbolts and the latch. In the Easy version, by operating one key turn when the deadbolts are engaged, the inside handle can be locked.

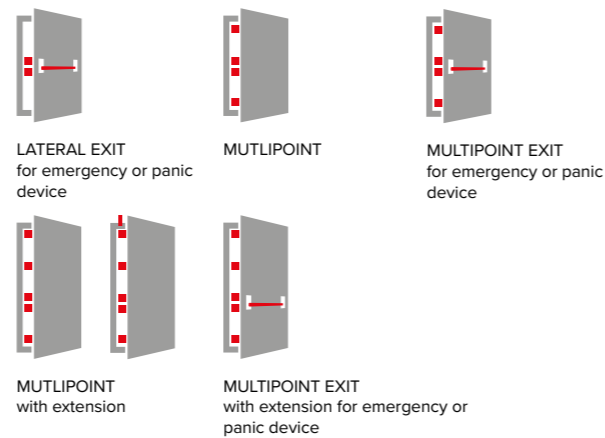

PLUS

Modular and self-locking locks

Multiblindo Easy and Easy EXIT can be integrated with the matching extensions, in the deviators versions with latch for fourth locking point and deviator with latch + provision for M8 rods with pin (only Easy version), for doors up to 3220 mm. Both locks are self-locking: by engaging the leaf, the lock arms the deadbolts automatically, guaranteeing peace of mind and security.

Customisable reclosure

The locks are equipped with three options of reclosing, which can be easily set at any time according to the daily use and requirements through a special mechanical selector placed on the front plate:

- **0-total** deadlock with deadbolts and latch completely and self-locking engaged.
- **1-light** partial reclosing with only the latch, to be used in high traffic conditions.
- **2-free** no re-locking, to leave the door always unlocked.



On the Easy version, it is possible to exclude the inside handle rotation through an additional key throw with the dead bolt out.

This prevents unauthorized intrusion through breaking of the door glass (security) a greater control over the exit.

Patented high performance system

A specific patented system allows the operation of the bolts only when the latch is engaged in the strike plate by at least 3 mm: in this way, the door is perfectly aligned, ensuring a longer service life.



MAIN ACCESSORIES AND MATCHING PRODUCTS*

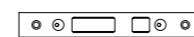

Adjustable strike plates in stainless steel mechanical

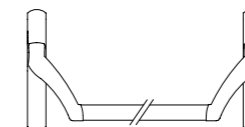

Pro EXIT panic bar combined with Easy EXIT is certified EN1125 for panic doors



Dorma PLUS and Premium handles, series 810** to be combined with Easy EXIT certified for emergency door according to EN179

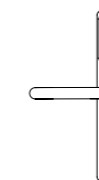

Aries electronic handle



Libra Smart electronic cylinder

*to see the complete list of products which can be combined with Multiblindo, check the ISEO catalogue

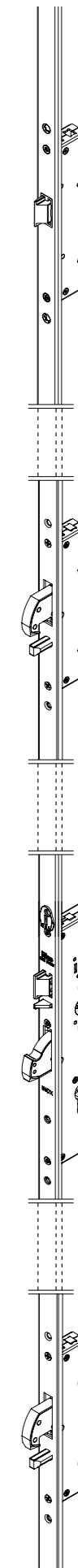

Extension

Multiblindo Easy

Multiblindo Emotion - Emotion EXIT

| | |
|------------------|---|
| Centre distances | 92 mm (94 mm with swiss cylinder) |
| Backsets | 35-40-45-50-55-60-65 mm |
| Handle | 8 mm Emotion |
| Followers | 9 mm Emoton EXIT (panic/escape routes) |
| Front plates | Multipoint locks with adjustable height leaves starting from 2300 mm or fixed with sections: <ul style="list-style-type: none"> ■ U 24x6 in stainless steel for aluminium doors ■ Flat 24x3 in stainless steel for aluminium/iron doors <p>Extensions with 4° point of closure, adjustable height leaves up to 3220 mm with sections:</p> <ul style="list-style-type: none"> ■ U 24x6 in stainless steel for aluminium/iron doors ■ Flat 24x3 in stainless steel for aluminium/iron doors |

Interchangeable with Classic and Easy Versions

Microswitch to signal open/closed position of the deadbolts for Emotion EXIT (panic lock)

Fixed latch, with right/left hand, with an increased distance from the trigger, for automatic deadbolt locking

OPERATION

In addition to the mechanical operation of self-locking door closing (the same as Multiblindo Easy), there is the motor that allows the opening through electronic access control.

From the inside it is possible to open by disengaging latch and deadbolts, through the action of the motor, which can be controlled electronically or by operating a handle (Multiblindo Emotion), or the panic bar, or emergency handle (Multiblindo Emotion EXIT).

From the outside it is possible to open without a key or handle but with electronic access control systems.

The key, however present and in this case with emergency function, always disengages mechanically the deadbolts and the latch.

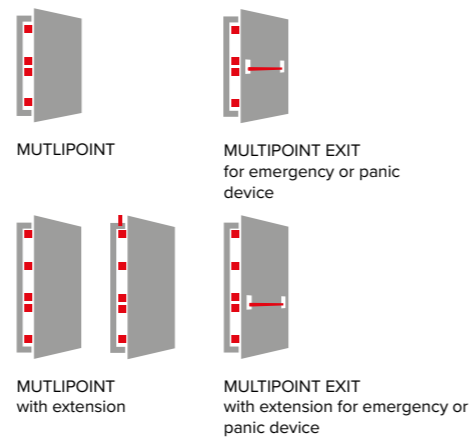

PLUS

Allows access control

The self-locking and electromechanical locks Multiblindo Emotion and Emotion EXIT can be combined with the most modern electronic access control systems available on the market.

Modular and self-locking locks

Multiblindo Emotion and Emotion EXIT can be integrated with the matching extensions, in the deviators versions with latch for fourth locking point and deviator with latch + provision for M8 rods with pin (only Emotion version), for doors up to 3220 mm. Both locks are self-locking: by closing the leaf, the lock engages the deadbolts automatically, guaranteeing peace of mind and security.

Customisable reclosure

Same as for Multiblindo Easy, these locks are equipped with three reclosing options, which can be easily electronically set at any time according to the daily use and requirements:

total, light and free.

On the Emotion version, it is possible to exclude the inside handle rotation through an additional key throw when the deadbolts are engaged. This prevents unauthorized intrusion through breaking of the door glass (security) a greater control over the exit

Patented high performance system

A specific patented system allows the operation of the bolts only when the latch is engaged in the strike plate by at least 3 mm: in this way, the door is perfectly aligned, ensuring a longer service life.



MAIN ACCESSORIES AND MATCHING PRODUCTS*

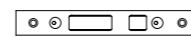

Adjustable strike plates in stainless steel mechanical

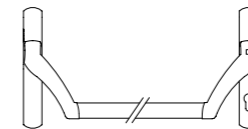

PRO EXIT panic bar combined with Emotion EXIT is certified EN1125 for panic doors

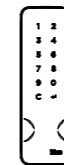

1NCA Readers Mullion



Argo app (for iOS and Android smartphones) and V364, LSA and Luckey access management software suites

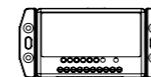

Smart Relay

*to see the complete list of products which can be combined with Multiblindo, check the ISEO catalogue

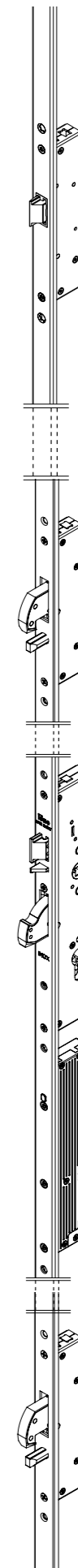

Extension

Multiblindo Emotion



ISEO Serrature s.p.a.
Via San Girolamo, 13
25055 Pisogne BS, Italy
Tel. +39 0364 8821
iseo@iseo.com

001117.EN - 02/2024.

Non-contractual document. Subject to change. Images for illustrative purposes only.

iseo.com